

QUALITY
INNOVATION
HEALTH
ENJOYMENT



KING TONY

ENJOY YOUR WORK



 KING TONY

2024/25 CATALOGUE



New products

Tools Storage & Tools System Sets

Hand Sockets & Accessories

Impact Sockets & Accessories

Pneumatic Tools

Torque Control & Multipliers

Wrenches

Pliers

Pipe Tools

Screwdrivers & L-wrenches & Bits

VDE Insulated Tools

Electronic & Electrical

Hammers & Striking Tools

Workshop Tools

Lighting

Automotive Tools

ST Series Tools

N1

NEW

16



134



232



264



290



316



350



364



374



424



434



468



476



500



516

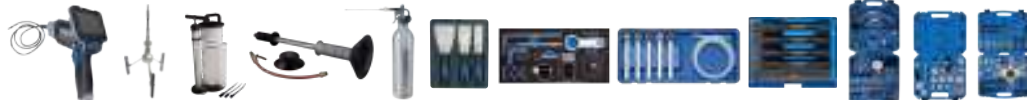

614



Company Profile

In 1976, amidst a lack of capital and technology in Taiwan, Mr. Charles Lai & Mr. Tony Lin founded a hot forge factory specializing in making hand tools for the DIY market. Eight years later, many other companies had followed their lead and although the market grew quickly, quality suffered. With pricing, costs and quality nearing a state of chaos it became clear to KING TONY's founders that they needed to seek a new direction.

Mr. Lai & Mr. Lin found their new direction; making professional quality hand tools built to compete with the best in the world. They set their standards high and in the years since, have consistently exceeded the requirements of the world's toughest standards. KING TONY tools don't just meet the DIN (German) standard and the ANSI (U.S.A.) standard, they routinely exceed them. In fact, we test every torque make to a standard 30% higher than that prescribed by DIN and our pneumatic impact tools to a 50% higher standard. That's true commitment to quality!

To further underscore our determination to compete with the best in the world we have achieved certification with ISO on three separate standards. First, in January 1998, ISO 9002, followed by ISO 9001 and more recently we have qualified for the environmental safety standard, ISO 14001. We believe that is our responsibility to the world and we will always dedicate to reduce the harm to the earth during our manufacturing process in the future.

You might sense that King Tony Tools is about much more than a world-class tool. The ideals of KING TONY's management are fulfilled daily by our hundreds of employee's at our branches and offices around the world. You will find KING TONY Tools and its branches in: France, Spain, Belgium, Mexico, China. Each of our local branch offices is tasked with insuring that you, our customer, are happy not just with our quality but with the experience of being a KING TONY customer.



1984
Hot
Forge



1989
Tougher
Design



1990
Color Code
Stripe



2023
World
Distribution

2015
Trustworthy
Brand



VISION >>>

KING TONY engaged in supplying professional tools for more than 38 years, we always focus on supplying quality tools to our customers to make sure the quality satisfies the working requirement. To finish a professional job is a dream and target for every mechanic, and to finish it more easily and perfectly is even a better achievement. Thus, every mechanic can really enjoy their work. From this motive we have a goal that is to make every mechanic know, when they use KING TONY professional tools, they will quickly, perfectly and easily finish their work. They may feel more of confidence and enjoy what they do. To achieve this goal, we will continue to supply tools that is easy to take, easy to use, save time and strength. Our future vision is to tell every mechanic who uses KING TONY tools "enjoy your work", which contains the meaning to use good tools to do good jobs and have real enjoyment in the process. Why not find your enjoyment from your job, take KING TONY professional tools and you will start to experience it.



1993
Super
Standard



1996
Close
Tolerance



1999
VDE
Safety
Grip



2012
Dual
Colors
Stripe



2007
Masters
of Torque

BE INSPIRED & MILESTONES



KING TONY

Enjoy your work



Distribution

Branches :

• **France :**

3 Rue des imprimeurs, ZI République Nord,
86000 Poitiers, France

• **Spain :**

Calle Valderribas, 14, Local Comercial Modo,
28007 Madrid, España

• **Belgium :**

Avenue Louise 143, Boîte 4, 1050 Bruxelles

• **Mexico :**

Av San Jose No. 15-A, Col. , Zona Industrial La
Presa, C.P. 54187 Tiainepantia, Edo. De Mexico

• **China :**

No. 3 Building, No. 285 Jingmao Rd.,
Industrial Park of Suzhou, Suzhou, Jiangsu, China



Intellectual Property

New Registered Trademark
Please recognize KING TONY's official registered trademark.

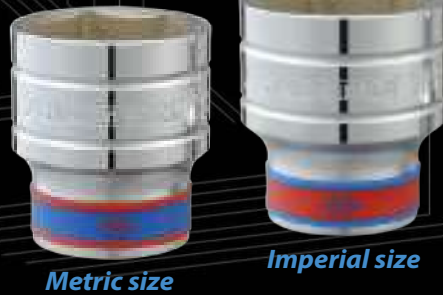

Inspection Equipment



01

Spectrometer

Metal material elements analysis



02

Gauge measurement

Measure the screw tap to meet LEVEL I tolerance of DIN standard



03

Rockwell hardness tester

Test the product's hardness to meet KING TONY quality standard



06

Torque tester

Fracture test to check the max. torque to ensure excess of DIN standard



07

Precise cutting machine

Cut for a smooth section



11

Environmental simulation test of temperature & humidity

Simulate temperature from 70 °C ~ - 20°C to test product reaction and durability while obvious change of temperature



12

Tension tester

Test pulling force of product especially for joint workpiece according to DIN standard



13

Hammering tester

Test the lifetime of striking hammer and security of the joint of hammer & wooden shaft



16

Micro-torque tester

Test products with smaller torque such as bits for their durability



17

Vision measuring machine

Measure parts for difficult angle or in the narrow space



04

Salt-water spray tester

48 HRs environmental simulation test to check product's durability from being rusty



05

Thickness test of plating

Apply special chemical to check thickness of plating and ensure it reaches KING TONY's standard



08

Mounting press machine

In order to fix tiny and multilateral workpiece



09

Grinding & polishing machine

Make surface of workpiece smoother and clearer for further observation



10

Micro-hardness tester

Analyze the change of metallography after heat treatment and the difference of hardness between surface and central location



14

Pliers class measure tester

Test the cutting force and durability



15

Torque wrench tester

Follow the DIN ISO & ASME standard to test torque tolerance by 3 points of the lowest point, 60%, and 100% of max. scale



18

Carton busting strength tester

Test the strength of carton in order to assure good packing quality



19

Insulated tester

Ensure products are insulated under the voltage 1000V

Production Process



01

Hot forge

Heat to take shape and complete fibers to improve durability



02

Lathing

Control sockets external diameter and the roundness



03

Drilling

Drilling pin hole on the groove to offer socket safety operation



06

Punching & Broaching

Make accurate dimension for the spanner



07

Marking

Stamp dimensions, material and manufacturer



11

Grinding

Remove oxide layer and ensure sockets roundness for follow process precision



12

Plating

Nickel-chrome plated to protect product from corrosion and improve finish



13

Phosphate sink

Increase impact sockets wear resistant and prevent corrosion to improve the durability



04

Machining (CNC)

Finish complicated process to ensure the precision of product



05

De-burring

Remove the burrs and chamfer on square hole



08

Heat treatment

Enhance product performance to achieve max. hardness



09

Vibrating

Remove oxide layer and burrs for surface coating



10

Sand blast

Remove oxide layer and burrs for surface coating



14

Silk printing

The unique bi-colors silk printing design and is easy to distinguish metric and imperial dimension



15

Rubber stripe assembly

The unique bi-colors rubber stripe design and is easy to distinguish metric and imperial dimension



Exhibitions



Sponsor & Partnership







Branding to Target Users



KING TONY TOOL TROLLEYS

SQUAD *Series*

KING TONY is very devoted to developing professional tools that meet user needs. In order to create a better storage for your professional tools, we have developed a new series of work station. From tool trolley to workbench, they are all the necessities for a professional mechanic

From industry, auto repair to general repair channel, we have visited countless users to hear their aspirations for tool storage. The purpose is to design the best meet needs product. It's consistent with our brand vision, "To provide professional tools to make customers feel comfortable and to help them with their work"

Just as our new series of tool trolley, the birth of this professional tool trolley series are to fulfill the needs of tool storage

Each model contain it's own characters for various of circumstances.

The ultimate purpose is to have them become your trustiest backup and support in your garage



Load bearing



- Overall supporting weight for tool trolley at a safety level



- Overall supporting weight for drawers at a safety level



Convenient



- Convenient and safety with Central lock system



- 100% drawer opening, does not interfere with the removal of tools



- 360° swivel wheel with brake function



- The size of the drawer conforms to TCS, and the tool set can be purchased freely according to the demand

Robustness



- Body frame are constructed with one-piece steel sheet for integral strength



- The bottom of the drawers are stamped in order to strengthen effectively

Protection



- Protection bumpers are for to avoid collisions and to protect object during maneuver



- Risk Free System (RFS) allows open one drawer at a time which prevents the loss of center of gravity from tilting and instability



- Press to open drawer is a safe and reliable system

SQUAD Tool Trolley

For time being, KING TONY has reached to another level of making tools trolley, in this year, we have invested a whole new direction for your satisfaction. Newly from concept to final product, from structure to finishing and even from top to bottom, we strive all our best into them

Start from the series name "SQUAD", it comes from the gaming industries, we believe this trolley can be extended to other business, and gaming is one of the potential market. This wording means a professional team which is us at KING TONY

This series have 4 models, Model D, Model D+, Model Dx, Model SW. Each model size are differ, storage space are not the same, it depends on your demand. Certainly one of them would fulfill your garage
This series of tools trolley is a milestone for KING TONY



- Shape and outline of bumpers correspond to the lid, which makes a connection in between, with cut through pattern shows more energetic outlook
- ABS corner protection bumper

- keylock usually in front or in the middle or side of the drawers, The reason we place in the corner is we have noticed that the keys will swing around while trolley was moving and scratched the surface of the trolley plus it altered the outlook

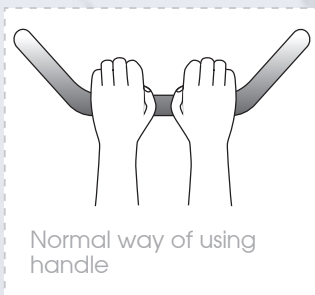

Normal way of using handle

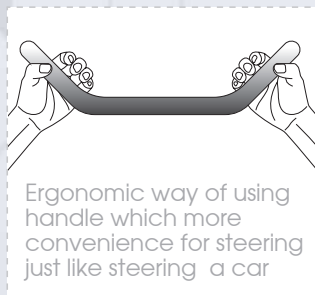

Ergonomic way of using handle which more convenience for steering just like steering a car

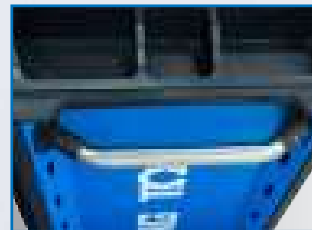

- Extra-large ergonomic handle



NEW

KING TONY

Model D

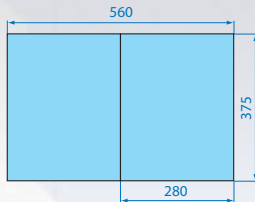

Model D^x

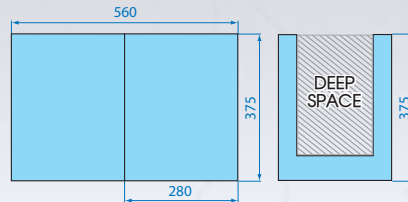

Model D⁺

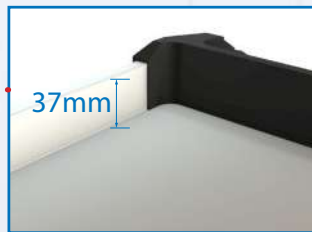
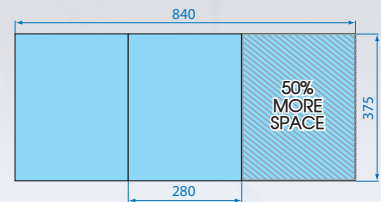

• Worktop depth has increased than previous models, parts are less likely to roll out



• Two models come in different size worktop



• Trapezoidal-shape storage space, easy to reach stuff



• Dual colors
• With brake systems



• Aluminum drawer strip, easy to pull out
The drawer is with auto closure function

Features

- Dynamic top cover
- Stainless steel worktop
- Structure strengthen
- Stylish bumpers
- Additional space for accessories
- Aluminum drawer handle
- RFS locking system (one drawer at a time)
- 5"x2" TPR high performance casters
- Central key lock
- 100% pull out drawer with auto-return



Model D

87SQ31

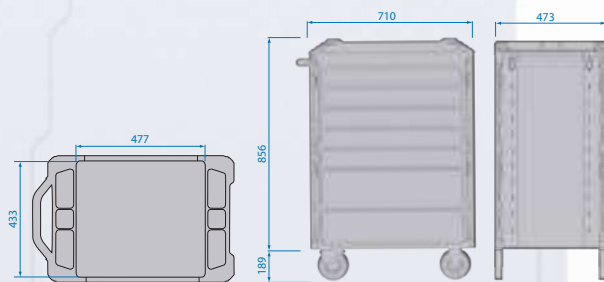
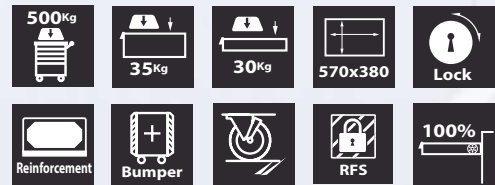

KT NO.	Spec.	Dimension(mm) Width x Depth x Height	Casters	Static load		CUFT
87SQ31-6B-BK	3 Drawers	570 x 380 x 70	5"x2"	500	63.00	14.30
	3 Drawers	570 x 380 x 150				
87SQ31-7B-BK	5 Drawers	570 x 380 x 70				
	2 Drawers	570 x 380 x 150				
87SQ31-8B-BK	7 Drawers	570 x 380 x 70				
	1 Drawers	570 x 380 x 150				

NEW

Model D^x

87SQ32

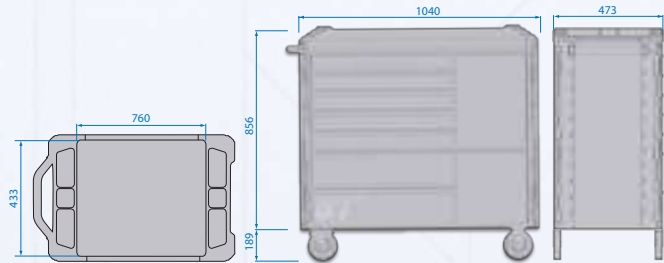
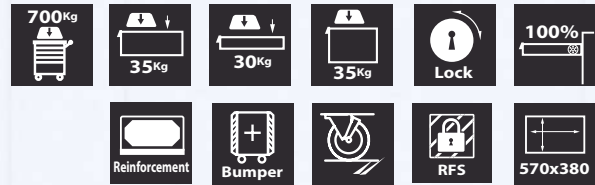

KT NO.	Spec.	Dimension(mm) Width x Depth x Height	Casters	Static load	kg	CUFT
87SQ32-8B-BK	3 Drawers	570 x 380 x 70	5"x2"	700	90.00	22.85
	3 Drawers	570 x 380 x 150				
	Square Drawer	270 x 380 x 280				
	Bulk Square Drawer	270 x 380 x 380				
87SQ32-9B-BK	5 Drawers	570 x 380 x 70				
	2 Drawers	570 x 380 x 150				
	Square Drawer	270 x 380 x 280				
	Bulk Square Drawer	270 x 380 x 380				
87SQ32-10B-BK	7 Drawers	570 x 380 x 70			94.5.00	
	1 Drawers	570 x 380 x 150				
	Square Drawer	270 x 380 x 280				
	Bulk Square Drawer	270 x 380 x 380				

Model D⁺

87SQ33

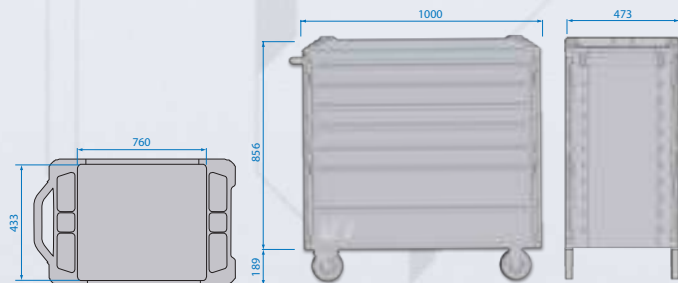
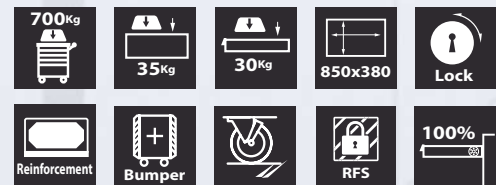

KT NO.	Spec.	Dimension(mm) Width x Depth x Height	Casters	Static load	kg	CUFT
87SQ33-6B-BK	3 Drawers	850 x 380 x 70	5"x2"	700	81.00	22.03
	3 Drawers	850 x 380 x 150				
87SQ33-7B-BK	5 Drawers	850 x 380 x 70				
	2 Drawers	850 x 380 x 150				
87SQ33-8B-BK	7 Drawers	850 x 380 x 70			91.00	
	1 Drawers	850 x 380 x 150				

NEW

KING TONY

Superb Workbench

Within this series, we are delighted to introduce new Superb workbench
An advanced model that absolutely would be no miss in your garage

Every inch of space can be used in this trolley,

It has enormous amount of storage space
equipped with 10 standard drawers, 1 peg board drawer, 3 cabinets with lock
Besides, unlike what you have seen in market, each side of this trolley are
functionable

Would be ideal for a team of professionals to share this tank and of course solitary is
also suitable

Furthermore, extra large and thickness working wooden top allows you to study your
products in details and longer durations without damaging body of the trolley

1 meter in height suits most people at a comfortable position

This highly functionable super tank are made for professional



- Doors cabinet with key lock for valuable electronic products
- Internal size : 654x376x205mm



- Able to fit other common accessories
Size 435x501mm



- Additional storage space



- Vertical wrenches peg board drawer for hanging wrenches vertically
- Internal size : 385mm x 378mm



- Paper roll trash bin or could be can/bottle holder
- Paper roll holder
Size 435x501mm

NEW

KING TONY

87SQ34-10B-BK

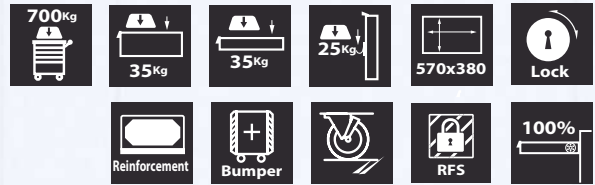

- Wide work top given 1235mm x 800mm space
- High end extra thick wood top
- Extra long metal handle bar for easy maneuver
- 10 drawers, plus 1 wrench hanging drawer
- 3 storage cabinets, from large to small for different storage purposes, all with key locks
- Able to fit other common accessories
- Absolute rectangular shape which fits every corner

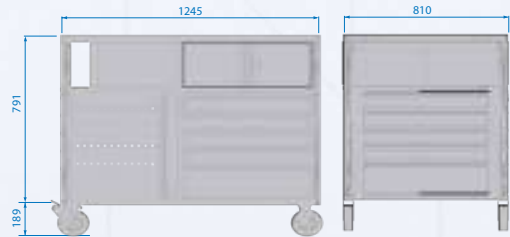

KT NO.	Spec.	Dimension(mm) Width x Depth x Height	Casters	Static load	Kg	CUFT
87SQ34-10B-BK	8 Drawers	570 x 380 x 70	5"x2"	700	130.00	41.63
	2 Drawers	570 x 380 x 150				



- Thickness: 32mm
- Size: 1235x800mm

- Extra long Handle bar

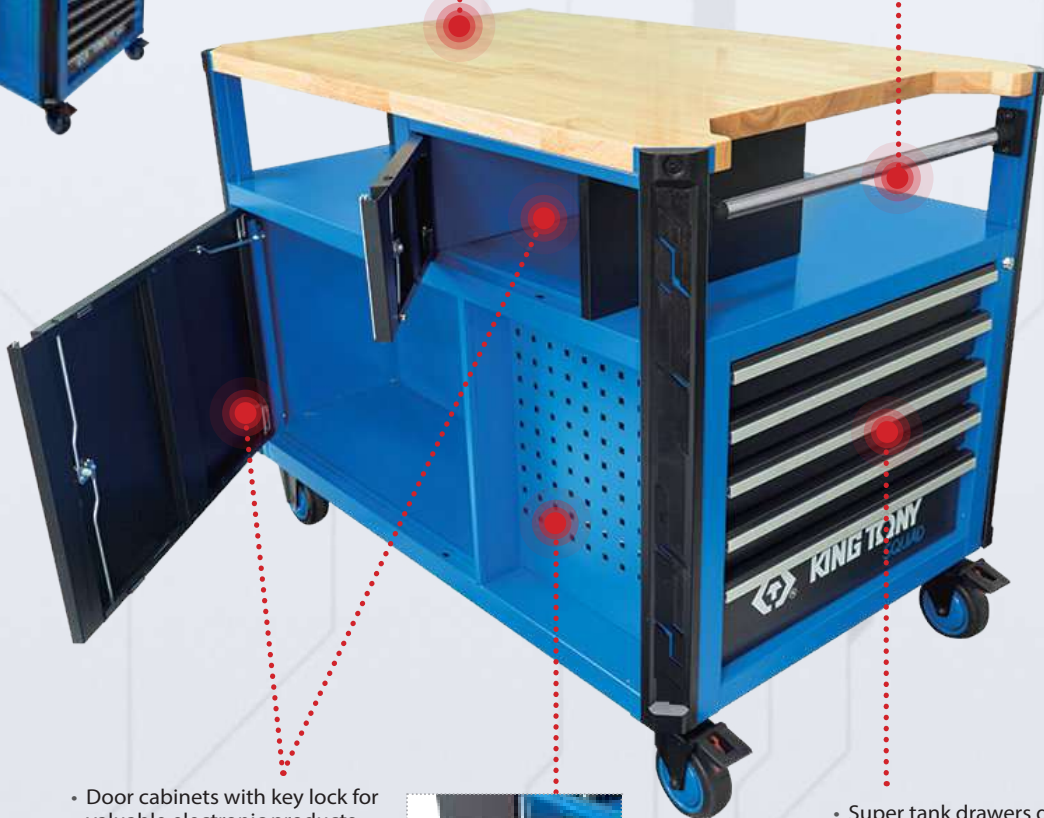

- Door cabinets with key lock for valuable electronic products
- Internal size: 389x406x202mm
- Internal size: 791x523x329mm



- Size: 426x499mm

- Super tank drawers dimension
- Internal size : 570x380x70mm
- Internal size : 570x380x150mm
- Multiple drawers at side

NEW

KING TONY

Accessories



Hook type

87SQ3-11



- Side pegboard
- If the right side of trolley do not have enough sufficient space, you might as well bought additional peg board for accessories (W)325 x(H)683

87SQ3-12



- Document holder (W)325 x(H)260 x(D)34

87SQ3-22



- Bottle holder (W)320 x(H)101 x(D)74

87SQ3-13

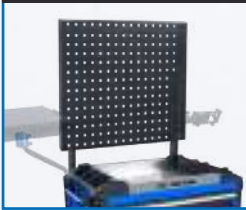

- Shelf pegboard (W)640 x(H)540

87SQ3-32



- Phone holder (W)200 x(H)52

87SQ3-31



- Laptop or ipad holder (W)378 x(D)285 x(H)79



- 3 angles of adjustment are available, 20°/45°/60°
- Can be turned left or right 360°



- Underneath the rack has a drawer for stationery storage



NEW

KING TOMY



Hook type

87SQ3-23

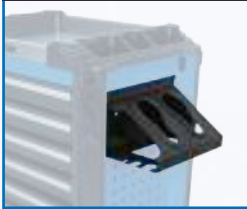

- Power tools holder (W)285 x(D)172 x(H)71

87SQ3-33

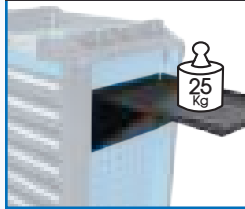

- Folding shelf (W)398 x(D)280 x(H)179

87SQ3-41



- Trash bin (W)275 x(D)150 x(H)136



- Left side of holder has three slots that are able to hang tools, hose or wrenches etc
- Right side of holder has 3 hooks for cleaning cloths, gloves, wires etc

87SQ3-42



- Trash bin-25 Liters (W)363 x(D)232 x(H)411
- handle slots on the side

87SQ3-51



- Paper holder (W)280 x(D)308
- For paper roll within 280mm wide



- Another strength of the accessories is that the paper roll can be inserted on top of the trash bin, which can be used both at the same time at the same place, it can also be used seperately. This combination makes more user friendly and unique for this trolley

Tool Set Content

9-91215MRV

Blow case size (mm) :
422 x 360 x 90 (0.48 cuft)

Contents		5.11	1 / 4
1062	27, 28, 29, 30, 32		
373A	8, 10, 11, 13, 17, 19, 22, 24		
3611-12R	6011-10R		



15
PC.

Tray category #6 (560 x 375mm)

Tool Set Content

934-086MRVD

86
PC.

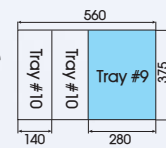
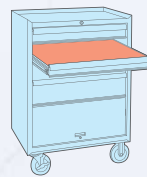

Drawer (579 x 380 mm)



9-12FVE15MRV #9 P.84



9-12FVG15MRV #9 P.84



9-40606GPV #9 P.85



9-55VE01MRV #9 P.84

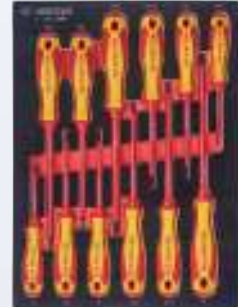

9-30612MRV #9 P.85



NEW

KINGSTON

Insulated Tool Set

Handy case size (mm) :
372 x 422 x 92 (0.51 cuft)

30VE31MPV 3/8"

Contents		4.21	1 / 3
3335VE	6, 7, 8, 9, 10, 11, 12, 13, 14, 15, 16, 17, 18, 19		
10FOVE	7, 8, 10, 12, 14		
3221VE	6, 10		
3771VE-08			
1471	VDE PH1 x 100, PH2 x 100		
1472	VDE 3 x 75, 4 x 100, 5.5 x 125		
6116-07A	6216-06A		
6318-08A	6CB02		

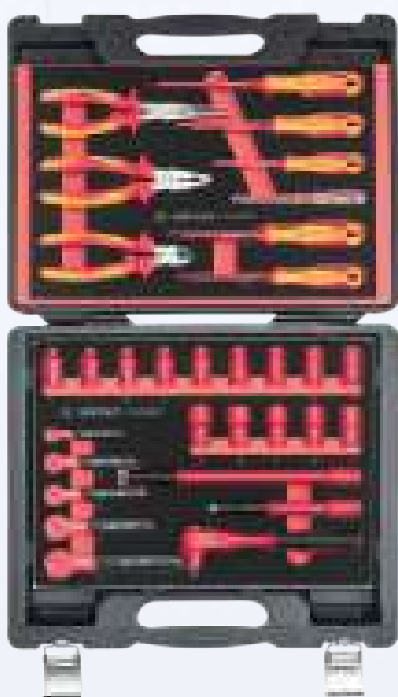

31
PC.

NEW

9-35VE02MRV 3/8"

Contents		1.52	1 / 10
3335VE	06, 07, 08, 09, 10, 11, 12, 13, 14, 15, 16, 17, 18, 19		
10FOVE	7, 8, 10, 12, 14		
3221VE	6, 10,		
3771VE-08			

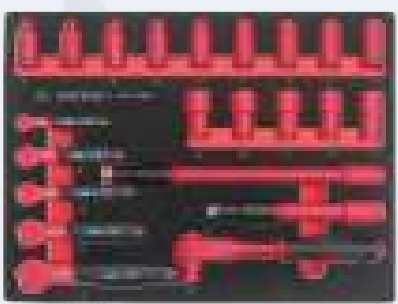

22
PC.

Tray category #9 (375 x 280mm)

9-90VE09CRV

Contents		1.20	1 / 10
1471	VDE PH1 x 100, PH2 x 100		
1472	VDE 3 x 75, 4 x 100, 5.5 x 125		
6116-07A	6216-06A		
6318-08A	6CB02		



9
PC.

Tray category #9 (375 x 280mm)

Wheel Nut Impact Socket & Set

44904MP01

1/2"

- Thin wall impact socket set with plastic sleeve
- Color coded, sizes are easy to recognize
- Material: Chrome molybdenum alloy steel
- The design of protective sleeve is able to reduce the wear of sheath and avoid damaging the aluminum alloy rims

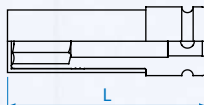

1.12 1 / 20



4 PC.

Blow case size (mm) :
160 x 135 x 50 (0.038 cuft)

Contents	DR.	Applicable vehicle	Size mm	L mm
494515M	1/2"	Smart	15	85.0
494517M	1/2"	-	17	85.0
494519M	1/2"	-	19	85.5
494521M	1/2"	-	21	85.5

44904MP02

1/2"

1.12 1 / 20

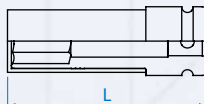

4 PC.

Blow case size (mm) :
160 x 135 x 50 (0.038 cuft)

Contents	DR.	Applicable vehicle	Size mm	L mm
494517M	1/2"	-	17	85.0
494519M	1/2"	-	19	85.5
494521M	1/2"	-	21	85.5
494522M	1/2"	Opel	22	85.0

Wheel Nut Impact Socket Set

44907MP

1/2"

1/2"

2.13 1 / 12

Contents	DR.	Applicable vehicle	Size mm	L mm
494515M	1/2"	Smart	15	85
494517M	1/2"	-	17	85
494519M	1/2"	-	19	85
494521M	1/2"	-	21	85
494522M	1/2"	Opel	22	85
9BW4501	1/2"	Mercedes Benz	17	85
9BW4502	1/2"	Hyundai/Kia	21	85



7 PC.

NEW

KINGTOMY

Impact Socket Set

4421MP1

1/2"

Contents

1.69 kg 1 / 12

4535M 10, 11, 13, 17, 19, 22, 24, 27, 29, 30, 32



11 PC.

Impact Socket Set

6424MP

3/4"

Blow case size (mm) :
422 x 360 x 90 (0.48 cuft)

Contents

11.58 kg 1 / 2

6535M 24, 27, 30, 32, 33, 34, 36, 38, 41, 46, 50, 55, 60, 65,



14 PC.

Brake Caliper Socket Set

9BC4A05MP

- Brake caliper socket set dedicated to Volkswagen, Audi and Porsche (VAG) vehicles.
- 10-tooth sockets: 11.5 mm - 15 mm - 20 mm
- 7-tooth socket: Ø 14 mm - 22 mm

1.18 kg 2 / 24

KT NO.	Specification (mm)	Applicable car models
9BC42A11	10-tooth : 11.5	Porsche
9BC42A15	10-tooth : 15	Audi Q7, S8 & Porsche Macan, Cayenne, Cayman
9BC42A20	10-tooth : 20	Audi A8, S6 & Porsche Cayenne
9BC41A14	7-tooth : 14	Audi Q7 and S4
9BC41A22	7-tooth : 22	Audi S5



5 PC.

Impact Bit Socket

8015M

KT NO.

mm

L mm

kg

1 / 24

801524M	H24	80	741	1 / 24
801527M	H27	80	776	1 / 24
801530M	H30	80	820	1 / 24
801532M	H32	80	851	1 / 24
801536M	H36	80	921	1 / 24

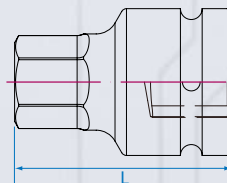

NEW

KING TONY

Brake Caliper Slogging Wrench

10B0B



- Use for the assembly and removal of the brake caliper screw connections on commercial vehicles
- Designed with a 3/4" DR., can be used with torque wrenches for tightening operations
- The torque adjustment formula laser etched onto the wrench for calculating the correct setting torque when tightening the fixings

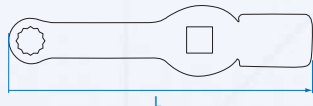

KT NO.	Size mm	Application	L mm		
10B0B-24	M24	SAF	215	580	1 / 24
10B0B-26	M26	DAF XF, XF95, XF105, XF106	220	580	1 / 24
10B0B-E18	E18	MAN TGL, TGM	215	580	1 / 24
10B0B-E20	E20	MAN TGL, TGM	215	580	1 / 24
10B0B-E24	E24	MAN TGA, TGS, TGX	220	580	1 / 24

Portable Wrench Set

KT NO.	PC.	Contents	Package		
12D06MRS01	6	1062 10, 11, 13, 14, 17, 19	color box	0.82	1 / 16

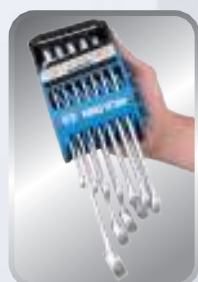

- Easy to recognize
- One-handed carry



- Quick storage
- Elastic structure design
- Hanging hole design



- Wrench safely locked in support

KT NO.	PC.	Contents	Package		
122A06MR	6	10, 12, 13, 14, 17, 19	color box	-	1 / 10
122A06MR01	6	373AM 8, 10, 12, 13, 14, 17	color box	1.12	1 / 10

NEW

KING TONY

4 in 1 Ratcheting Wrench & Set

3739J



- 4 sizes combine in 1 wrench, total 8 sizes as a set, common size for general applications
- Compact ratchet mechanism with reversible function
- 120-teeth precision ratchet gears only need minimal 3° to move fasteners
- Anti-slip teeth, suitable for 80% rounded bolt
- High quality durable chrome vanadium exceeds DIN standard
- Hexagon ring design provides a better torque capacity



Combine four general sizes in one wrench

Suitable for use confined space

Reversible ratchet with 120 teeth gear design

Anti-slip teeth, suitable for 80% rounded bolt

KT NO.	Size mm	D1 mm	D2 mm	H1 mm	H2 mm	L mm	⚖️	📦/📦
3739J0813M	8 x 10 x 12 x 13	22	26.6	13.5	16.4	169	117	12 / 192
3739J1619M	16 x 17 x 18 x 19	31	35	19.8	21.2	199	225	6 / 72

14902JMR01



2 PC.

KT NO.	PC.	Contents	⚖️	📦/📦
14902JMR01	2	8 x 10 x 12 x 13, 16 x 17 x 18 x 19	0.34	1 / 24

132A13MR01

Blow case size (mm) :
303 x 228 x 50 (1.35 Cuft)

Contents 1.64 1 / 8

373AM	8, 10, 11, 13, 14, 16, 17, 18, 19
	02H
	02R
	03R
	04R



13 PC.

Thread Repair File

75RF09M

- For the restoration of defective internal and external threads
- Suitable for right and left-handed thread
- Suitable for metric pitch: 0,80 - 1,00 - 1,25 - 1,50 - 1,75 - 2,00 - 2,50 - 3,00

164 12 / 120

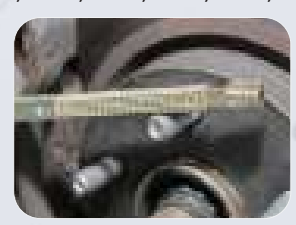

NEW

KING TONY

6PC. Adapter Set

78106

- According to DIN 3123 / ISO 3316
- Square drive adaptor to DIN 3120 / ISO 1174 with ball lock
- Internal square to DIN 3120 / ISO 1174 with ball reception
- For manual operation

1.31 kg / 1 / 20



M	Contents	F	M	Contents	F
3/8 DR.	2813	1/4 DR.	3/8 DR.	4813	1/2 DR.
1/4 DR.	3812	3/8 DR.	3/4 DR.	4816	1/2 DR.
1/2 DR.	3814	3/8 DR.	1/2 DR.	6814	3/4 DR.



6 PC.

6PC. Impact Adapter Set

786P06

- Square drive adaptor to DIN 3121 / ISO 1174 with ball lock
- Internal square drive to DIN 3121 / ISO 1174
- For machinery usage

1.31 kg / 1 / 20



M	Contents	F	M	Contents	F
3/8 DR.	2863P	1/4 DR.	3/8 DR.	4863P	1/2 DR.
1/4 DR.	3862P	3/8 DR.	3/4 DR.	4866P	1/2 DR.
1/2 DR.	3864P	3/8 DR.	1/2 DR.	6864P	3/4 DR.



6 PC.

NEW

KINGTOMY

Interchangeable Air Blow Gun Set



7
PC.

- Mini blow gun with 6pcs quick release nozzle tip
- Unique design control airflow output
- Venturi nozzle for produce X2.7 boost air flow
- Flat jet nozzle tip 42mm wide low noise under 85dBA
- 100mm non-scratch nozzle tip
- 100mm steel extension nozzle tip
- Conical rubber nozzle tip allow extension wear
- Safety venting nozzle tip control under 30psi
- Plastic case size (mm) :
207 x 170 x 55 (0.068 cuft)

Mini Air Blow Gun Set

7990A0

KT NO.	Air inlet inch	Working pressure PSI	Temperature range
7990A0	1/4"	90-120	-20°C to 85°C (-4°F to 185°F)



Contents

7990A0-P01(1/4" BSPT)
7990A1-P01(1/4" NPT)



7990A-P02



7990A-P03



7990A-P04



7990A-P05



7990A-P06



7990A-P07

NEW

KING TONY

Interchangeable Accessories

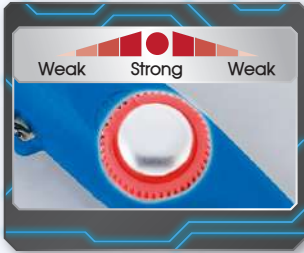

- Airflow adjusting knob (Mini type)

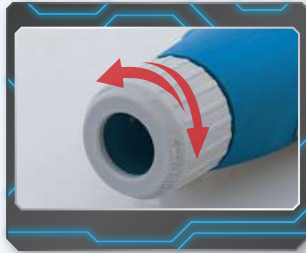

- Quick release

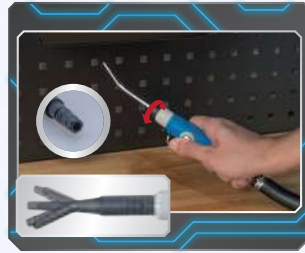

- Multi-angle adjustment for air blow direction (6 different angle, reduce the pressure to your wrist)

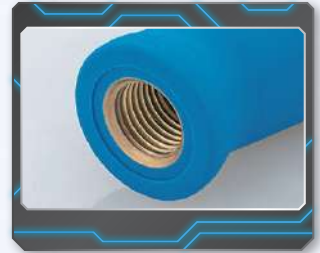

- Brass inlet

Mini Air Blow Gun

7990A0-P01 (1/4" BSPT)
7990A1-P01 (1/4" NPT)



7990A-P02

- Plastic nozzle
100mm, NY+GF. Ideal for any kind of project, avoid causing damage to object



7990A-P03

- Turbo nozzle
Special structure, increase 270% of airflow



7990A-P04

- Noise reduction nozzle (42mm)
Sound less than 85 Decibel, low noise level



7990A-P05

- Steel nozzle
ø6x100mm



7990A-P06

- Rubber nozzle
Preventing causing damage to object (Use with steel nozzle)



7990A-P07

- Safety venting nozzle
The pressure will be reduced to below 30PSI. It's to make sure the pressure won't cause damage to human body (Use with steel nozzle)



7990A-P08

- Storage rack



NEW

KING TONY

Screw Extractor Set

11015SQ

- Ideal tool for removing rounded/damaged/stuck bolts
- Material: 8660 steel
- Hardness: HRC49-52

0.53 kg 1 / 20

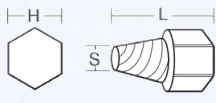

15 PC.

Hex size(H) mm	inch	Size(S) mm	Overall length(L) mm
12	1/8", 3/16", 1/4", 3/8"	3, 4, 5, 5.5, 6, 8, 10	29
16	1/2"	11, 12, 14	

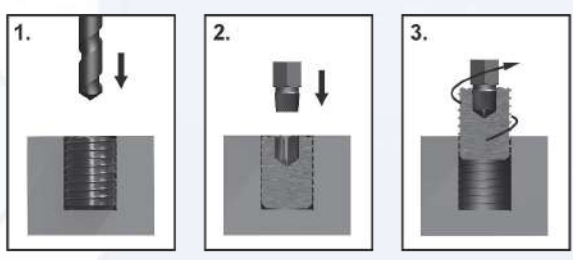

- Operation:
1. Drilling a hole which is 0.5mm bigger than the extractor on the bolt
 2. Insert the extractor in the bolt
 3. Turn counter clockwise to remove the bolt

Note: This is a manual operated tool, do not use with impact or power tools

Pipe Wrench

6522

- 90° Angle Clamping Jaws
- I-beam handle design
- Special hardened teeth
- DIN 5234

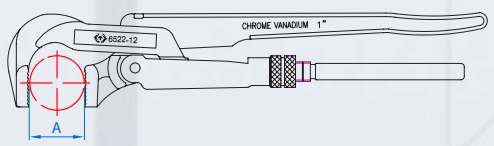

KT NO.	A mm	Size inch	Overall length		g	1 / 20
			inch	mm		
6522-12	45	1-3/4	12-1/2	320	693	1 / 20
6522-16	55	2-3/8	16-1/2	425	1265	1 / 20
6522-22	67	2-15/16	22	560	2210	1 / 10
6522-25	110	4-5/16	24-1/2	630	3000	1 / 4
6522-29	130	5-1/8	29	735	5290	1 / 2

NEW

KING TONY



- Optimized Charging Performance



- 200% Lumen Enhancement



- Significantly Enhanced Protection



6W COB LED & 1W SMD LED Rechargeable Inspection Light

9TA271

- 6W COB LED & 1W SMD LED
- White light color, Kelvin:6500K
- Switch mode:
 - Top light/Main light(low-high)/Off
- Material: Durable ABS+PC+TPE
- Rechargeable battery:3.7V 2600mAh Li-ion battery
- Charging time:3.5hours
- IP54 protection rating
- IK07 vandalproof
- EN62471 Photobiological safety
- Working temperature: -10° C to + 40° C

Switch mode	Lumen	Operating hours
Toplight	120 lm	12h
Main light-low	250 lm	6h
Main light-high	600 lm	3h

600 Lumen

6W

3-12h



Li-ion
2600 mAh
3.7V

TYPE-C
USB

IP54
IK07

3.5h

RoHS



KT NO.

L
mm



9TA271

260

186

1 / 20



• Battery indicator

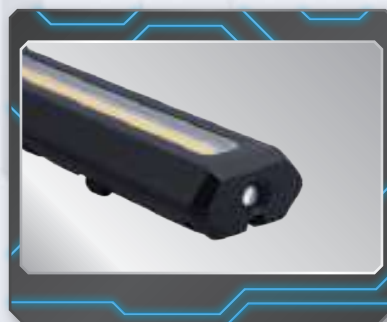

• Top light

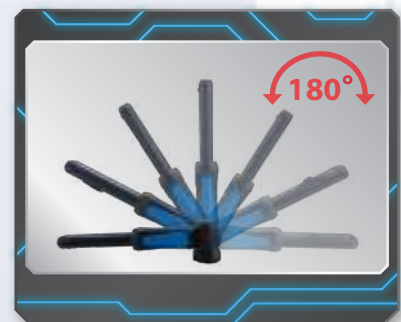

• Top light 180° swivel base with 6 positions



• Ergonomic Handle



• Strong bottom magnet with two functional hooks

NEW

KINGTOM

Ultra Compact Site Light

9TA48

- 30W COB LED
- White light color, kelvin : 6500K
- Rechargeable high quality 7.4V 5200mAh Li-ion
- Quick charging time : 4.5 hours
- Material : Aluminum Body, nylon stand and handle, rubber edge protector

3000 Lumen **30W** **2-25h**
Li-ion 5200mAh 7.4V **4.5h** **IP65 IK07**
CE **RoHS**



Switch mode	Lumen	Operating hours
Work light 20%	300 lm	25h
Work light 40%	750 lm	12h
Work light 60%	1500 lm	6h
Work light 80%	2250 lm	4h
Work light 100%	3000 lm	2h



- Input
- USB output (Power bank)



- Option to fixation

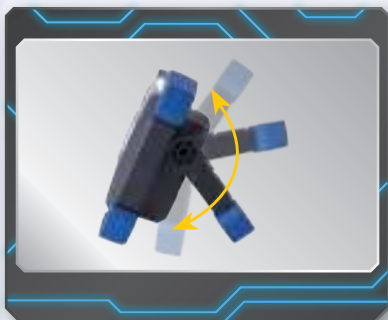

- 180° vertical rotation



- 5 LED battery level indicators, low power warning



- Tripod mountable (option tripod not included)

KT NO.	Applicable area	L x W x H mm	Icons	Contents	Quantity
9TA48A	Europe	205 x 153 x 75	960 1 / 8	30W floodlight with power bank	x 1 PC.
9TA48B	America & Asia	205 x 153 x 75	960 1 / 8	Type-C USB	x 1 PC.
9TA48D	Australia & New Zealand	205 x 153 x 75	960 1 / 8	5V/2A Charger	

Damaged Nuts Remover Socket Set

CAUTION Can't be used with pneumatic wrench

9TD033MR

1/2"

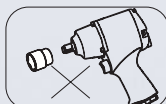

4 PC.

Contents 0.40 4 / 48

9TD403 17, 19, 21

NEW

KING TONY

Oil Filter Chain Wrench

3209

- Suitable for removing all kinds of oil filter on vehicles
- Chain design for easily removing stubborn oil filter

KT NO.	Capacity mm	kg	Box
3209-120	Ø 60~120	302	12 / 48
3209-135	Ø 60~135	333	12 / 48
3209-220	Ø 60~220	385	12 / 36



1/2"



Oil Filter Wrench for HGV Truck

9AE31X

- 1.Oil filter wrench design for high torque requirements
- 2.Use with a 1/2" square drive tool
- 3.Universal tool for HGV truck, bus, tractor and marine engines



KT NO.	Ø Capacity mm	kg	Box
9AE31X-120	105~118	500	6 / 24
9AE31X-135	118~130	667	6 / 24
9AE31X-145	130~143	750	6 / 24



Donna 改數據



- Strong steel band can be more stable on oil filter removal

NEW

KING TONY

Carbide Scraper & Set



9CJ74

- The blade tip is made of tungsten carbide material, which offers high hardness and a long lifespan. Available in 16mm and 32mm width.
- It can be used to scrape off residual carbon deposits, rust marks, or silicone residue from surfaces of objects, such as old silicone on oil sumps, exhaust manifolds, or brake calipers.
- The blade tip is equipped with a protective cover, and the rear end has a hanging hole.



KT NO.	A mm	inch	L mm		
9CJ7416	16	8	210	136	10 / 40

KT NO.	A mm	inch	L mm		
9CJ7432	32	8	210	165	10 / 40

9CJ072

KT NO.		
9CJ072	301	10 / 40



- Scrape off glue.



- Scrape off rust.



- The blade tip has been finely ground on all four sides, allowing for both pushing and pulling motions.



- Designed with ergonomic handle to conform to human ergonomics, providing a comfortable grip.

NEW

KING TONY

Display Shelf Magnets

ADVT-03X

Size: 960x55(mm)

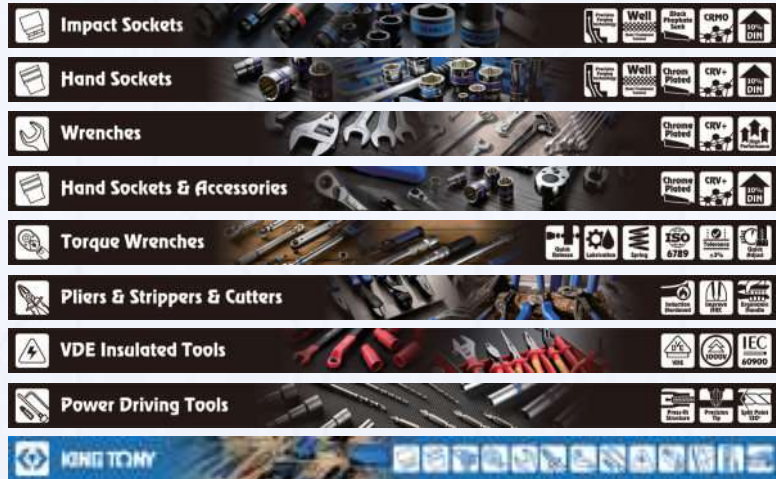

ADVT-031
ADVT-032
ADVT-033
ADVT-034
ADVT-035
ADVT-036
ADVT-037
ADVT-038
ADVT-039

Tools Display Card

ADVT-04

ADVT-05

Size: 900x240(mm)



ADVT-04



ADVT-05

NEW

KING TONY

Personal Cooler Bag

ZS120-S

- Size : 290 x 150 x 210 mm
- Weight : 352g



Door mat

ZS417

- Size : 600 x 900 x 8mm PVC



Mat

ZS418K

- Size : 700 x 500 x 2 mm

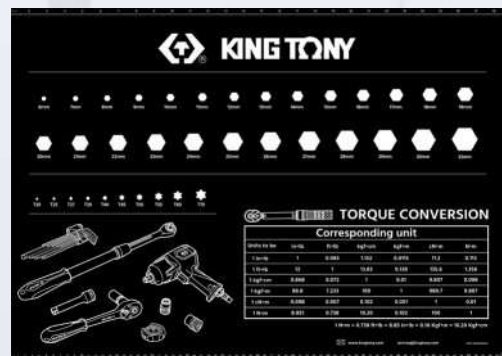

Mug

ZS606

- Size: 900x240(mm)
- Capacity:550ml



NEW

KING TONY

TOOLS STORAGE & TOOLS SYSTEM SETS







OBJECT-ORIENTED ORGANIZATION

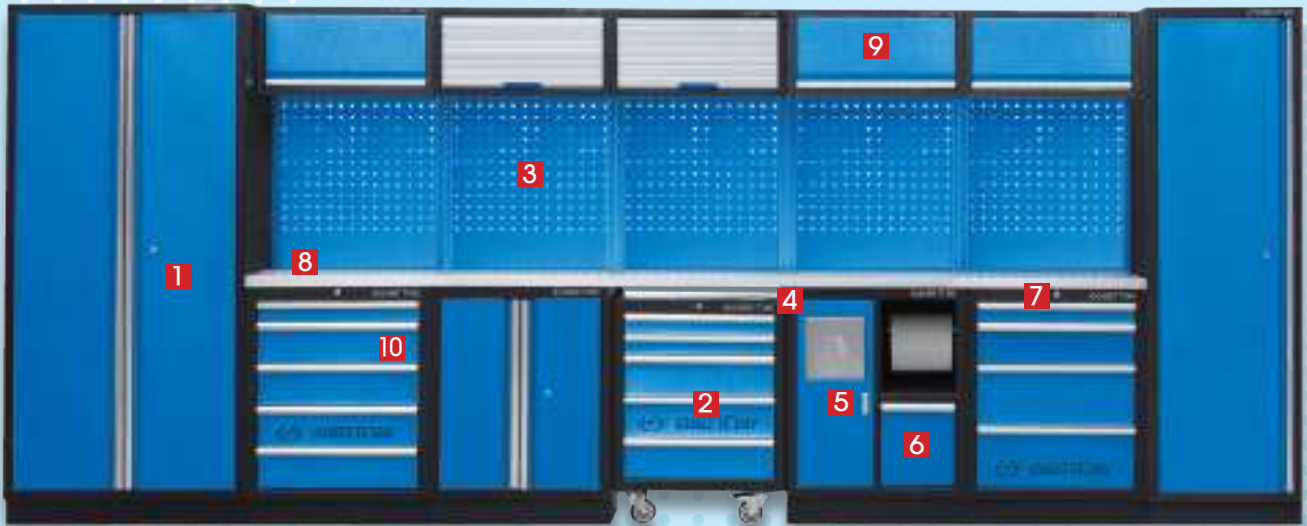

1 Flexible / adjustable shelves



2 Ball bearing slides

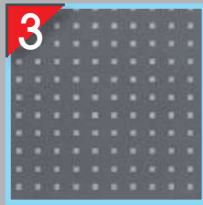

3 Steel panel for tool storage



4 Concealed handle



5 Hidden knob



6 Double volume



7 Front centralized locks



8 Stainless steel work surface



9 Cupboard with gas spring



10 The drawer with capacity 30kg



OBJECT-ORIENTED ORGANIZATION



87D11X01SA-KG

Overall: 4885 x 460 x 2000 mm

462.23 Kg CUFT 116.75



87D11X01SA-KB

Overall: 4885 x 460 x 2000 mm

462.23 Kg CUFT 116.75





OBJECT-ORIENTED ORGANIZATION

87D11X02SA-KG

Overall: 4235 x 460 x 2000 mm

400.87 kg CUFT 100.23

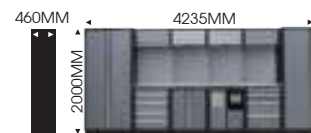

87D11X02SA-KB

Overall: 4235 x 460 x 2000 mm

400.87 kg CUFT 100.23





OBJECT-ORIENTED ORGANIZATION



87D11X03A-KG

Overall: 2955 x 460 x 2000 mm

262.26 CUFT 71.39

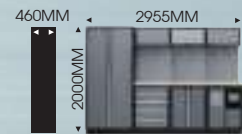

87D11X03A-KB

Overall: 2955 x 460 x 2000 mm

262.26 CUFT 71.39

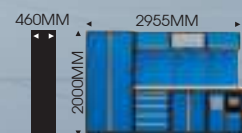



OBJECT-ORIENTED ORGANIZATION

87D11X04A-KG

Overall: 2640 x 460 x 2000 mm

⚖️ 248.60 CUFT 64.91



87D11X04A-KB

Overall: 2640 x 460 x 2000 mm

⚖️ 248.60 CUFT 64.91

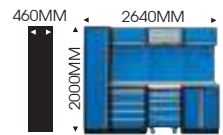

87D11X05A-KG

Overall: 2275 x 460 x 2000 mm

⚖️ 202.50 CUFT 51.83



87D11X05A-KB

Overall: 2275 x 460 x 2000 mm

⚖️ 202.50 CUFT 51.83





OBJECT-ORIENTED ORGANIZATION



87D11A-KG

Overall: 3920 x 460 x 2000 mm

kg 351.57 CUFT 89.35



87D11A-KB

Overall: 3920 x 460 x 2000 mm

kg 351.57 CUFT 89.35

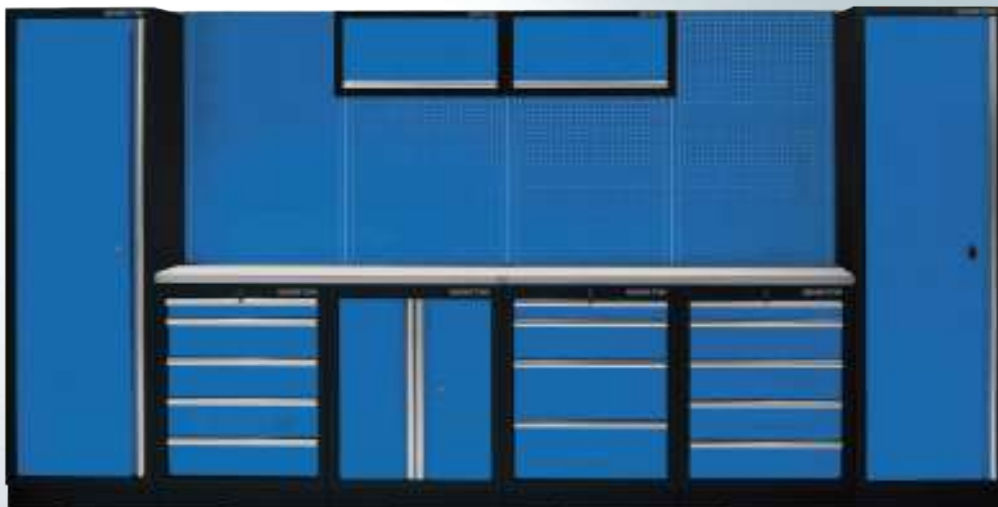



OBJECT-ORIENTED ORGANIZATION ACCESSORIES

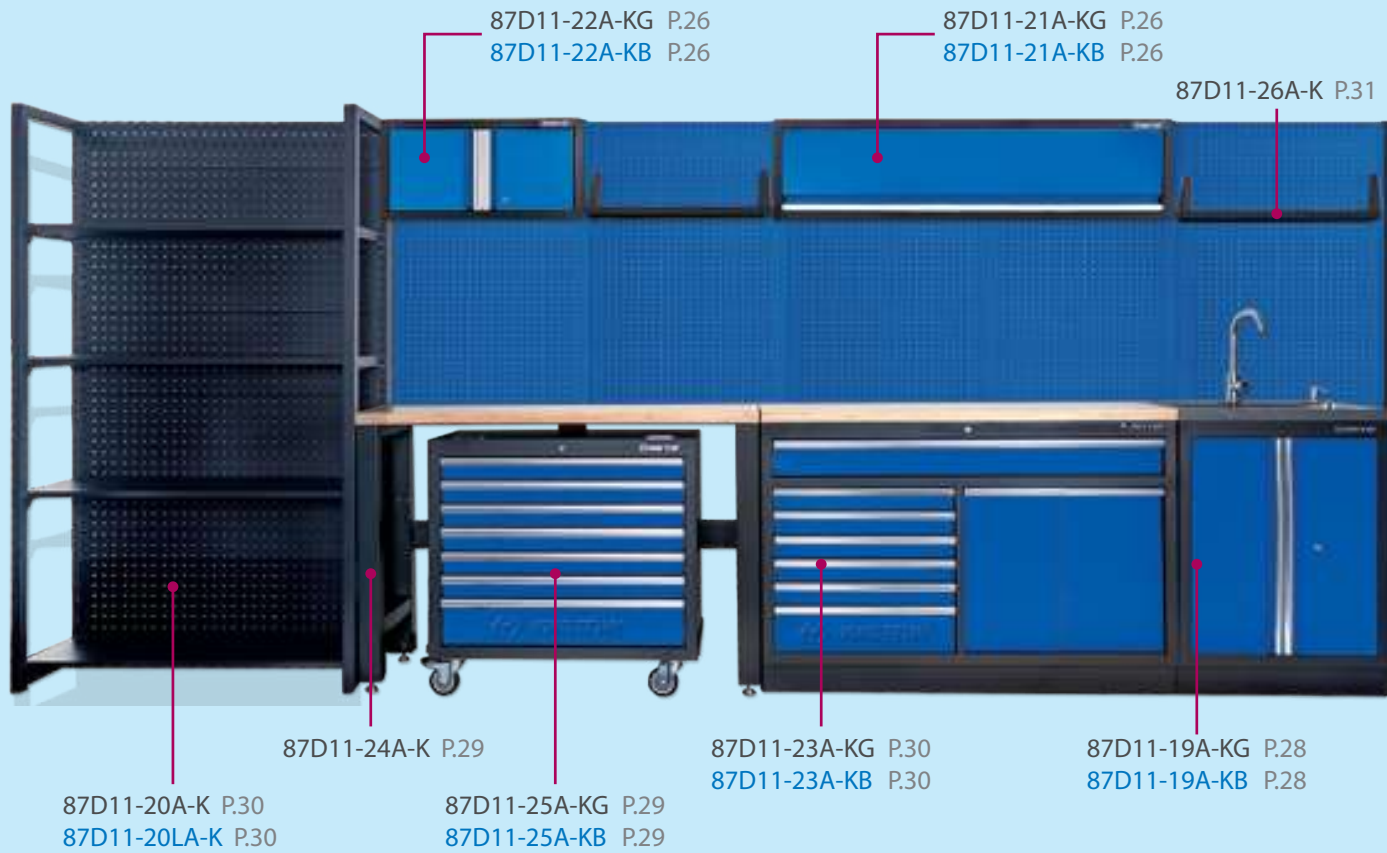

Tall Cabinet

87D11-02A-KG

87D11-02A-KB



KT NO.	Overall (mm)	Kg	CUFT
87D11-02A-KG	600 x 460 x 2000	53	9.28
87D11-02A-KB			

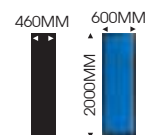

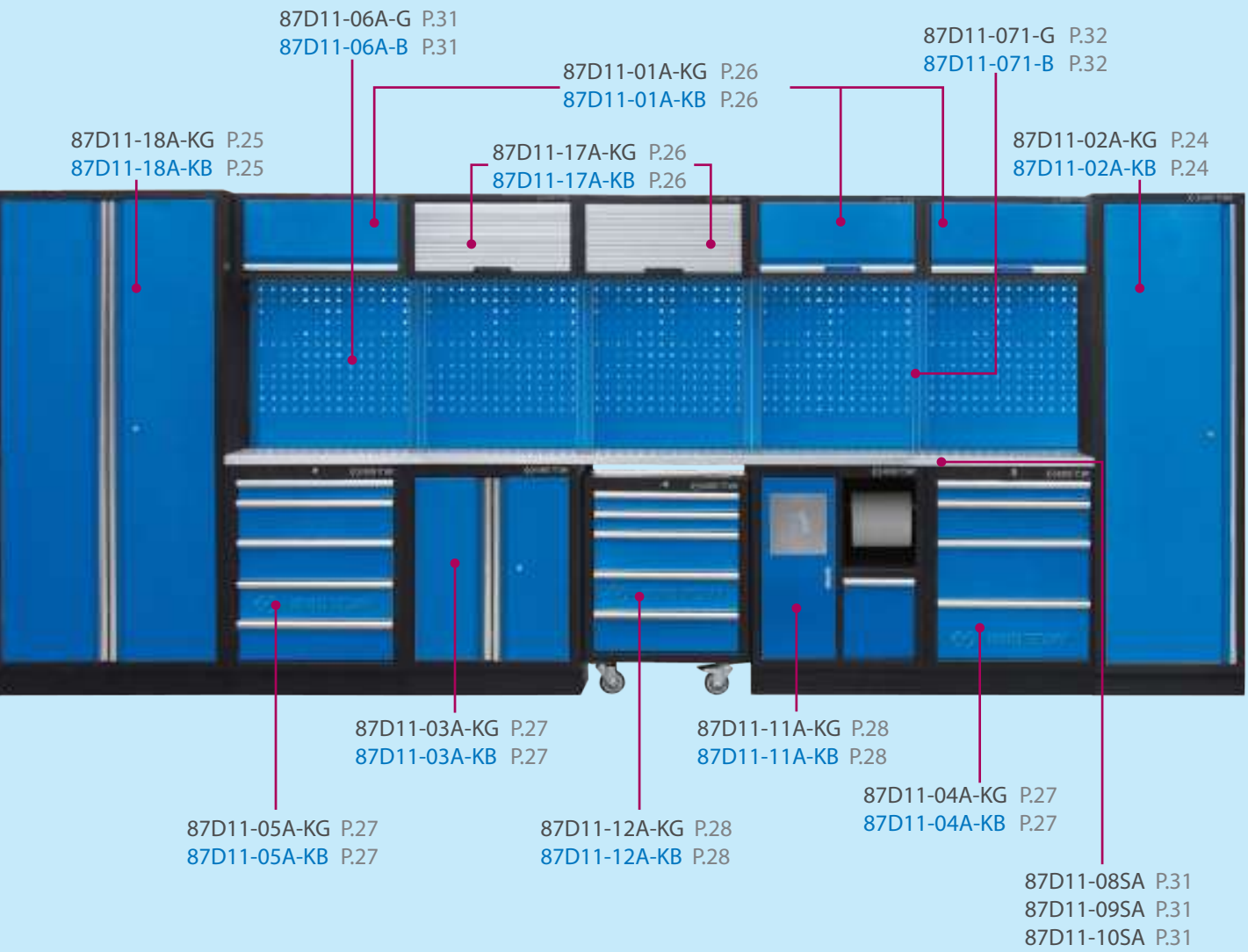

Tall Cabinet

87D11-18A-KG

87D11-18A-KB



87D11-18A-KG



87D11-18A-KB

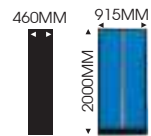

KT NO.	Overall (mm)	 Kg	CUFT
87D11-18A-KG	915 x 460 x 2000	78	12.72
87D11-18A-KB			



Extra Wide Wall Cabinet

87D11-21A-KG



87D11-21A-KG

KT NO.	Overall (mm)	Kg	CUFT
87D11-21A-KG 87D11-21A-KB	1360 x 281 x 350	17	7.24

87D11-21A-KB



87D11-21A-KB

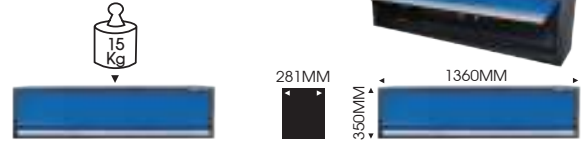

Wall Cabinet

87D11-01A-KG



87D11-01A-KG

87D11-17A-KG



87D11-17A-KG

87D11-22A-KG



87D11-22A-KG

Rolling Shutter

87D11-01A-KB



87D11-01A-KB

87D11-17A-KB



87D11-17A-KB

87D11-22A-KB



87D11-22A-KB

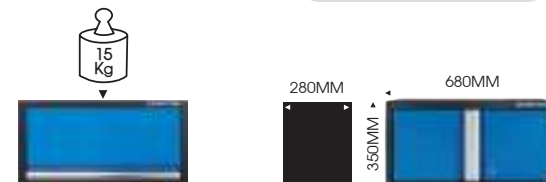

KT NO.	Overall (mm)	Kg	CUFT
87D11-01A-KG 87D11-01A-KB	680 x 280 x 350	10.0	3.73
87D11-17A-KG 87D11-17A-KB		8.4	
87D11-22A-KG 87D11-22A-KB		9	



Opened Door Cabinet

87D11-03A-KG



87D11-03A-KG



87D11-03A-KB

87D11-03A-KB



KT NO.	Overall (mm)		CUFT
87D11-03A-KG	680 x 460 x 910	28.5	13.58
87D11-03A-KB			

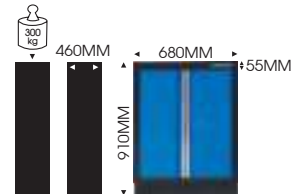

Drawer Cabinet

87D11-04A-KG

87D11-04A-KB



87D11-04A-KG



87D11-04A-KB

87D11-05A-KG

87D11-05A-KB



87D11-05A-KG



87D11-05A-KB

KT NO.	Spec.	Overall (mm)		CUFT
87D11-04A-KG	4 Drawer	680 x 460 x 910	46.70	13.58
87D11-04A-KB				
87D11-05A-KG	5 Drawer	680 x 460 x 910	49.30	13.58
87D11-05A-KB				

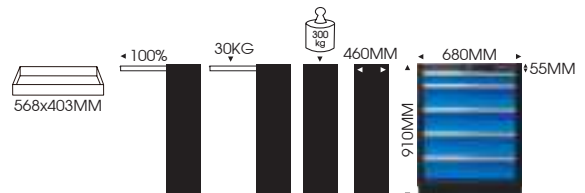
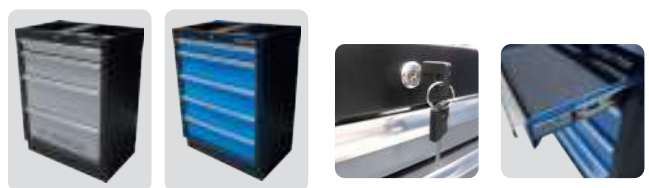



Trash Bin With Paper Holder

87D11-11A-KG

87D11-11A-KB



87D11-11A-KG

87D11-11A-KB

KT NO.	Overall (mm)	Kg	CUFT
87D11-11A-KG	680 x 460 x 910	35.20	13.58
87D11-11A-KB			

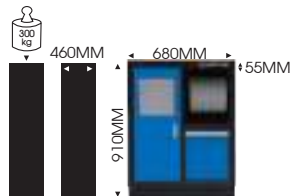

5 Drawers Cabinet

87D11-12A-KG

87D11-12A-KB

- Four swivel casters (one is with brake mechanism)



87D11-12A-KG

87D11-12A-KB

KT NO.	Spec.	Overall (mm)	Kg	CUFT
87D11-12A-KG	5 Drawer	650 x 460 x 862	46	10.41
87D11-12A-KB				

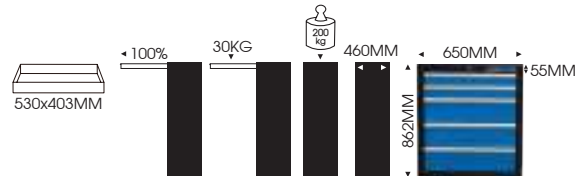

Washbasin Cabinet

87D11-19A-KG

87D11-19A-KB

- Water tap & Stainless steel sink, easy to clean
- Convenient two door cabinet



87D11-19A-KG



87D11-19A-KB



KT NO.	Overall (mm)	Kg	CUFT
87D11-19A-KG	680 x 464 x 948	33	14.23
87D11-19A-KB			

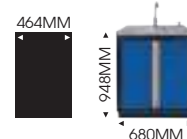



Workbench Frame

87D11-24A-K

- Workbench frame is able to combine with tool cabinet 87D11-25A-KG
- Suitable for use with workbench table(87D11-08A)

The workbench table is not included ✗

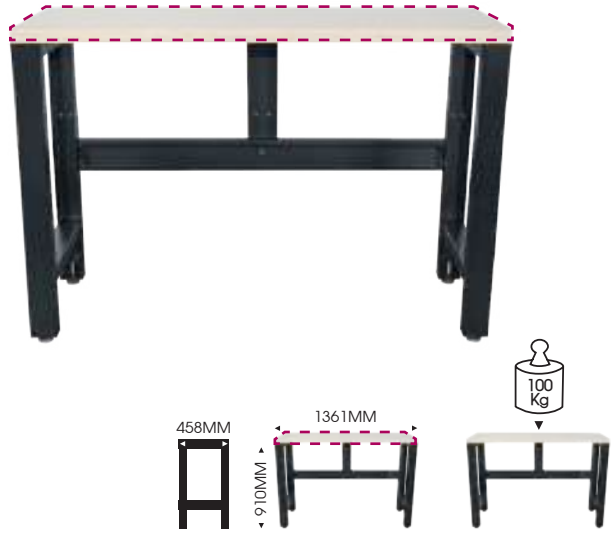

KT NO.	Overall (mm)	KG	CUFT
87D11-24A-K	1361 x 458 x 910	19.5	4.22

7 Drawer Tool Cabinet With Casters

87D11-25A-KG

- Suitable for use with workbench 87D11-24A-K
- 35in wide drawer, increasing the storage space
- Four swivel casters(one is with brake mechanism)

87D11-25A-KB



87D11-25A-KG



87D11-25A-KB



KT NO.	Spec.	Overall (mm)	KG	CUFT
87D11-25A-KG 87D11-25A-KB	Overall	895 x 460 x 732	65	14.07
	1 Drawer	785 x 403 x 137		
	6 Drawer	785 x 403 x 58		

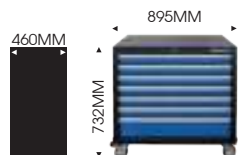

350 Kg



- The groove design is easy to pull out the cabinet



9 Drawer Bottom Cabinet

87D11-23A-KG

87D11-23A-KB

- 53 inch wide cabinet, with one wide drawer, six drawers, two big drawer
- Content with garage bin & storage box*18 PC.



87D11-23A-KG



87D11-23A-KB

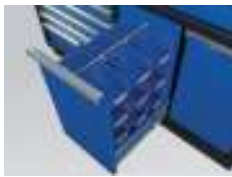

• Storage box



• Garage bin

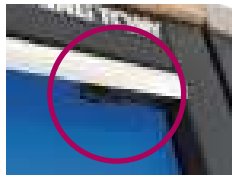

• Safety mechanism

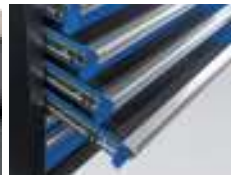

KT NO.	Spec.	Overall (mm)	Kg	CUFT
87D11-23A-KG	Overall	1360 x 465 x 948	112	29.77
	1 Drawer	1272 x 403 x 84		
87D11-23A-KB	5 Drawers	783 x 403 x 58		
	1 Drawer	783 x 403 x 137		
	2 door	284 x 371 x 531		

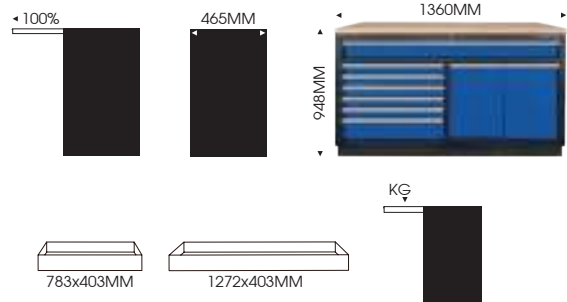

Storage Shelves

87D11-20A-K

87D11-20LA-K

- Multi-layer to storage
- Suitable for combine with 87D11 tool cabinet system



87D11-20A-K



87D11-20LA-K

KT NO.	Overall (mm)	Kg	CUFT
87D11-20A-K	680 x 458 x 2000	41	5.94
87D11-20LA-K	1200 x 458 x 2000	55	5.94

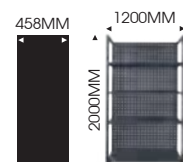
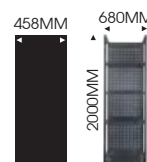
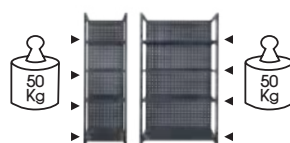



Storage Shelves

87D11-26A-K

- Wall tray for back panel, easy to storage

KT NO.	Overall (mm)			CUFT
87D11-26A-K	602 x 281 x 178	2.6	1 / 4	1.71

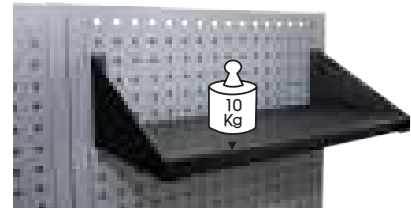

Pressed Wooden Board

87D11-08A

KT NO.	Overall (mm)	CUFT
87D11-08A	1360 x 465 x 38	12.5
87D11-09A	2042 x 465 x 38	19.0
87D11-10A	681 x 463 x 38	6.0

87D11-09A

87D11-10A



Stainless Board

87D11-08SA

KT NO.	Overall (mm)		CUFT
87D11-08SA	1360 x 465 x 38	21.0	1.61
87D11-09SA	2042 x 465 x 38	31.80	2.39
87D11-10SA	681 x 463 x 38	10.50	0.81

87D11-09SA

87D11-10SA



Back Panel

87D11-06A-G

KT NO.	Overall (mm)		CUFT
87D11-06A-G	615 x 25 x 1052	5.3	1.13
87D11-06A-B			

87D11-06A-B

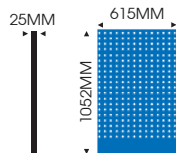

87D11-06A-G

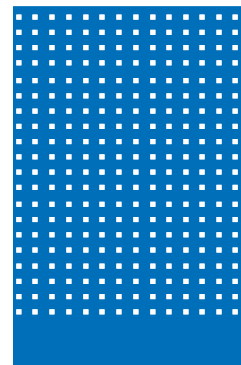

87D11-06A-B



Pillar

87D11-071A-G

87D11-071A-B

KT NO.	Overall (mm)	KG	CUFT
87D11-071A-G	33 x 30 x 1420	1.5	0.13
87D11-071A-B			

87D11-071A-B

87D11-071A-G

Optional accessories

87D11X06SA-KG

87D11X06A-KG

87D11X06SA-KB

87D11X06A-KB

Corner Bottom Cabinet

87D11-13A-KG

87D11-13A-KB



KT NO.	Overall (mm)	KG	CUFT
87D11-13A-KG	865 x 865 x 910	42	7.06
87D11-13A-KB			

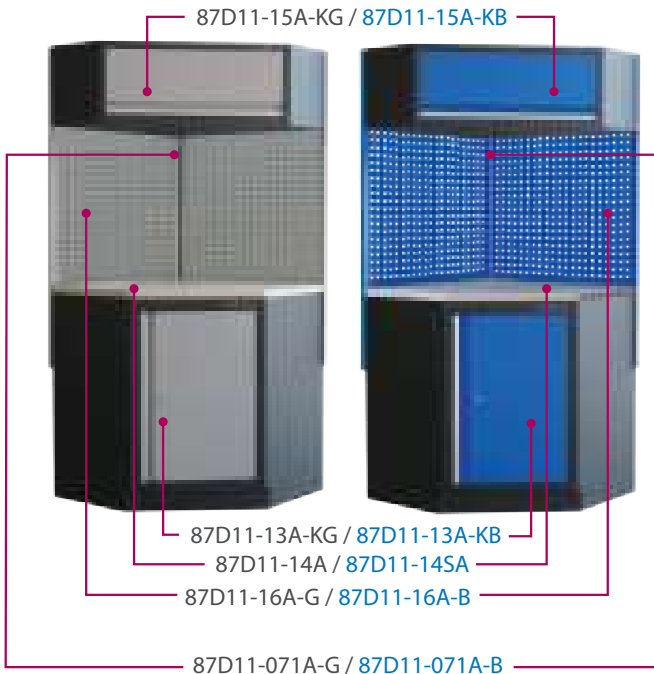
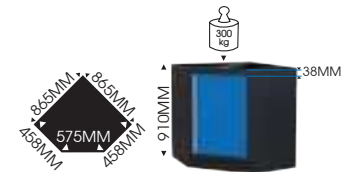

Corner Wall Cabinet

87D11-15A-KG

87D11-15A-KB

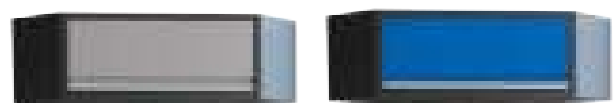

KT NO.	Overall (mm)	KG	CUFT
87D11-15A-KG	865 x 865 x 350	21	12.70
87D11-15A-KB			





Stainless Steel Board

87D11-14SA



KT NO.	Overall (mm)	Kg	CUFT
87D11-14SA	865 x 865 x 38	19	1.94

Pressed Wooden Board

87D11-14A



KT NO.	Overall (mm)	Kg	CUFT
87D11-14A	865 x 865 x 38	13	1.94

Corner Back Panel

87D11-16A-G

87D11-16A-B



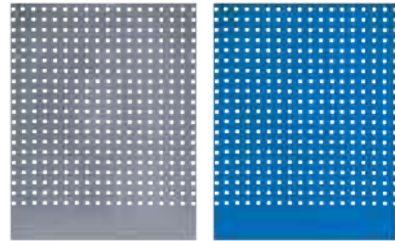
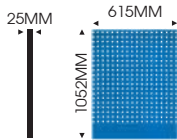

KT NO.	Overall (mm)	Kg	CUFT
87D11-16A-G 87D11-16A-B	800 x 25 x 1052	6.95	1.45



Adjusting Feet

KT NO.	Contents	Kg
87D11-05A-10	 <ul style="list-style-type: none"> ▪ Pack by 4 PC. 	700

Hook

KT NO.	Contents	Kg
87E02-051A	 <ul style="list-style-type: none"> ▪ 1" Single hook ▪ Pack by 10 PC. 	20
87E02-053A	 <ul style="list-style-type: none"> ▪ 3" extra long single hook ▪ Pack by 10 PC. 	30
87E02-061A	 <ul style="list-style-type: none"> ▪ 1" Double hook ▪ Pack by 10 PC. 	50
87E02-063A	 <ul style="list-style-type: none"> ▪ 3" extra long double hook ▪ Pack by 10 PC. 	68



Tool Trolley

KT NO.	Loading 	Wheel 	Work top 	Drawers 	100% Open 	Risk-free 	Bumper 	Auto-return 	INDEX
--------	-------------	-----------	--------------	-------------	---------------	---------------	------------	-----------------	-----------

L	87432-B	360	5"X1-1/4"	Cutting mat	5 / 7	●	X	-	-	P.37
	87434-B	360	5"X1-1/4"	Cutting mat	5 / 7	●	X	-	-	P.37
	87432-G	680	5"X2"	Cutting mat	5 / 7	●	●	-	●	P.37
	87434-G	680	5"X2"	Cutting mat	5 / 7	●	●	-	●	P.37
	87634	360	5"X1-1/4"	Cutting mat	7	●	-	●	-	P.38
	87G31	500	5"X2"	Steel	6 / 7	●	-	●	●	P.40
	87G38	400	5"X2"	PVC multil-f	6 / 7	●	-	-	-	P.39
	87SQ31	500	5"X2"	Stainless	6 / 7 / 8	●	●	●	●	N5
XL	87SQ32	700	5"X2"	Stainless	6 / 7 / 8	●	●	●	●	N6
	87SQ33	700	5"X2"	Stainless	6 / 7 / 8	●	●	●	●	N6
XXL	87435	600	6"X2"	Cutting mat	13	●	-	-	-	P.38
SV	87SQ34	700	5"X2"	Wooden	10	●	●	●	●	N8
	87441	540	4"X1-1/4"	Cutting mat	1 / 3	●	-	-	-	P.43
	87446	600	4"X1-1/4"	Cutting mat	3	●	-	-	-	P.44
	87G41	150	4"X1"	PVC multil-f	-	-	-	-	-	P.40



Customized Color Choice Chart



8743X-XB-B

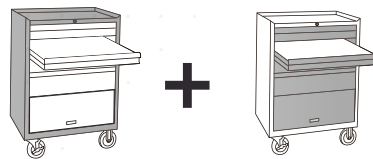

		-RK	
		-B	
		-BK	
		-K	
		-G	
		-OK	

(Other colors are optional, produce with minimum quantity)

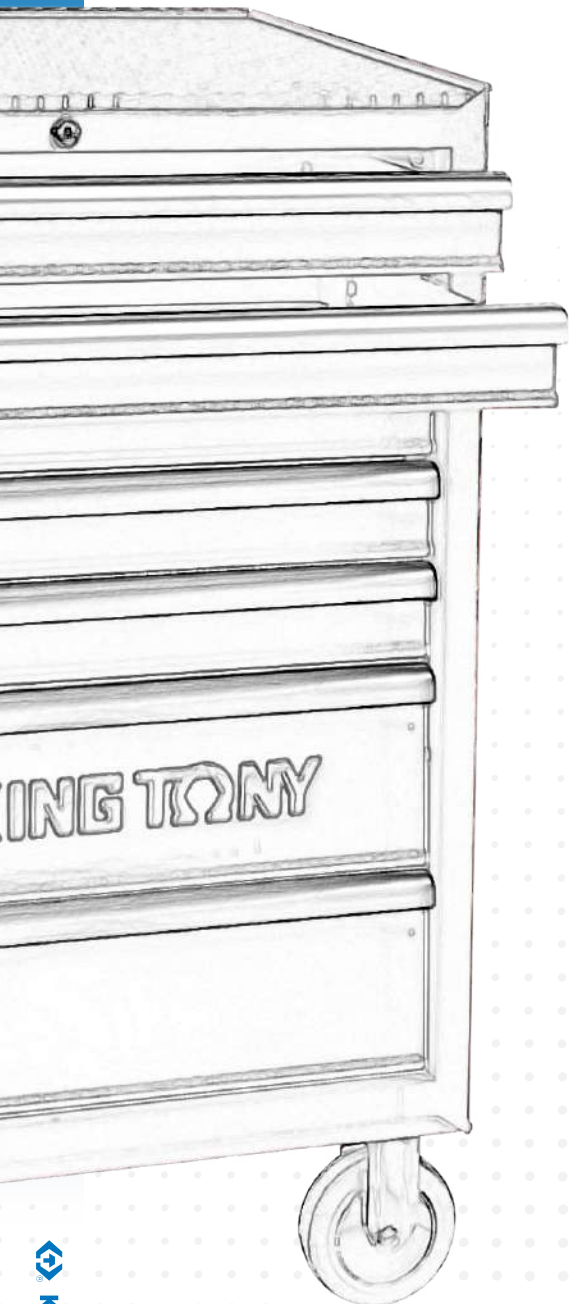

Load bearing



- Overall supporting weight for tool trolley at a safety level



- Overall supporting weight for drawers at a safety level

Convenient



- Convenient and safety with Central lock system



- 100% drawer opening, does not interfere with the removal of tools



- 360° swivel wheel with brake function



- The size of the drawer conforms to TCS, and the tool set can be purchased freely according to the demand

Robustness



- Body frame are constructed with one-piece steel sheet for integral strength



- The bottom of the drawers are stamped in order to strengthen effectively

Protection



- Protection bumpers are for to avoid collisions and to protect object during maneuver



- Risk Free System (RFS) allows open one drawer at a time which prevents the loss of center of gravity from tilting and instability



- Press to open drawer is a safe and reliable system

Features



• 100% open ball bearing slide for drawer



• Industrial TPR floor brake casters



• One piece steel body

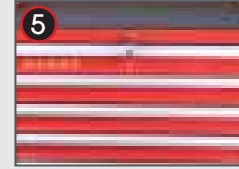

• Central locking system + 10mm top mat



• Embossed & hammed edge drawer increase strength



• Add strength and safety

Tool Trolley

(Other colors are optional, produce with minimum quantity)



87432-5B



87434-7B



87432-5G



87434-7G

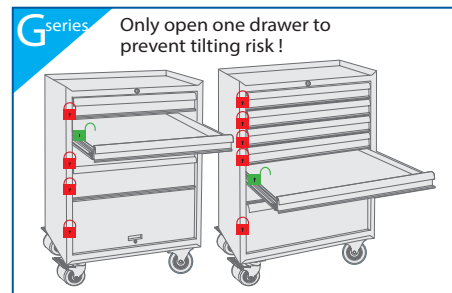
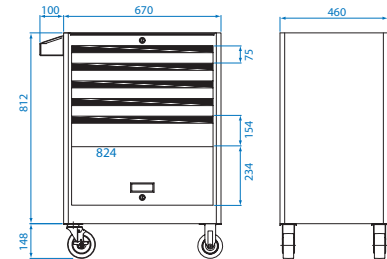

KT NO.	Spec.	Dimension(mm) Width x Depth x Height	Casters	Static load		CUFT
87432-5B	4 Drawer	576 x 380 x 75	5"x1-1/4"	360 Kg	56	12.24
	1 Drawer	576 x 380 x 154				
	Bulk Drawer	603 x 404 x 234				
87434-7B	5 Drawer	576 x 380 x 75	5" x 2"	680 Kg	56	
	2 Drawer	576 x 380 x 154				
87432-5G	4 Drawer	576 x 380 x 75	5" x 2"	680 Kg	56	
	1 Drawer	576 x 380 x 154				
87434-7G	Bulk Drawer	603 x 404 x 234	5" x 2"	680 Kg	64	
	5 Drawer	576 x 380 x 75				
	2 Drawer	576 x 380 x 154				

Classic Bumper Type Tool Trolley

87634-7B

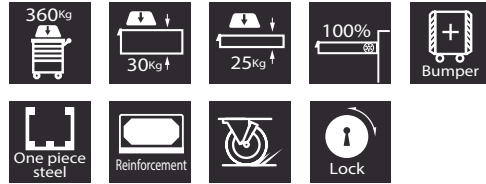

- Soft bumpers each side avoids scratch or damage vehicle
- More space for bottles & hanging
- Easily move two side handle bar & industrial TPR casters
- 100% pull out ball bearing drawer
- One piece steel for heavy load structure
- Central locking system + 10mm top mat

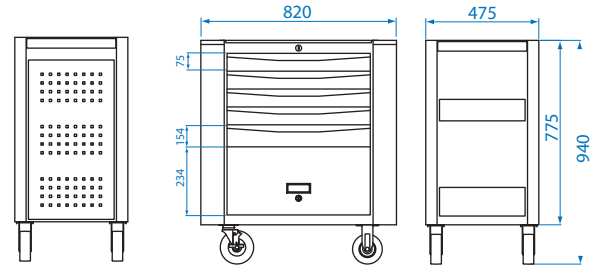

KT NO.	Spec.	Dimension(mm) Width x Depth x Height	Casters	Static load		CUFT
87634-7B	5 Drawer	576 x 380 x 75	5" x 1-1/4"	360 Kg	66.14	15.64
	2 Drawer	576 x 380 x 154				

Tool Trolley

87435-13B

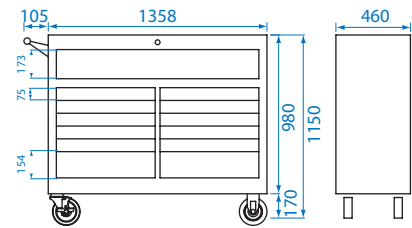
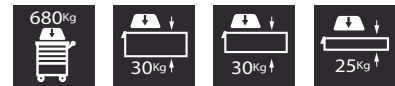

KT NO.	Spec.	Dimension(mm) Width x Depth x Height	Casters	Static load		CUFT
87435-13B	10 Drawer	576 x 380 x 75	6" x 2"	600 Kg	166	31.54
	2 Drawer	576 x 380 x 154				
	1 Drawer	1215 x 390 x 173				

Features



• Trash can hook



• Side compartment



• Industrial TPR floor swivel casters



• Multi-functional working top

Tool Trolley



- Magnetic drawer closures
- Multi-functional working top
- Side locking system

87G38-7B-K

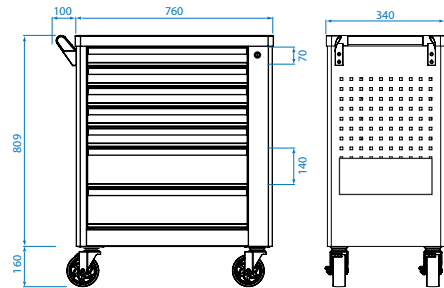

KT NO.	Spec.	Dimension(mm) Width x Depth x Height	Casters	Static load		CUFT
87G38-7B-K	Overall	752 x 450 x 807	5" x 2"	400 Kg	58	13.19
	Overall+4 Casters	752 x 450 x 982				
	5 Drawers 2 Drawers	570 x 380 x 70 570 x 380 x 140				





Features



• Side handle bar



• Flat side panel



• Top platform



• Industrial TPR floor brakes casters



• Garbage bin

Heavy Duty Tool Trolley & Chest



87G31-7B-BK

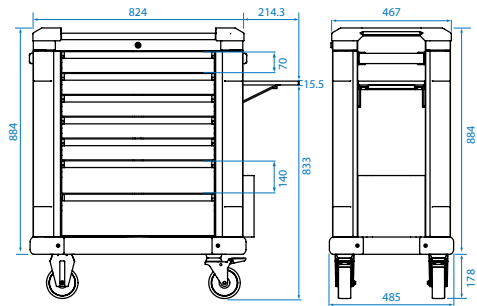

KT NO.	Spec.	Dimension(mm) Width x Depth x Height	Casters	Static load		CUFT
87G31-7B-BK	Overall	824 x 485 x 884	5" x 2"	500 Kg	75.00	16.85
	Overall + 4 Casters	824 x 485 x 1062				
	5 Drawers	575 x 410 x 70				
	1 Drawers	575 x 410 x 110				
	1 Drawers	575 x 410 x 140				

Heavy Duty Tool Trolley & Chest

| 87G11-4B-BK

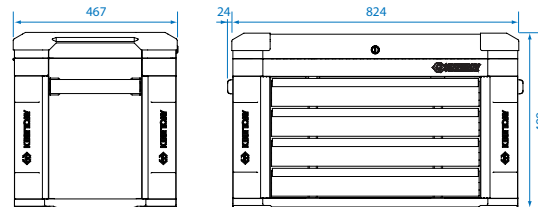

KT NO.	Spec.	Dimension(mm) Width x Depth x Height		Kg	CUFT
		Overall	4 Drawers		
87G11-4B-BK	Overall	824 x 467 x 499		41.5	9.72
	4 Drawers	575 x 410 x 70			

| 87G001DQ-BK (include 87G11-4B-BK + 87G31-7B-BK)



- 4 drawers top chest + 7 drawers tool trolley
- ABS corner protection bumpers avoids damaging vehicle
- 100% pull out ball bearing drawer with auto-return system
- Heavy duty ball bearing sides, 35kgs capacity for each drawer
- Top chest lid with hydraulic bars
- With side tray and garbage bin
- Internally welded joints for durability

KT NO.	Spec.	Dimension(mm) Width x Depth x Height		Casters	Static load	Kg	CUFT
		Overall	Overall +4 Casters				
87G001DQ-BK	Overall	843 x 467 x 1365		5" x 2"	630 Kg	124.00	27.25
	Overall +4 Casters	843 x 467 x 1543					





Accessory

87432-15

- Plastic top mat
- Size : 920(W) x 490(D) x 50(H)mm



84087637BKT

- Plastic mat
- Size : 665(W) x 455(H) x 19(D) mm



87432-31

- Side handle bar
- Size : (Ø)38.5 x 457(L) mm



87432-32

- Can holder



87432-52

- Paper holder
- Size(H x L x D) : 45 x 290 x 65 mm



87432-17

- Flat side panel
- Size : 456 x 370mm



87432-23

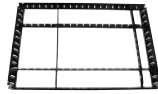

87432-24



KT NO.	Frame(mm) Width x Depth x Height	Material	Divider Size mm
87432-23	574 x 358 x 40	Steel	Long: 560x40(2PC.) Short: 368x40(2PC.)
87432-24	-	Plastic	Long: 570x40(3PC.) Short: 375x40(3PC.)

87432-33

- Magnetic tool holder
- Size : 458 x 52 x 17mm



87432-34

- Bottle side holder



87432-41

- Work panel
- Size : 656(W) x 500(H) x 30(D) mm



Can't install side tray(87432-32) at the same time



Tool Trolley



87441-1B

- 1 drawer trolley
- Two 3.5" deep trays are positioned for convenience



87441-3B

- 3 drawer trolley
- 2 PC. protective mat for top and bottom shelves
- 3 PC. protective drawer liners

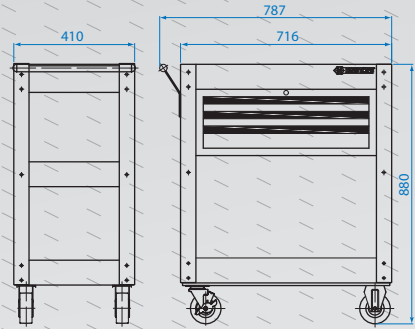

87G41-B

- With multi-functional working top
- 4" x 1" Heavy duty casters (2 Fixed and 2 swivel with stop function)

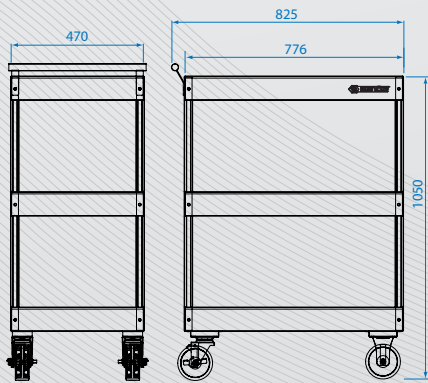

KT NO.	Spec.	Dimension(mm) Width x Depth x Height	Casters	Static load		CUFT
87441-1B	overall	716 x 410 x 750	4" x 1-1/4"	540 Kg	23.2	2.7
	overall + 4" x 1-1/4" Casters	716 x 410 x 880				
	1 Drawer	569 x 275 x 75				
87441-3B	overall	716 x 410 x 750	4" x 1-1/4"	540 Kg	33.0	4.95
	overall + 4" x 1-1/4" Casters	716 x 410 x 880				
	1 Drawer	569 x 275 x 75				
87G41-B	Overall	776 x 470 x 900	4" x 1"	150 Kg	23.0	3.67
	Overall + 4 Casters	776 x 470 x 1050				





Tool Trolley

- 3 drawer trolley
- 2 PC. protective mat for top and bottom shelves
- 3 PC. protective drawer liners

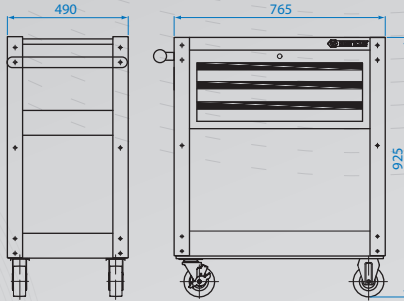









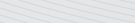

▪ Multiple space bar to hold other tools



KT NO.	Spec.	Dimension(mm) Width x Depth x Height	Casters	Static load		CUFT
87446-3B-KR	overall	765 x 490 x 760	5"x1-1/4"	600 Kg	38	13
	overall + 5"x1-1/4" Casters	765 x 490 x 925				
87446-3B-KB	3 Drawer	576 x 380 x 75				

Accessory

KT NO.	Contents
87502-01	 Tool holder 500mmL
87502-02	 Magnetic tool holder for workbench backpanel Size : 458 x 52 x 17mm
87502-050	 U Shape hook
87502-051	 1" Shape hook
87502-054	 4" Shape hook
87502-058	 8" Shape hook
87502-061	 1" Double hook
87502-064	 4" Double hook
87502-068	 8" Double hook
87502-11	 <ul style="list-style-type: none"> ▪ Cutting board ▪ Oil-resistant, acid-resistant, moisture-resistant and anti-static ▪ 10mm PP foaming board
87502-12	 <ul style="list-style-type: none"> ▪ 4 PC. Adjusting device ▪ Includes adjustable bolt & adjustable pad



Roller Seat

Material: PVC leather + foam cushion + finishing powder coating steel
Two Open Storage Areas



▪ Four 360° swivel Casters



Metal tray with rack function



Metal tray

KT NO.	Dimension(mm) Width x Depth x Height	Kg		CUFT	
		Weight	Volume	Weight	Volume
87452B-B	350 x 260 x 240	6.4	1 / 1	0.49	
87452C-B		6.3	1 / 1		

87C34-3B-B

- Material : PVC leather + foam cushion + finishing powder coating steel
- 3 ball bearing drawers : 274 x 148 x 35 mm
- 3 bottle side holder



▪ Four 360° rotation 3"x1" casters

KT NO.	Dimension(mm) Width x Depth x Height	Kg		CUFT	
		Weight	Volume	Weight	Volume
87C34-3B-B	370 x 400 x 365	8.8	1	2.43	



Workbench

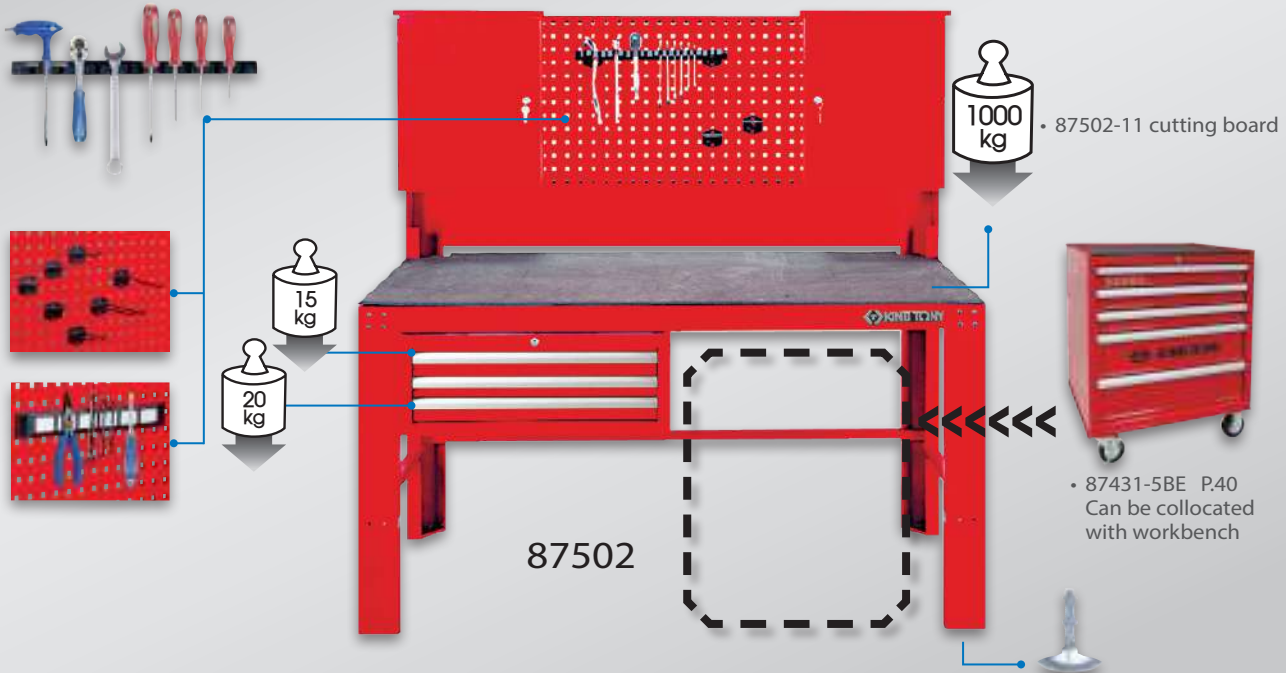

87431-5BE

- Four swivel casters(one is with brake mechanism)

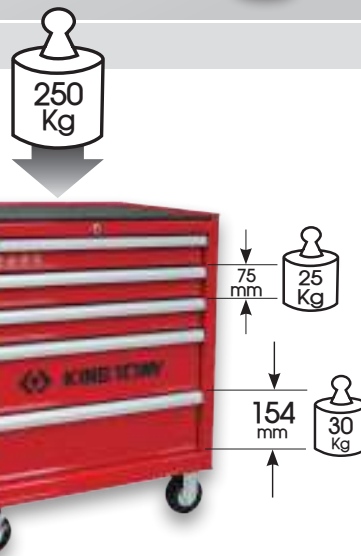
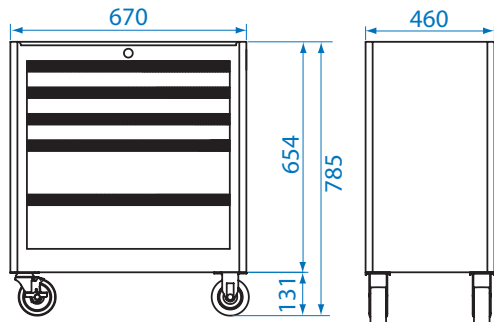

KT NO.	Spec.	Dimension(mm) Width x Depth x Height	Casters	Static load		CUFT
87431-5BE	3 Drawer	576 x 380 x 75	4" x 1-1/4"	250 Kg	50	10.03
	2 Drawer	576 x 380 x 154				

87502P02

- Drawer chest for workbench



KT NO.	Spec.	Dimension(mm) Width x Depth x Height		CUFT
87502P02	Overall	660 x 307 x 251	13.00	2.7
	2 Drawer	569 x 275 x 50		
	1 Drawer	569 x 275 x 75		

87502P03





- 2 PC. wall cabinets

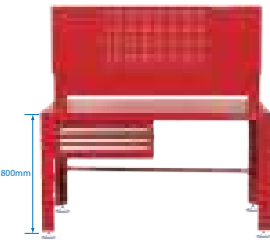

KT NO.	Spec.	Dimension(mm) Width x Depth x Height		CUFT
87502P03	Overall	400 x 200 x 500	14.00	4.5

Workbench

• Workbench excludes cutting board & tool holder

KT NO.		Spec.	Dimension(mm) Width x Depth x Height	Kg	CUFT	
87502		<ul style="list-style-type: none"> 3 drawer chest-ball bearing slide 2 wall cabinets 	Overall	1525 x 700 x 1520	86.00	13.4
			3 Drawer chest	660 x 307 x 251		
			2 Drawer	569 x 275 x 50		
			1 Drawer	569 x 275 x 75		
			Wall cabinet	400 x 200 x 500		
87502P01		<ul style="list-style-type: none"> Workbench with back panel 	Overall	1525 x 700 x 1520	59.00	6.5
87502P011		<ul style="list-style-type: none"> Workbench 	Overall	1525 x 700 x 800	48.00	6.5
87502P012		<ul style="list-style-type: none"> Back panel 	Overall	1525 x 20 x 700	13.50	2.7

87512

KT NO.		Spec.	Dimension(mm) Width x Depth x Height	Kg	CUFT	
87512		<ul style="list-style-type: none"> 3 drawer chest ball bearing slide 1 wall cabinet 	Overall	1565 x 766 x 1403	130.10	21.19
			3 Drawer chest	668 x 313 x 270		
			2 Drawer	568 x 262 x 50		
			1 Drawer	568 x 262 x 75		
			Wall cabinet	1565 x 203 x 603		

Wall Mounted Type Tool Cabinet

87201

- With 20 PC. hooks
 - 5 PC. U shape hook (87502-050)
 - 10 PC. 1" single hook (87502-051)
 - 5 PC. 1" double hook (87502-061)
- Heavy duty design for storage heavy duty tool
- Powder coating finishing
- Full opened door with 2 aluminum alloy handles
- 4 holes on the back of cabinet to be fixed on the wall
- Double wall door panel design, peg hole at inside wall of door



Steel thickness: (body) 1.0 mm



87502-050 87502-051 87502-061

KT NO.	Spec.	Dimension(mm) Width x Depth x Height	Kg	CUFT
87201	Overall	820 x 250 x 900	24.00	8



Tool Chest



87411-6B



87411-9B



87419-5B
(Extra deep)



87417-10B
(Extra deep)

- Powder coating
- Ball bearing slide
- Central locking system
- Hemmed edge design to improve strength and safety
- Drawer quick release and detent design

Selective colors:



(Produce with minimum quantity)

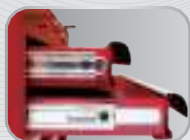

• Ball bearing slides

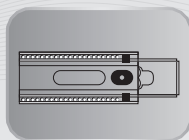

• Steel ball



• Lockable



• Plastic drawer divider for cabinet

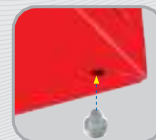

• Bottom rubber mats to avoid slipping

KT NO.	Spec.	Dimension(mm)		Kg	CUFT
		Width x Depth x Height			
87411-6B	Overall	660 x 307 x 374		25.40	3.97
	Top	646 x 290 x 60			
	3 Drawer	170 x 275 x 50			
	2 Drawer	569 x 275 x 50			
	1 Drawer	569 x 275 x 75			
87411-9B	Overall	660 x 307 x 427		30.20	4.3
	Top	646 x 290 x 60			
	6 Drawer	170 x 275 x 50			
	2 Drawer	569 x 275 x 50			
	1 Drawer	569 x 275 x 75			

KT NO.	Spec.	Dimension(mm)		Kg	CUFT
		Width x Depth x Height			
87419-5B	Overall	660 x 455 x 483		40.00	8.58
	Top	646 x 420 x 70			
	2 Drawer	576 x 410 x 48.5			
	3 Drawer	576 x 410 x 75			
87417-10B	Overall	660 x 455 x 483		51.20	8.58
	Top	646 x 420 x 70			
	6 Drawer	169 x 410 x 48.5			
	1 Drawer	169 x 410 x 154			
	2 Drawer	576 x 410 x 48.5			
	1 Drawer	576 x 410 x 75			



87421-3B



87422-3B (Extra deep)

- 3 drawer chest
- Intermediate type
- Heavy gauge steel
- Drawer slides type-ball bearing
- Grooved full width drawer pulls add strength and offer to list contents of drawer
- Central locking system
- 10mm Top mat
- Powder coating finish
- 4 pins on the middle chest corners to tie in with top chest for extra security
- Overall size (mm) - 660(W) x 307(D) x 251(H) for 87421-3B
Overall size (mm) - 660(W) x 455(D) x 254(H) for 87422-3B

KT NO.	Spec.	Dimension(mm) Width x Depth x Height	Kg	
			kg	CUFT
87421-3B	Overall	660 x 307 x 251	13.00	2.7
	2 Drawer	569 x 275 x 50		
	1 Drawer	569 x 275 x 75		
87422-3B	Overall	660 x 455 x 254	24.8	5
	2 Drawer	576 x 410 x 48.5		
	1 Drawer	576 x 410 x 75		

Selective colors:



(Produce with minimum quantity)

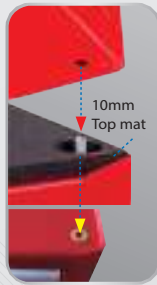

10mm
Top mat



• Ball bearing slides



• Steel ball



- Heavy gauge steel plus flange reinforced design
- Close cover synchronously lock all of the drawers
- Powder coating
- Overall size (mm) - 535(W) x 220(D) x 287(H)

KT NO.	Spec.	Dimension(mm) Width x Depth x Height	Kg	CUFT
87401-2	2 Drawer	504 x 195 x 79	8.80	2.05
87401-3	3 Drawer	504 x 195 x 52	10.20	
87401-3H	3 Drawer	504 x 195 x 52	11.20	



87401-2



87401-3



87401-3H

Only 87401-3H:



• Internal lock system



• Ball bearing slides

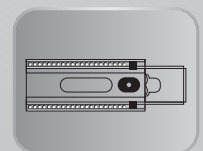

• Steel ball



Tool Box

87402

- 3 section fold up type and adjustable
- Tubular handle, curved hinge
- Shaped pressing on flat surface to reinforced steel strength

KT NO.	Spec.	Dimension(mm) Width x Depth x Height	Kg	CUFT
87402	5	470 x 220 x 260	5.60	1.22
87408	compartments	530 x 220 x 260	6.70	1.3

87A05

- 3 section fold up type and adjustable
- Tubular handle, curved hinge
- Shaped pressing on flat surface to reinforced steel strength

KT NO.	Spec.	Dimension(mm) W x D x H	Kg	CUFT
87A05	5 compartments	470 x 220 x 260	5.10	1.41
87A05-KB		530 x 220 x 260	6.80	1.48
87A051				
87A051-KB				

87408



87A051



87A051-KB



87A05



87A05-KB

87A08

- Material : PP + Metal
- Shock-resistant reinforced polypropylene shell with metal cover
- Impact resistant and sturdy bumper at corners
- 30kgs load on top and stackable design
- V groove on top for sawing or placement
- Easy to use with grip handle for carry
- Portable tote tray take tools or small parts
- Lockable allow use padlock for security
- Metal double clasp

KT NO.	Spec.	Dimension(mm) Width x Depth x Height	Kg	CUFT
87A08	2 compartments	470 x 210 x 207	2.0	0.91



87404

- Material : PP
- Multi-function box, extra space for tools and parts
- Lightweight
- Durable design for tool storage

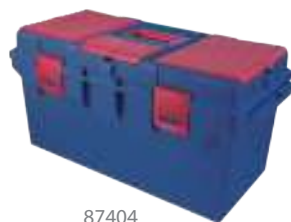

87404

87407



87407

KT NO.	Spec.	Dimension(mm) Width x Depth x Height	Kg	CUFT
87404	2	560 x 278 x 270	2.40	1.75
87407	compartments	445 x 240 x 206	1.74	0.79



Parts Box

87137

- Parts box
- Material : PP

KT NO.	Dimension(mm) Width x Depth x Height		
	180 x 39 x 96	109	
87137	180 x 39 x 96	109	



• PP plastic storage box for spare parts

Portable Storage Box

8714101B

- Adjustable compartment is suitable for arranging different size of parts and accessories
- Transparent cover make it easy to find the parts you need
- The box is stackable design, you can combine two boxes together easily
- Durable material, easy to carry



- Adjustable compartment
- Suitable for arranging parts & accessories
- Stackable design
- Slide to lock

KT NO.	Size mm		
8714101B	376 x 290 x 67	790	1 / 16



Fabric Tool Bag

87711C

- Waterproof 600D Oxford
- Lightweight stainless bar & comfortable EVA handle
- Velcro cover for easy access & quickly take out tools
- Adjustable ambi-bag with soft padded shoulder strap

- 39 inner pockets for multiple-tools storage
- 50% less weight than metal box

KT NO.	Dimension(mm) Width x Depth x Height			
	510 x 255 x 345	3.00		
87711C	510 x 255 x 345	3.00	1 / 1	



87721B

- Heavy duty 600D Oxford
- Wide opening at top with zipper for easy access and security
- Removable shoulder strap
- Removable compartment for greater organization
- External and internal side pockets

KT NO.	Dimension(mm) Width x Depth x Height			
	360 x 200 x 260	0.95		
87721B	360 x 200 x 260	0.95	1 / 1	





Fabric Tool Bag

87722B

- Waterproof, reinforced rubber base protects tools
- 600D Oxford
- Internal and external storage pockets
- Zip fastening and rubber comfort grip handles
- Removable padded shoulder strap for comfortable carry

KT NO.	Dimension(mm)			
	Width x Depth x Height			
87722B	380 x 230 x 350	1.80	1 / 5	





87732D

- For travelling, gyms
- Shoe compartment with a waterproof material
- Multi-layered and able to carry all types of protective gear
- Durable hard bumpers on base corners
- Inner flat zippered mesh pocket on flap and main compartment separation

CONSTRUCTION :

- 2 ventilation holes on the side
- 2 big webbing handle on top and the side to be able to move and carry the bag
- 2 strap handles to lift up the bag and carry on the shoulder
- 2 mesh pockets on internal sides of the bag
- 2 small front pockets
- 2 side pockets with zippers

KT NO.	Dimension(mm)			
	Width x Depth x Height			
87732D	500 x 260 x 210	1.00	20	



87724D



- External and internal side pockets
- Removable shoulder strap
- 600D Nylon Oxford

KT NO.	Dimension(mm)			
	Width x Depth x Height			
87724D	330 x 125 x 250	0.52	20	



87733D

- Durable fabric, smooth zipper and soft padding back
- Comfortable and Long-Lasting Usage
- Adjustable Waist Belt max to 130cm
- With 3 zippered pockets
- Convenient Earphone Hole
- Glow-in-the-dark logo keep you safe in the dark

KT NO.	Dimension(mm)			
	Width x Depth x Height			
87733D	420 x 120 x 150	0.19	50	



Multi-use Backpack

87731D

- Multi-layered, easy to organize
- Extra side pocket



• External USB charge port design





• The breathable and comfortable shoulder straps foam is added inside



KT NO.	Dimension(mm) Width x Depth x Height		
87731D	310 x 150 x 440	0.6	40

87723B

- Material: 600D polyester
- Max Load: 20 kg
- Includes 14 pockets
- A water-proof and wear-resistant PVC base
- The main bag has a large capacity for easy access to tools. Multiple pockets can hold various tools within the backpack

KT NO.	Dimension(mm) Width x Depth x Height		
87723B	350 x 210 x 490	1.75	4



• The pads on the back of the product can absorb vibrations and increase breathability, making it more comfortable to carry





Modular Stacking Box

Modular Stacking Box

According to the demand of tools in different working environments, we've designed toolboxes to cope with different working situations. It is more convenient for the out-of-home technician to carry the tools, also reducing the time for the technician to go back and forth between the vehicle and the construction site.

This saves the technician's time and energy, improving the technician's work efficiency and mobility



- For better clarity you can attach labels to either the front or the sides of the case to optimize your workflow



- Fixing boxes in pallet truck

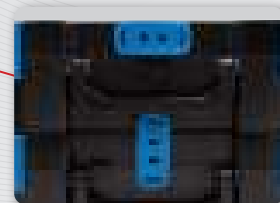

- I-Locking the 90° twist system is also extremely practical since you can open it just using one hand



- With four swivel casters of which two are braked by an integrated brake



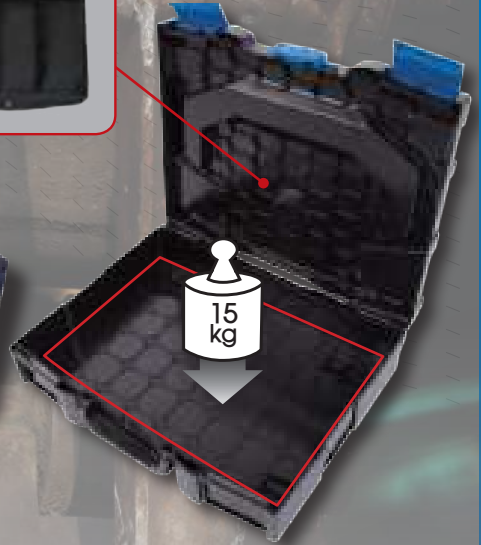

•The sturdy and ergonomic handles on the lid and in the front can be easily carried according to your requirement

• The double-layer tool pouch can adjust the space through the buckle to facilitate the user take the tools



87405-3
456 x 372 x 262 mm



87405-2
456 x 372 x 155 mm



87405-1
456 x 372 x 115 mm



87405-9
655 x 490 x 170 mm



Tool Box Set

37
PC.



9052-001MRV

Plastic case size (mm) :
456 x 372 x 155 (0.93 cuft)

TOOLS STORAGE & TOOLS SYSTEM SETS



Pouch 1

6
PC.

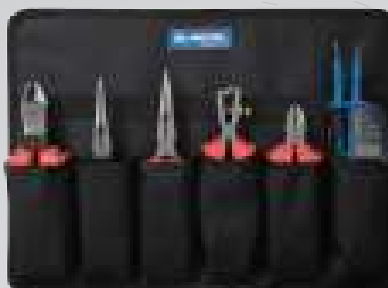

Pouch 2

21
PC.



EVA foam(9-90110GPV)

10
PC.



Pouch 1

Contents

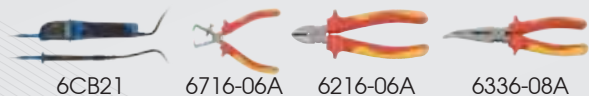

6CB21

6716-06A

6216-06A

6336-08A



6318-08A

6146-08A

Pouch 2

Contents

⊕ 1471 PH0 x 75, PH1 x 100, PH2 x 100

⊖ 1472 3 x 75, 4 x 100, 5.5 x 125, 6.5 X 150

⊗ 1120MR H1.5, H2, H2.5, H3, H4, H5, H6, H8, H10

20002UB 5 x 6mm, 8 x 10mm



6CB02

3611VE-08

79095-05M

EVA foam(9-90110GPV)

Contents



8.69

CUFT 1.16



6511-10

3611-10R

76223-08

76210-10

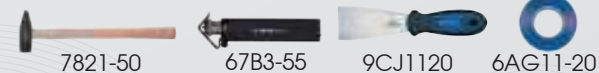

7821-50

67B3-55

9CJ1120

6AG11-20



6311-08

67A1-07

Tool Box Set

112
PC.



9052-002MRV

Plastic case size (mm) :
456 x 372 x 155 (0.93 cuft)



Pouch 1

13
PC.



Pouch 2

7
PC.





EVA foam(9-7592MPV)

92
PC.

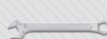

Pouch 1

Contents

	1062	8, 9, 10, 11, 12, 13, 14, 16, 17, 18, 19, 22
	9TA281	

Pouch 2

Contents













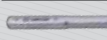
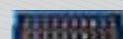

			
3611-10R	6AB31-75	6211-06	6111-07
			
6311-08	6511-10	79095-05M	

EVA foam(9-7592MPV)

Contents



10.46 KG CUFT 1.16

	2335MR	4, 4.5, 5, 5.5, 6, 7, 8, 9, 10, 11, 12, 13, 14
	4335MR	10, 13, 15, 16, 17, 18, 19, 20, 21, 22, 24, 27, 30, 32
	1147PR	T10H, T15H, T20H, T25H, T27H, T30H, T40H, T45H, T50H
	1120MR	H1.5, H2, H2.5, H3, H4, H5, H6, H8, H10
	20002UB	5 x 6mm, 8 x 10mm
	1032CQ	
	1005APR	
	2792	
	4791R	
	4251-10R	
	2179DF	
	7821-30	
	4773-10GS	
	2755-55G	
	2142	





Handy case

Handy Case Series

The outside of handy case can afford high load capacity, and great crash-resistance. There are four different sizes with the conception of T.C.S mod. Therefore, its design is based on the user perspective, easy to carry and store, make every user enjoying their work.

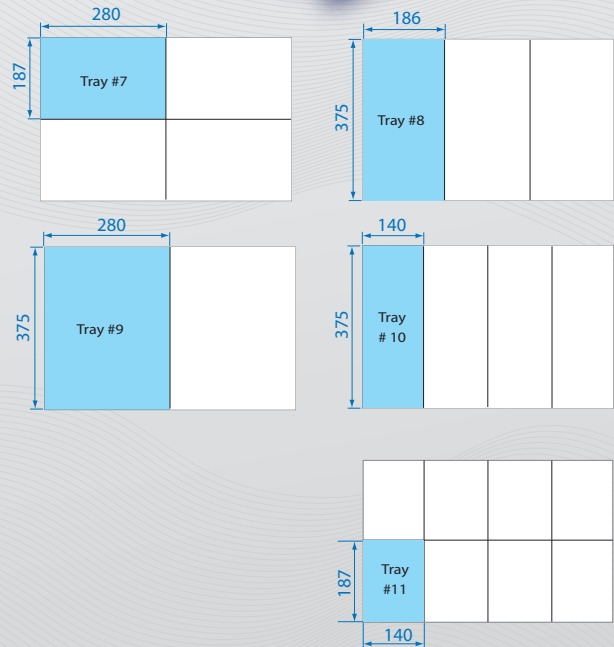
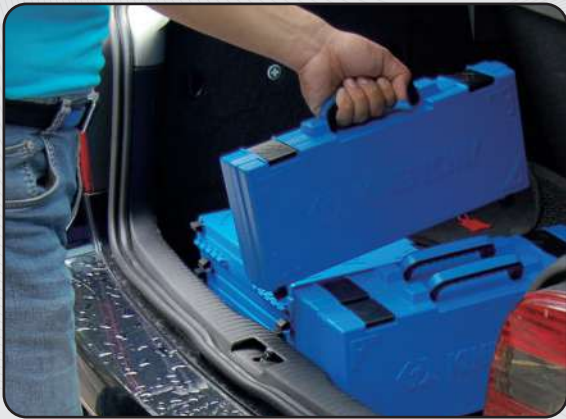

Handy Case

820011

- Made of shockproof PE-HD for heavy duty contents
- Ideal for tool storage & tool box system
- Easy to pile and store
- Anti-collision
- Case for Eva foam / tray



• Steel buckle provides security & strength

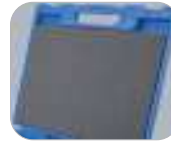

• Foam protection against collisions



• Hexagon overlap in 4 corners, easy to file up



• Extra space for thumb taking out

KT NO.	Size mm	EVA / Tray		
820011	422 x 372 x 92	#9	1417	1 / 4

82000

- Tool case made of sturdy ABS material
- Ideal for tool storage & tool box system
- Easy to pile and store
- Case for Eva foam / tray



• Plastic padding for better stable storage
• The hinge construction makes box more durable



• 180° swivel handle easy to carry



• Easy and quick to lock



• Foam protection against collisions



• Hexagon overlap in 4 corners, easy to pile up



• Extra space for thumb taking out

KT NO.	Size mm	EVA / Tray		
820001	294 x 231 x 66	# 7	641	1 / 6
820002	389 x 184 x 66	#10	651	1 / 5
820003	389 x 229 x 66	# 8	793	1 / 4
820005	199 x 171 x 50	#11	293	1 / 8

Multi-Storage Case

827011

- Heavy duty plastic blow case with foam padded internal
- High impact polystyrene with dividers make 12 spaces
- Easy to carry tools from trolley & store bolts, nuts
- Mini case (278 x 87 x 42 mm)



Blow case size (mm) :
422 x 372 x 92 (0.51 Cuft)

KT NO.	Contents		
827011	84700011B x4	2.19	1 / 4

Plastic Tray

847000

- For accessories, parts and consumables
- Easily combine the parts box sizes depending on the handy case
- Easy to carry and segment

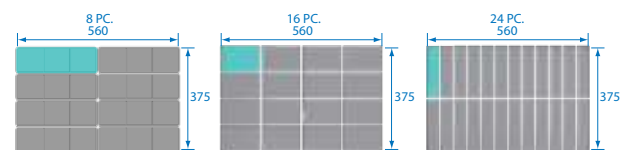

KT NO.	Size		
84700011B	283 x 93 x 43	150	8 / 72
84700002B	140 x 93 x 43	75	16 / 144
84700003B	187 x 47 x 43	50	24 / 216



Tools Control & Security Storage System

How to complete your tool trolley set and tool chest set

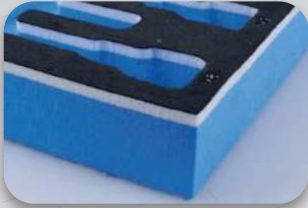

Three-colors fabrication



waterproof



Laser marking



Missing tools detected

Drawer (646x290 mm)

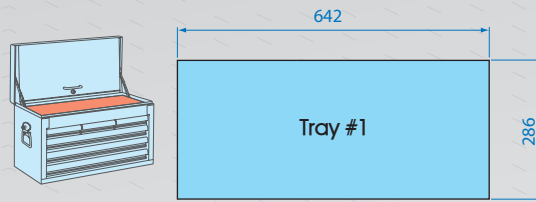

Drawer (172x275 mm)

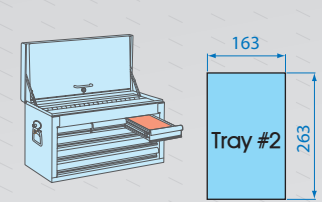

Drawer (572x275 mm)

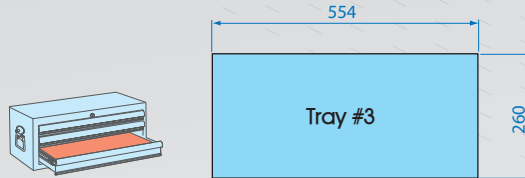

Drawer (579x380 mm)

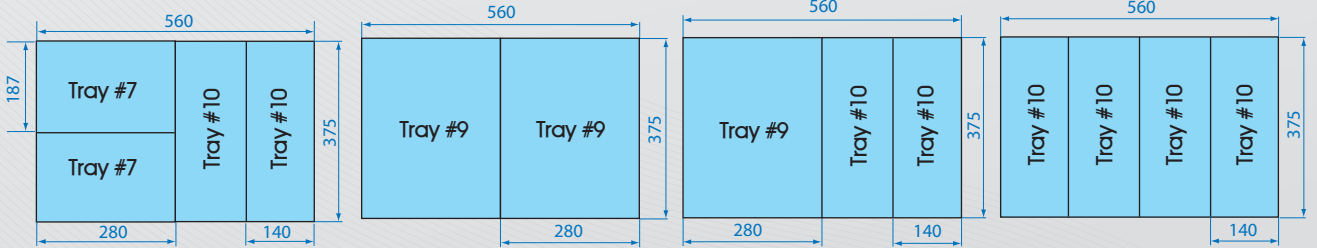
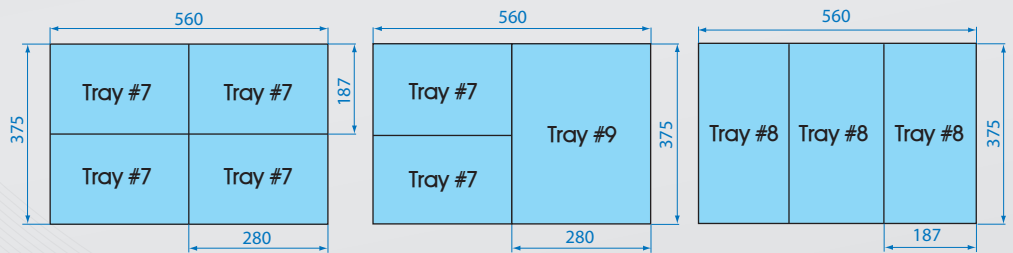
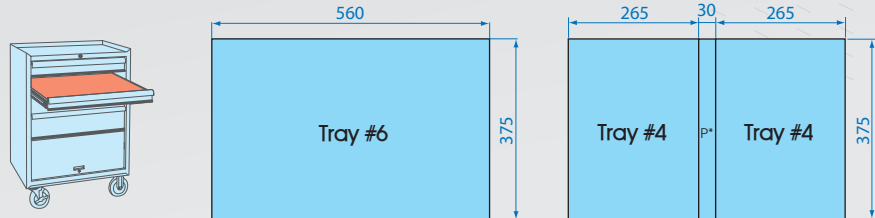

Drawer (896 x 379 mm)

▪ for 87462-7G-KB

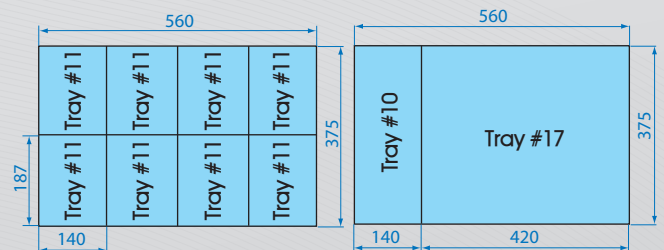
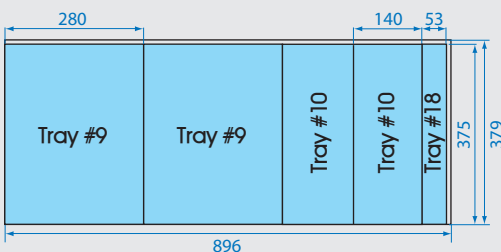
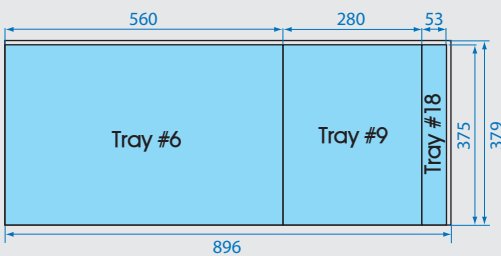

▪ Security:

Separate spaces for each tools to prevent them being left in dangerous areas

▪ Benefit:

Tools are quickly located and immediately returned after use to avoid loss

3 colors EVA foam offers convenient identification of use with sustained sizes and mark

▪ Efficiency:

A quick glance helps for missing tools

Durable material prevents being dirty for easy maintenance





Tool Trolley Contents

235
PC.



Contents No. 934-235MRVD

24.15 2.62

- Special tool set for Automobile, suitable for VOLKSWAGEN-GROUP, MERCEDES-BENZ, OPEL, BMW & Japanese passenger car



9-4537MRV #9 P.80

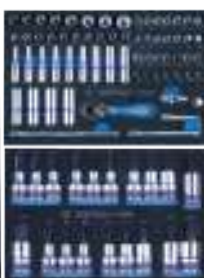

9-2565MRV #7 P.76
9-4129PRV #7 P.76



9-4147PRV #10 P.88



9-90135MRV #10 P.88



9-1220MRV #9 P.81

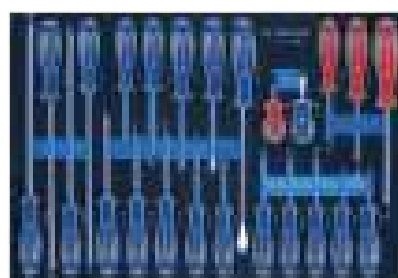

9-31124MRV #6 P.75



9-90119MRV #9 P.82



9-40104GPV #10 P.88



9-40113GPV #10 P.88



9-44214GPV #10 P.88



9-90118PRV #10 P.89



Tool Trolley Set

235
PC.



88.15
CUFT 14.86



934-235MRV
(87434-7B P.37)



934-235MRV-G
(87434-7B-G P.37)



934-235MRV-B
(87434-7B-B P.37)



90.29
CUFT 18.26



9634-235MRV
(87634-7B P.38)



9634-235MRV-G
(87634-7B-G P.38)



9634-235MRV-B
(87634-7B-B P.38)



Tool Trolley Contents

286 PC.



Contents No. 934-010MRVD 28.1 CUFT 2.51

- Special tool set for automobile, suitable for VOLKSWAGEN-GROUP, MERCEDES-BENZ, OPEL, BMW & Japanese passenger car



9-3544MRV #9 P.79



9-4537MRV #9 P.80



9-4147PRV #10 P.88



9-4401MPV #10 P.88



9-2565MRV #7 P.76
9-4129PRV #7 P.76



9-90119MRV #9 P.82



9-1220MRV #9 P.81

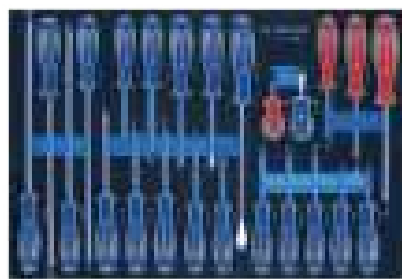

9-31124MRV #6 P.75



9-40104GPV #10 P.88



9-40113GPV #10 P.88



9-90135MRV #10 P.88



9-90118PRV #10 P.89



Tool Trolley Set

286 PC.



92.10
CUFT 15.03



934-010MRV
(87434-7B P.37)



934-010MRV-G
(87434-7B-G P.37)



934-010MRV-B
(87434-7B-B P.37)



94.24
CUFT 18.43



9634-010MRV
(87634-7B P.38)



9634-010MRV-G
(87634-7B-G P.38)



9634-010MRV-B
(87634-7B-B P.38)



Tool Trolley Contents

325 PC.



Contents No. 934-011MRVD

33.14 CUFT 3.75



9-3544MRV #9 P.79 | 9-4537MRV #9 P.80

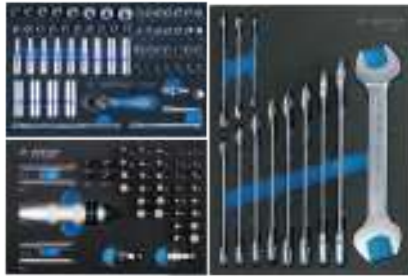

9-2565MRV #7 P.76 | 9-1112MRV #9 P.82
9-4143FRV #7 P.77



9-90119MRV #9 P.82 | 9-1220MRV #9 P.81

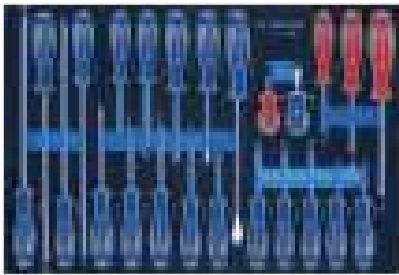

9-31124MRV #6 P.75



9-40104GPV #10 P.88 | 9-40113GPV #10 P.88
9-90135MRV #10 P.88 | 9-90118PRV #10 P.89



9-90413TQV #6 P.75



7962-04 P.478

9DC23 P.597

2121-18 P.605

7963-04 P.478

14210212 P.376
14226512 P.376

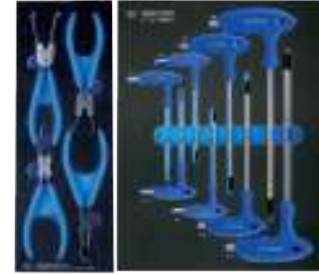

9-44214GPV #10 P.88 | 9-22108MRV #9 P.83



Tool Trolley Set

325 PC.

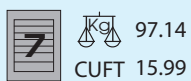

97.14 CUFT 15.99



934-011MRV
(87434-7B P.37)



934-011MRV-G
(87434-7B-G P.37)



934-011MRV-B
(87434-7B-B P.37)



99.28 CUFT 19.39



9634-011MRV
(87634-7B P.38)



9634-011MRV-G
(87634-7B-G P.38)



9634-011MRV-B
(87634-7B-B P.38)



Tool Trolley Contents

327 PC.



Contents No. 934-019MRVD Kg 56.68 CUFT 4.6



9-9003MRV01 #6 P.72



9-6314MRV #6 P.72



9-99430MFV #6 P.72



9-30208MRV #9 P.83



9-1220MRV #9 P.81



9-42116GPV #9 P.82



9-6414MPV #9 P.81



9-40104GPV #10 P.88



9-40113GPV #10 P.88



9-4147PRV #10 P.88



9-90118PRV #10 P.89



9-10112MRV #7 P.77
9-4143FRV #7 P.77



9-1044CQV #10 P.89
9-21-20-07MRV #10 P.89



Tool Trolley Set

327 PC.



Kg 120.68
CUFT 16.84



934-019MRV
(87434-7B P.37)



934-019MRV-G
(87434-7B-G P.37)



934-019MRV-B
(87434-7B-B P.37)



Kg 122.82
CUFT 20.24



9634-019MRV
(87634-7B P.38)



9634-019MRV-G
(87634-7B-G P.38)



9634-019MRV-B
(87634-7B-B P.38)



Tool Trolley Contents

525 PC.



Contents No. 935-525CRVD

68.08 CUFT 6.51



9-9003MRV01 #6 P.72

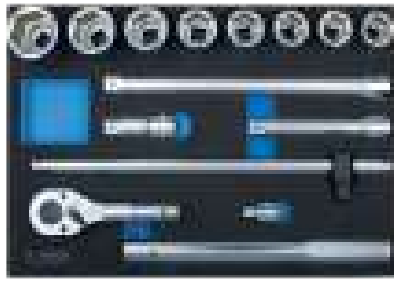

9-6314MRV #6 P.72



9-9040SRV #9 P.80



9-4129PRV #7 P.76
9-3612MR #7 P.127



9-4147PRV #10 P.88
9-4401MPV #10 P.88



9-4435MP #9 P.129



9-1112MRV #9 P.82



9-1220MRV #9 P.81



9-90119MRV #9 P.82



9-91190CRV #9 P.83



9-91124MRV #6 P.75



9-90217GRV #6 P.74

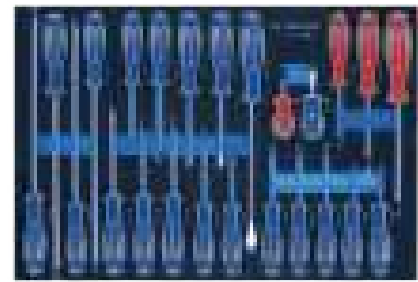

9-31124MRV #6 P.75



9-22108MRV #9 P.83



9-4143FRV #7 P.77
9-30904AY #7 P.127



9-90413TQV #6 P.75



74010 P.493

74020 P.493

74060 P.493

7861-16 P.470

7811-12 P.470

7851-16 P.471

7911-12 P.494

21-20-101 P.481

6532-14 P.370



79094-08C P.482



Tool Trolley Set

525 PC.



234.08
CUFT 38.05

935-525CRV
(87435-13B P.38)

Tool Chest Set

187
PC.



911-004CRV

47.38 CUFT 6.51



9-9077CRV #1 P.69



9-42102GPV #2 P.70

9-40122GPV #2 P.70

9-40112GPV #2 P.70



9-91131MRV #3 P.71



9-91126SRV #3 P.71

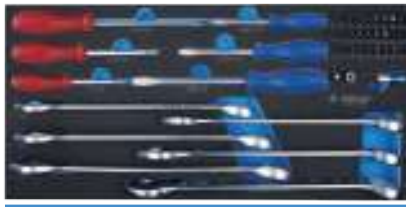

9-90145CRV #3 P.71

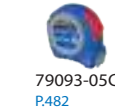

79093-05C P.482

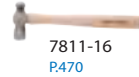

7811-16 P.470



87411-6B P.48

Tool Chest Set

219
PC.



911-000CRV

48.27 CUFT 6.10



9-7069CRV #1 P.69



9-42114GPV #2 P.70

9-40102GPV #2 P.70

9-2548CRV #2 P.70

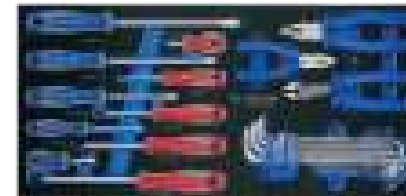

9-90129CRV #3 P.71



9-90128SR #3 P.111

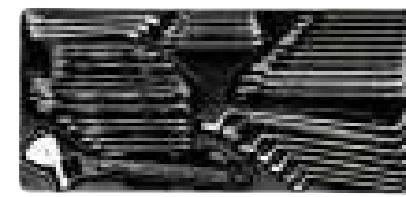

9-90138CR #3 P.112



87411-6B P.48



Tool Chest Set

306 PC.



919-001CRV

66.01 CUFT 11.05



9-9003MRV01 #6 P.72



9-9040SRV #9 P.80



9-1220MRV #9 P.81



9-90217GRV #6 P.74



9-31110MRV #9 P.84



9-91190CRV #9 P.83



9-91124MRV #6 P.75



79094-08C P.482



87419-5B P.48

7911-12 P.494



Tool Set Content

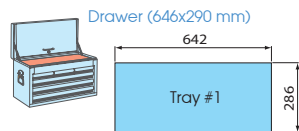

9-7069CRV

Tray category #1 (642 x 286mm)

70 PC.

Contents		7.5	1 / 2
	3330M	6, 7, 8, 9, 10, 11, 12, 13, 14, 15, 16, 17, 19, 20, 21, 22	
	3330S	3/8, 7/16, 1/2, 9/16, 5/8, 11/16, 3/4, 13/16	
	4330MR	10, 11, 12, 13, 14, 15, 16, 17, 18, 19, 20, 21, 22, 23, 24, 27, 30, 32	
	4330SR	3/8, 7/16, 1/2, 9/16, 5/8, 11/16, 3/4, 13/16, 7/8, 15/16, 1	
	463516RC		463521RC 3792
	4791R		3779-08G
	4779-10GR		3812
	3452-08F		4452-15FR
	3812		3571-08
	3571-08		4572-10
	4813		3221-03
	3221-06		4251-05R
	4251-10R		7911-12



9-9077CRV

Tray category #1 (642 x 286mm)

77 PC.

Contents		7.95	1 / 2
	2330M	4, 5, 6, 7, 8, 9, 10	
	2330S	3/16, 7/32, 1/4, 9/32, 5/16, 11/32, 3/8	
	3330M	10, 11, 12, 13, 14, 15, 17, 19	
	3330S	3/8, 7/16, 1/2, 9/16, 5/8, 11/16, 3/4, 13/16	
	4330MR	10, 11, 12, 13, 14, 15, 16, 17, 18, 19, 20, 21, 22, 23, 24, 27, 30, 32	
	4330SR	3/8, 7/16, 1/2, 9/16, 5/8, 11/16, 3/4, 13/16, 7/8, 15/16, 1, 1-1/16, 1-1/8, 1-3/16, 1-1/4	
	463021RC		2792
	3792		3792
	4791R		2779-55G
	2779-55G		3779-08G
	3814		4779-10GR
	4779-10GR		2221-04
	3221-06		4251-10R
	4251-10R		3452-08F
	4452-15FR		4572-12





Tool Set Content

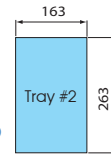
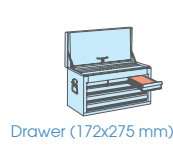

9-2548CRV Tray category #2 (263 x 163mm)



48 PC.

Contents

1.28 kg 1 / 10

	2235M	4, 5, 5.5, 6, 7, 8, 9, 10, 11, 12, 13
	2235S	5/32, 3/16, 7/32, 1/4, 9/32, 5/16, 11/32, 3/8, 7/16, 1/2
	2335M	4, 4.5, 5, 5.5, 6, 7, 8, 9, 10, 11, 12, 13
	2335S	5/32, 3/16, 7/32, 1/4, 9/32, 5/16, 11/32, 3/8, 7/16, 1/2
	2792	
	2813	
	2779-55G	
	2221-02	
	2221-04	

9-40102GPV Tray category #2 (263 x 163mm)



2 PC.

Contents

1.00 kg 1 / 10

	6011-10R		6511-10
--	----------	--	---------

9-40112GPV Tray category #2 (263 x 163mm)



2 PC.

Contents

0.69 kg 1 / 10

	6231-08		6311-08
--	---------	--	---------

9-40122GPV Tray category #2 (263 x 163mm)



2 PC.

Contents

0.95 kg 1 / 10

	6111-08		6011-10R
--	---------	--	----------

9-42102GPV Tray category #2 (263 x 163mm)



2 PC.

Contents

0.32 kg 1 / 10

	68HS-07		68SS-07
--	---------	--	---------

9-42114GPV Tray category #2 (263 x 163mm)



4 PC.

Contents

0.60 kg 1 / 10

	68HS-07		68SS-07
	68HB-07		68SB-07

Tool Set Content

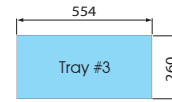
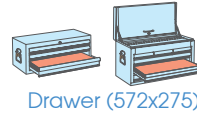

9-91126SRV

Tray category #3 (554 x 260mm)

Contents		3.28 kg	1 / 3
5060	1/4, 5/16, 3/8, 7/16, 1/2, 9/16, 5/8, 11/16, 3/4, 13/16, 7/8, 15/16, 1		
5930	5/16 x 3/8, 3/8 x 7/16, 1/2 x 9/16, 9/16 x 5/8		
1130SR	3/32, 1/8, 5/32, 3/16, 1/4, 5/16, 3/8		
3611R	6, 12		



26 PC.

9-91131MRV

Tray category #3 (554 x 260mm)

Contents		2.98 kg	1 / 4
1930	8x10, 10x12, 11x13, 14x17		
1060	6, 7, 8, 9, 10, 11, 12, 13, 14, 15, 16, 17, 18, 19, 20, 21, 22, 24		
1125MR	H1.5, H2.5, H2, H3, H4, H5, H6, H8, H10		



31 PC.

9-90145CRV

Tray category #3 (554 x 260mm)

Contents		4.04 kg	1 / 3
1060	27, 30, 32		
5060	1-1/16, 1-1/8, 1-1/4		
1481	PH1x75, PH2x100, PH3x150		
1482	5.5x75, 6.5x100, 8x150		
1025S	3.0, 4.0, 5.0, 6.0		
1025P	PH1, PH2 x 2, PH3		
1025Z	PZ1, PZ2 x 2, PZ3		
1025T	T10, T15, T20, T25, T27, T30, T40		
1025H	H3, H4, H5, H6		
1025U	T10H, T15H, T20H, T25H, T27H, T30H, T40H		
7702-25	753-63	2141	



45 PC.

9-90129CRV

Tray category #3 (554 x 260mm)

Contents		2.5 kg	1 / 4
1421	PH0 x 60, PH1 x 80, PH2 x 38, PH2 x 100, PH3 x 150		
1422	3 x 75, 6.5 x 38, 6.5 x 100, 6.5 x 150, 8 x 175		
1130SR	3/32, 1/8, 5/32, 3/16, 1/4, 5/16, 3/8		
1120MR	H1.5, H2, H2.5, H3, H4, H5, H6, H8, H10		
6111-07	6231-07		
6311-06			

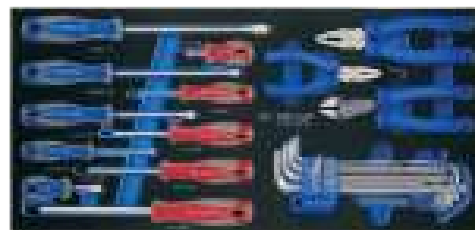

29 PC.



Tool Set Content

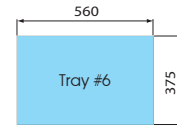
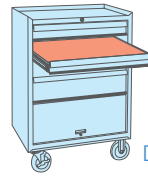

Drawer (579 x 380 mm)



9-6314MRV

Tray category #6 (560 x 375mm)

Contents

9.96 kg 1/2

		6335M	33, 34, 35, 36, 38, 41, 46, 50
	6572-20		6779-20F
	6251-04		6251-08
	6251-16		6814



14 PC.

9-9003MRV01

Tray category #6 (560 x 375mm)

Contents

7.30 kg 1/3

		2235M	4, 4.5, 5, 5.5, 6, 7, 8, 9, 10, 11, 12, 13
		2335M	4, 4.5, 5, 5.5, 6, 7, 8, 9, 10, 11, 12, 13
		3023	T10, T15, T20, T25, T27, T30, T40, T45, T50
		3025	H3, H4, H5, H6, H8, H10, H12
		3235M	10, 12, 13, 14, 15, 16, 17, 18, 19, 21
		3330M	8, 10, 11, 12, 13, 14, 15, 16, 17, 18, 19, 20, 21, 22
		4330MR	10, 12, 13, 14, 15, 16, 17, 18, 19, 20, 21, 22, 23, 24, 27, 28, 30, 32
	7702-50		7703-50
	2792		3792
			4791R
	363516		363521
			36A014

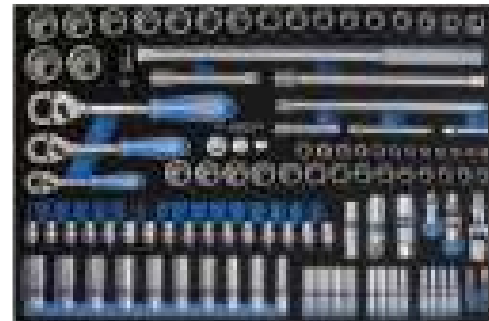

103 PC.

Contents

	2813		3812		4813
	2221-02		3221-03		4251-05R
	2221-04		3221-10		4251-10R
	2771-55G		3771-08G		
	4771-10GR		4462-18F		

9-99430MFV

9-99430MFV01

Tray category #6 (560 x 375mm)



30 PC.

9-99430MFV

Contents

12.38 kg 1/2

		8435M	27, 30, 32, 33, 36
		6575M	E24, E26, E28, E30, E32
		3375M	E4, E5, E6, E7, E8, E11
		4375M	E10, E12, E14, E16, E18, E20, E22
		4025	H14, H17, H19
	8866P		7823-20
	320560		9DC22



31 PC.

9-99430MFV01

Contents

12.38 kg 1/2

		8435M	27, 30, 32, 33, 36
		6575M	E24, E26, E28, E30, E32
		3375M	E4, E5, E6, E7, E8, E11
		4375M	E10, E12, E14, E16, E18, E20, E22
		4025	H14, H17, H19
	4866P		8866P
			7823-20
	320560		9DC22



Tool Set Content

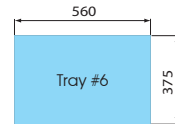
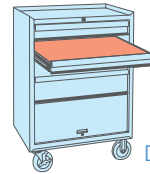

Drawer (579 x 380 mm)



9-44803AMPV

9-44803AMPV01

Tray category #6 (560 x 375mm)

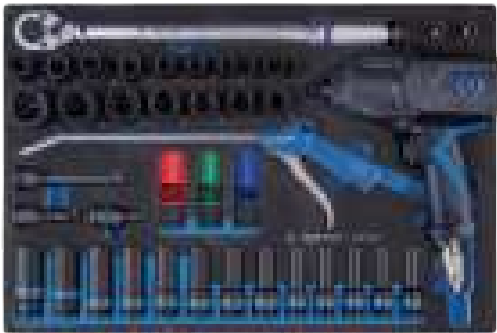

9-44803AMPV



9-44803AMPV01

41 PC.

KT NO.	Contents		kg 9.50	1/2
9-44803AMPV	33481-095	<ul style="list-style-type: none"> 4945M 17, 19, 21 4435M 10, 11, 12, 13, 14, 15, 16, 17, 18, 19, 21, 22, 24 	<ul style="list-style-type: none"> 79900-10 34423-1A 	
9-44803AMPV01	33411-050	<ul style="list-style-type: none"> 4535M 10, 11, 12, 13, 14, 15, 16, 17, 18, 19, 21, 22, 24, 27, 30, 32 	<ul style="list-style-type: none"> 4797P 4260-03P 4260-05P SY-211M x2 33411-71 	

9-44805AMPV

Tray category #6 (560 x 375mm)

Contents		kg 9.76	1/2
4945M	17, 19, 21		
4435M	10, 11, 12, 13, 14, 15, 16, 17, 18, 19, 21, 22, 24		
4535M	10, 11, 12, 13, 14, 15, 16, 17, 18, 19, 21, 22, 24, 27, 30, 32		
33481-095	37435-075	33411-71	
34423-1A	SY-211M x2		
4797P	4260-03P	4260-05P	



41 PC.

9-94437MRV

Tray category #6 (560 x 375mm)

Contents		kg 4.61	1/2
1060	8, 9, 10, 11, 12, 13, 14, 15, 16, 17, 18, 19, 20, 21, 22, 23, 24		
3731M	8, 10, 11, 12, 13, 14, 15		
4435M	17, 19, 21		
1836P	PH2, PH3		
1836S	9, 11		
1880P	PH2, PH3		
1880S	8, 10		
4112	414810S		



37 PC.

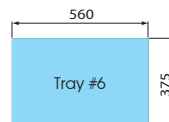
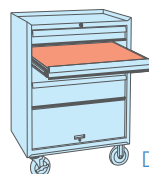

Drawer (579 x 380 mm)



Tool Set Content

9-90217GRV

Tray category #6 (560 x 375mm)

Contents

3.89 1 / 6

764	3,4,5,6		
76105-06		76717-05	
7811-16		6011-10R	
6111-08	6231-07	6311-08	
6314-05	68HB-07	68HS-07	
68SB-07	68SS-07	6511-10C	



17
PC.

9-91122MRV

Tray category #6 (560 x 375mm)

Contents

3.18 1 / 5

1060	8, 9, 10, 11, 12, 13, 14, 15, 16, 17, 19, 21, 22, 24		
115HM	H6, H7, H8, H9, H10, H11, H12, H13		



22
PC.

9-22124MRV50

Tray category #6 (560 x 375mm)

Contents

2.18 1 / 5

115HM	H7, H8, H10, H11, H12, H13		
ST20109MR		ST20419PR	



24
PC.

9-31920MRV

Tray category #6 (560 x 375mm)

Contents

2.01 1 / 2

1421	PH0 x 60, PH2 x 38, PH2 x 300		
1422	3 x 75, 6.5 x 38, 6.5 x 300		
1427	T8H x 75, T10H x 75, T15H x 75, T20H x 100, T25H x 100, T27H x 100, T30H x 125,		
1461	PH2 x 100, PH3 x 150		
1462	6.5 x 100, 8 x 150		
43280212		48280180	
2121-18			

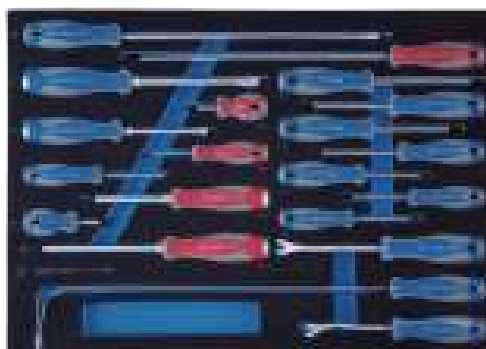

20
PC.



Tool Set Content

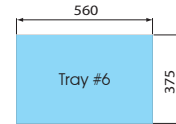
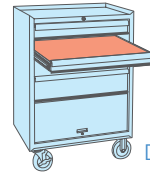

Drawer (579 x 380 mm)



9-31124MRV

Tray category #6 (560 x 375mm)

Contents

2.41 kg 1 / 5

⊕	1421	PH2x38, PH1x80, PH2x100, PH3x150
⊖	1422	3x75, 4x100, 5.5x100, 6.5x100, 10x200, 6.5x38
⊛	1423	T6x48, T7x48, T8x75, T9x75, T10x75, T15x75, T15x250, T20x100, T20x250, T25x100, T25x250, T27x100, T30x125, T30x250

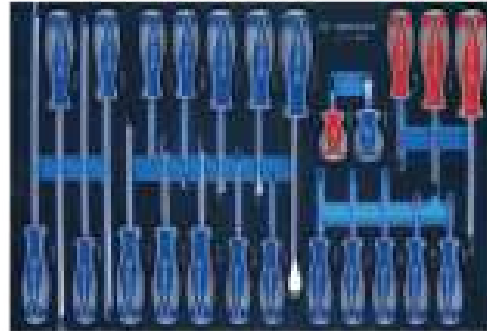

24 PC.

9-91124MRV

Tray category #6 (560 x 375mm)

Contents

4.12 kg 1 / 5

	3731	10, 12, 13, 14, 17, 18, 19
⊕	1421	PH2 x 300
⊖	1422	5 x 300
	74030	6615-11
	3611-10R 3611-12R	9TK118
	79063-12	11409SQ05



24 PC.



9-90413TQV

Tray category #6 (560 x 375mm)

Contents

2.49 kg 1 / 5

⊙	115HM	8, 10, 13
	9CZ101	115345R
	48280180	43280212
	43240115Y	75102-08G
	75202-08G	75302-08G
	75402-08G	75502-08G



13 PC.

9-91217MRV

Tray category #6 (560 x 375mm)

Contents

6.11 kg 1 / 2

⊕	1421	PH1 x 80, PH2 x 100
⊖	1422	3 x 75, 4 x 100, 5.5 x 125, 6.5 x 150, 8 x 175
⊛	1423	T15 x 75, T20 x 100, T25 x 100, T27 x 100, T30 x 125
	48280180	9CF220
	7823-10 7823-20	7821-30



17 PC.



Tool Set Content

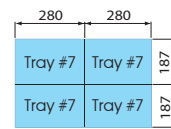
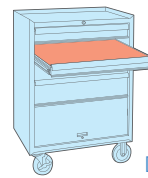

Drawer (579 x 380 mm)



9-2331SRV

Tray category #7 (280 x 187mm)

Contents

0.97 kg 1 / 10

- 2335S 5/32, 3/16, 7/32, 1/4, 9/32, 5/16, 11/32, 3/8, 7/16, 15/32, 1/2, 9/16
- 2235S 5/32, 3/16, 7/32, 1/4, 9/32, 5/16, 11/32, 3/8, 7/16, 1/2, 9/16
- 2771-55G 2571-45 2142
- 2221-02 2221-04 2221-06 2792 2178DF

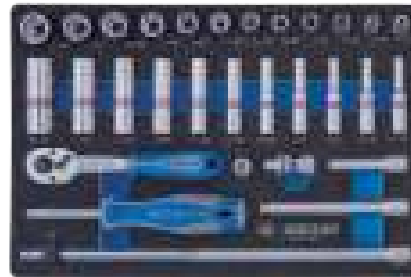

31 PC.

9-2534MRV

Tray category #7 (280 x 187mm)

Contents

1.11 kg 1 / 10

- 2335M 4, 4.5, 5, 5.5, 6, 7, 8, 9, 10, 11, 12, 13, 14
- 2235M 4, 4.5, 5, 5.5, 6, 7, 8, 9, 10, 11, 12, 13, 14
- 2771-55G 2571-45
- 2792 2178DF 2142
- 2221-02, 2221-04, 2221-06

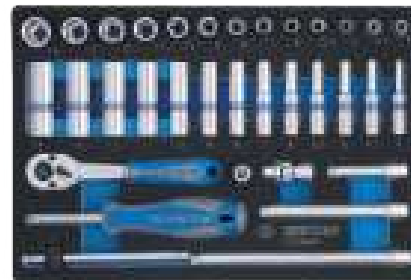

34 PC.

9-2565MRV

Tray category #7 (280 x 187mm)

Contents

1.38 kg 1 / 10

- 2335M 4, 4.5, 5, 5.5, 6, 7, 8, 9, 10, 11, 12, 13, 14
- 2235M 4, 4.5, 5, 5.5, 6, 7, 8, 9, 10, 11, 12, 13, 14
- 2375M E4, E5, E6, E7, E8
- 2013X T8, T9, T10, T15, T20, T25, T27, T30, T40
- 2015X H3, H4, H5, H6, H8
- 2018X PZ1, PZ2
- 2011X PH1, PH2
- 2012X 3.5, 5.5, 8
- 1025T T6, T7
- 1025M M4, M5, M6, M8, M10

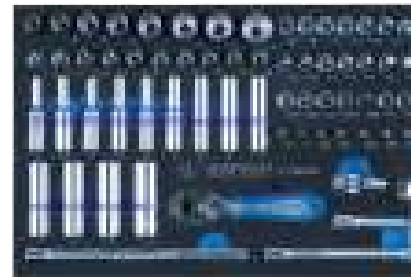

65 PC.

Contents

- 2792 2813 276A-04G
- 2221-02, 2221-04, 2221-06

9-4138PRV

Tray category #7 (280 x 187mm)

Contents

1.85 kg 1 / 10

- 4033 T20, T25, T27, T30, T40, T45, T50, T55, T60
- 4035 H4, H5, H6, H7, H8, H10, H12, H14, H17



18 PC.

9-4129PRV

Tray category #7 (280 x 187mm)

Contents

2.07 kg 1 / 10

- 4025 H3, H4, H5, H6, H7, H8, H10, H12, H14, H17, H19
- 4026 M5, M6, M8, M10, M12, M14
- 402B M16, M18



19 PC.

Tool Set Content

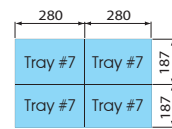
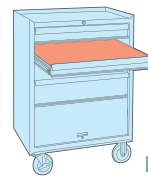

Drawer (579 x 380 mm)



9-7128PRV

Tray category #7 (280 x 187mm)

Contents

1.30 kg 1 / 10

	3023	T15, T20, T25, T27, T30, T40, T45, T50
	3025	H3, H4, H5, H6, H7, H8, H10, H12
	3375	E8, E10, E12, E14, E16, E18
	4375	E10, E12, E14, E16, E18, E20



28 PC.

9-4429MPV

Tray category #7 (280 x 187mm)

Contents

2.75 kg 1 / 4

	4535M	10, 11, 12, 13, 14, 15, 16, 17, 18, 19, 21, 22, 24, 27, 30, 32, 33, 34, 36
--	-------	--



19 PC.

9-10112MRV

Tray category #7 (280 x 187mm)

Contents

1.13 kg 1 / 10

	3731	10, 11, 12, 13, 14, 15, 16, 17, 19
	373202R	
	373203R	
	373204R	



12 PC.

9-4143FRV

Tray category #7 (280 x 187mm)

Contents

1.63 kg 1 / 8

	1636H	H5, H6, H7, H8, H10, H12
	1636M	M6, M8, M10, M12
	1636T	T30, T40, T45, T50, T55, T60
	1832H	H3, H4, H5, H6, H7, H8, H10, H12
	1832T	T15, T20, T25, T27, T30, T40, T45, T50
	1836P	PH2, PH3
	1836S	9 x 1.6, 11 x 2
	1880P	PH2, PH3



43 PC.

Contents

	1880S	8 x 1.2, 10 x 1.6
	414810M, 414810S	
	4112	

9-25VE01MRV

Tray category #7 (280 x 187mm)

Contents

1.30 kg 1 / 10

	2335VE	5, 6, 7, 8, 9, 10, 11, 12, 13, 14,
	2035VE	H3, H4, H5, H6
	2221VE	4, 6
	2771VE-55	2178VE-05



18 PC.



Tool Set Content

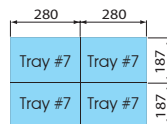
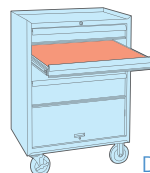

Drawer (579 x 380 mm)



9-30904AYV

Tray category #7 (280 x 187mm)

Contents

0.45 kg 1 / 10

- | | |
|-----------|-----------|
| 43250115Y | 43270115Y |
| 43260115Y | 43290115Y |



4 PC.

Tool Set Content

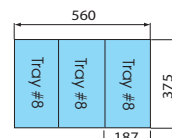
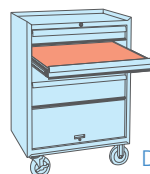

Drawer (579 x 380 mm)



9-35VE01MRV

Tray category #8 (375 x 187mm)

Contents

2.16 kg 1 / 6

- | | |
|-----------|----------------------------|
| 3335VE | 10, 11, 12, 13, 14, 17, 19 |
| 3025VE | H5, H6, H8 |
| 3221VE | 6, 10, |
| 3771VE-08 | 3178VE-08 |



14 PC.

9-45VE01MRV

Tray category #8 (375 x 187mm)

Contents

3.22 kg 1 / 6

- | | |
|-----------|---------------------------------------|
| 4335VE | 8, 10, 12, 13, 14, 17, 19, 21, 22, 24 |
| 4025VE | H8, H10 |
| 4251VE | 5, 10 |
| 4771VE-10 | 4178VE-08 |

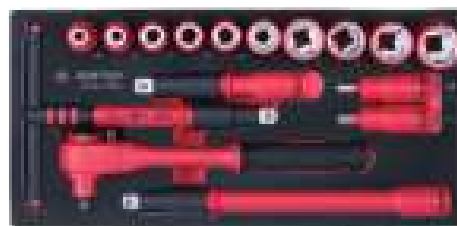

16 PC.

9-2550MRV

Tray category #8 (375 x 187mm)

Contents

1.37 kg 1 / 15

- | | |
|-------|--|
| 2335M | 4, 4.5, 5, 5.5, 6, 7, 8, 9, 10, 11, 12, 13, 14 |
| 2375M | E4, E5, E6, E7, E8 |
| 2031 | PH1, PH2, PH3, PH4 |
| 2032 | 4, 5.5, 6.5, 8, 10 |
| 2033 | T8, T9, T10, T15, T20, T25, T27, T30, T40 |
| 2035 | H3, H4, H5, H6, H7, H8, H10 |



50 PC.

Contents

- | | |
|----------|---------|
| 2771-55G | 2178DF |
| 2792 | 2571-45 |
| 2293-04 | 2221-02 |
| 2293-06 | |



Tool Set Content

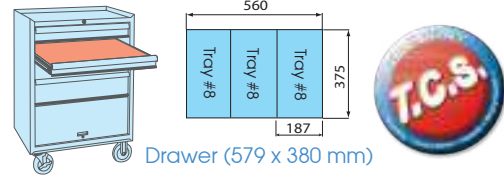

Drawer (579 x 380 mm)

9-30909AYV Tray category #8 (375 x 187mm)

- Use for scribing, alignment, installing and removing O rings, seals, cotter pins and washers
- Use for removing old gaskets more easily and quickly

Contents		0.89	1 / 12
	43250115Y		43350175Y
	43260115Y		43360175Y
	43270115Y		43370175Y
	43290115Y		43390175Y
	43240115Y		

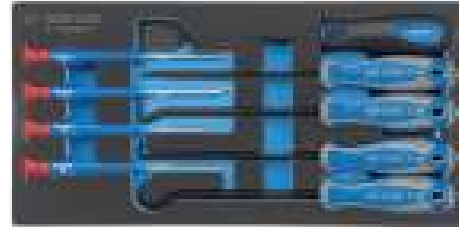

9 PC.

Tray category #8 (375 x 187mm)

Tool Set Content

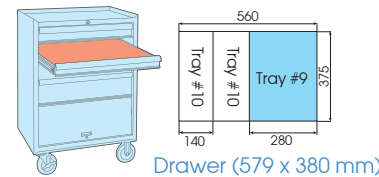

Drawer (579 x 380 mm)

9-3544MRV Tray category #9 (375 x 280mm)

Contents		3.19	1 / 5
	3335M	10, 11, 12, 13, 14, 15, 16, 17, 18, 19, 20, 21, 22	
	3375M	E7, E8, E10, E11, E12	
	3230M	8, 10, 11, 12, 13, 14, 16, 17, 19	
	3750M	10, 11, 12, 13, 14, 15, 16, 17, 18, 19	
	3812		3221-03
	3814		3221-06
	3223-14		3779-08G
			3221-10



44 PC.

Tray category #9 (375 x 280mm)

9-4221MRV Tray category #9 (375 x 280mm)

Contents		3.97	1 / 5
	4230	8, 9, 10, 11, 12, 13, 14, 15, 16, 17, 18, 19, 21, 22, 24, 27, 30, 32, 33, 34, 36	

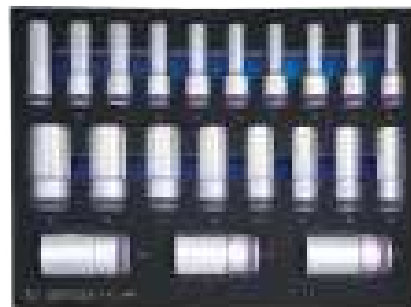

21 PC.

9-4526MRV05 Tray category #9 (375 x 280mm)

Contents		5.05	1 / 4
	4335MR	8, 10, 11, 12, 13, 14, 15, 16, 17, 18, 19, 21, 22, 23, 24, 27, 30, 32	
	4779-10FR		4572-12
	4452-15FR		4251-05R
	4791R		4251-10R



24 PC.



Tool Set Content

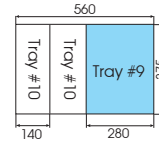
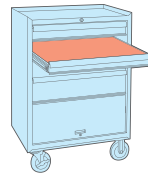

Drawer (579 x 380 mm)

9-4527MRV02

Tray category #9 (375 x 280mm)

Contents

4.72 1 / 5

		4335MR	8, 9, 10, 11, 12, 13, 14, 15, 16, 17, 18, 19, 21, 22, 23, 24, 27, 29, 30, 32
		4771-10GR	4791R
		4572-12	4251-05R 4251-10R
		4452-15FR	4581-10



27
PC.

9-4537MRV

Tray category #9 (375 x 280mm)

Contents

4.39 1 / 5

		4335MR	8, 10, 11, 12, 13, 14, 15, 16, 17, 18, 19, 20, 21, 22, 23, 24, 26, 27, 28, 30, 32
		4375M	E10, E12, E14, E16, E18, E20, E22, E24
		4779-10GR	4293-02
		4251-05R 4251-10R	463516RC 463521RC
		4791R	463014RC



37
PC.

9-9040SRV

Tray category #9 (375 x 280mm)

Contents

3.02 1 / 5

		2335S	5/32, 3/16, 7/32, 1/4, 9/32, 5/16, 11/32, 3/8, 7/16, 1/2
		3330S	3/8, 7/16, 1/2, 9/16, 5/8
		4330SR	3/8, 7/16, 1/2, 9/16, 5/8, 11/16, 3/4, 13/16, 7/8, 15/16, 1, 1-1/8, 1-1/4,
		5060	1/4, 5/16, 3/8, 7/16, 1/2, 9/16, 5/8, 11/16, 3/4, 7/8, 15/16, 1



40
PC.

9-7560MRV01

Tray category #9 (375 x 280mm)

Contents

6.24 1 / 2

		2335M	4, 5, 5.5, 6, 7, 8, 9, 10, 11, 12, 13, 14
		4335MR	10, 11, 13, 14, 15, 16, 17, 18, 19, 20, 21, 22, 24, 27, 30, 32
		1025S	3, 4.5, 5, 6.5, 8
		1025P	PH0, PH1, PH2, PH3
		1025U	T10H, T15H, T20H, T25H, T27H, T30H, T40H
		1025Z	PZ1, PZ2, PZ3
		276A-04G	4771-10GR
		4452-15FR	4572-12
		213312DF	2792
			4791R
		2223-02 2223-04	4251-05R 4251-10R
			2813



60
PC.

Tool Set Content

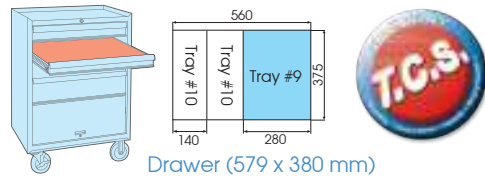

Drawer (579 x 380 mm)

9-4419MPV

Tray category #9 (375 x 280mm)

Contents		5.6 kg	1 / 2
 4435M	10, 11, 12, 13, 14, 15, 16, 17, 18, 19, 21, 22, 24, 27, 30, 32, 33, 34, 36		

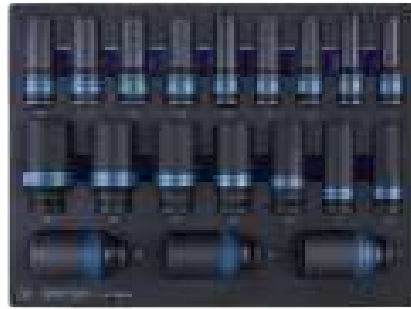

19 PC.

9-6414MPV

Tray category #9 (375 x 280mm)

Contents		10.08 kg	1 / 2
 6435M	19, 21, 22, 24, 26, 27, 29, 30, 32, 33, 35, 36, 38, 41		



14 PC.

9-1220MRV

Tray category #9 (375 x 280mm)

Contents		3.49 kg	1 / 4
 1060	6, 7, 8, 9, 10, 11, 12, 13, 14, 15, 16, 17, 18, 19, 21, 22, 24, 27, 30, 32		



20 PC.

9-12D20MRV

Tray category #9 (375 x 280mm)

Contents		3.45 kg	1 / 4
 1062	6, 7, 8, 9, 10, 11, 12, 13, 14, 15, 16, 17, 18, 19, 21, 22, 24, 27, 30, 32		

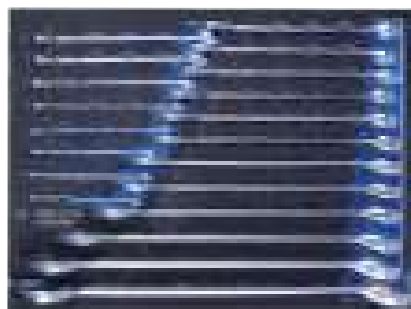

20 PC.



Tool Set Content

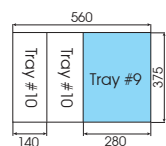
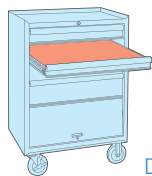

Drawer (579 x 380 mm)

Tray category #9 (375 x 280mm)

9-12A1MRV

Contents

1.75 kg 1 / 10

1061 8, 10, 12, 13, 14, 16, 17, 18, 19, 22, 24



11 PC.

9-1112MRV

Tray category #9 (375 x 280mm)

Contents

2.34 kg 1 / 4

1900 6x7, 8x9, 10x11, 12x13, 14x15, 16x17, 18x19, 20x22, 21x23, 24x27, 25x28, 30x32



12 PC.

9-90119MRV

Tray category #9 (375 x 280mm)

Contents

3.04 kg 1 / 4

1970 6x7, 8x9, 10x11, 12x13, 14x15, 16x17, 18x19, 20x22, 24x27, 30x32
 1143 T10, T15, T20, T25, T27, T30, T40, T45, T50

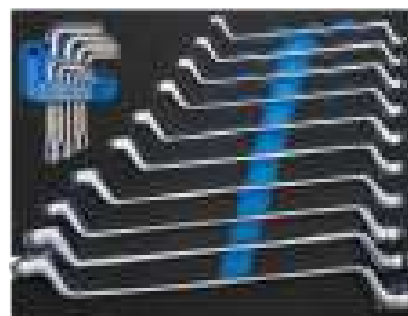

19 PC.

9-42116GPV

Tray category #9 (375 x 280mm)

Contents

1.54 kg 1 / 5

	68SB-07		68HS-07		68SS-07
	68HB-07		68HS-10		68SS-10



6 PC.

Tool Set Content

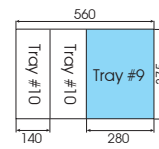
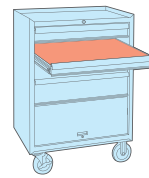

Drawer (579 x 380 mm)



9-91190CRV

Tray category #9 (375 x 280mm)

Contents

2.22 kg 1 / 10

⊖	1025S	3.0, 4.0, 5.0, 6.0
⊕	1025P	PH1, PH2 x 2, PH3
⊗	1025Z	PZ1, PZ2 x 2, PZ3
⊛	1025T	T10, T15, T20, T25, T27, T30, T40
⊙	1025H	H3, H4, H5, H6
⊛	1025U	T10H, T15H, T20H, T25H, T27H, T30H, T40H
⊙	1025R	RB2
■	7702-25	753-63
	10D0	10, 12, 13, 14, 17, 18, 19
⊙	1130MR	H2.5, H3, H4, H5, H6, H8, H10



90 PC.

Contents

⊙	1130SR	3/32, 1/8, 5/32, 3/16, 1/4, 5/16, 3/8
⊛	1147R	T10H, T15H, T20H, T25H, T27H, T30H, T40H
	3611-06R	77328-26
	3611-08R	
	276A-04G	

9-22108MRV

Tray category #9 (375 x 280mm)

Contents

0.89 kg 1 / 5

⊙	1160MR	H2, H2.5, H3, H4, H5, H6, H8, H10
---	--------	-----------------------------------



8 PC.

9-22308TRV

Tray category #9 (375 x 280mm)

Contents

0.71 kg 1 / 10

⊛	1163TR	T10, T15, T20, T25, T30, T40, T45, T50
---	--------	--



8 PC.

9-30208MRV

Tray category #9 (375 x 280mm)

Contents

1.41 kg 1 / 5

⊕	1461	PH1 x 75, PH2 x 100, PH3 x 150
⊖	1462	5.5 x 100, 6.5 x 100, 6.5 x 150, 8 x 150, 8 x 175

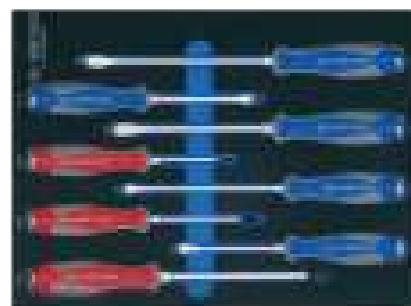

8 PC.



Tool Set Content

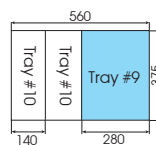
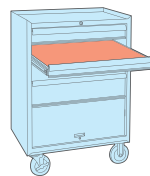

Drawer (579 x 380 mm)



9-31110MRV

Tray category #9 (375 x 280mm)

Contents

2.46 1 / 5

	1421	PH1 x 80, PH2 x 100, PH3 x 150, PH2 x 38
	1422	3 x 75, 4 x 100, 5.5 x 125, 6.5 x 38, 6.5 x 150, 8 x 175

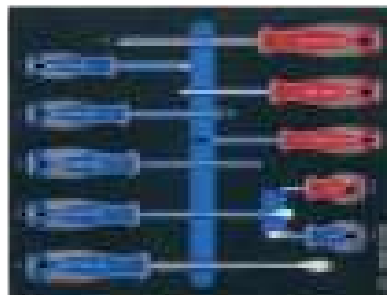

10 PC.

9-55VE01MRV

Tray category #9 (375 x 280mm)

Contents

2.34 1 / 5

	2335VE	5, 6, 7, 8, 9, 10, 11, 12, 13, 14,
	2035VE	H3, H4, H5, H6
	2221VE	4, 6
	3335VE	10, 11, 12, 13, 14, 15, 16, 17, 18, 19
	3235VE	8, 10, 12, 14
	3025VE	H8, H10
	3221VE	6, 10
	2771VE-55	2178VE-05
	3771VE-08	3178VE-08

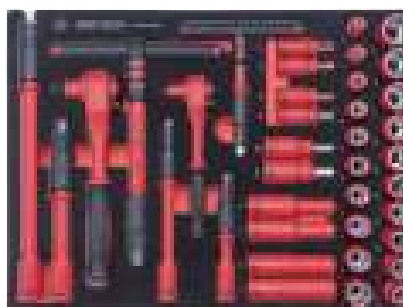

Tray category #9 (375 x 280mm)



38 PC.

9-12FVE15MRV

Tray category #9 (375 x 280mm)

Contents

1.96 1 / 10

	10F0	7, 8, 9, 10, 11, 12, 13, 14, 16, 17, 18, 19, 21, 22, 24
--	------	---



15 PC.

9-12FVG15MRV

Tray category #9 (375 x 280mm)

Contents

2.86 1 / 5

	10G0	7, 8, 9, 10, 11, 12, 13, 14, 16, 17, 18, 19, 21, 22, 24
--	------	---



15 PC.

Tool Set Content

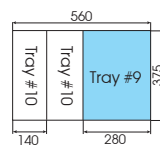
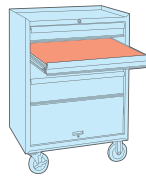

Drawer (579 x 380 mm)



9-30612MRV

Tray category #9 (375 x 280mm)



12 PC.

Contents		kg 1.30	1 / 10
⊕ 1471	PH0 x 75, PH1 x 100, PH2 x 100, PH3 x 150		
⊖ 1472	3 x 75, 4 x 100, 3.5 x 100, 5.5 x 125, 6.5 x 150, 8 x 175		
⦿ 1474	1 x 125, 2 x 150		

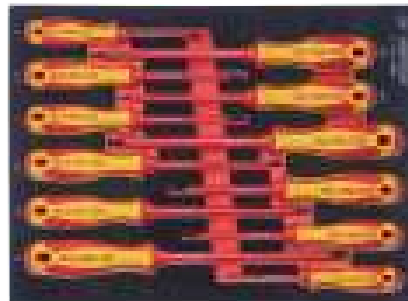

9-40606GPV

Tray category #9 (375 x 280mm)



6 PC.

Contents		kg 1.88	1 / 10
6216-06A	6116-07A		
6318-08A	6336-08A		
6716-06A	6146-08A		

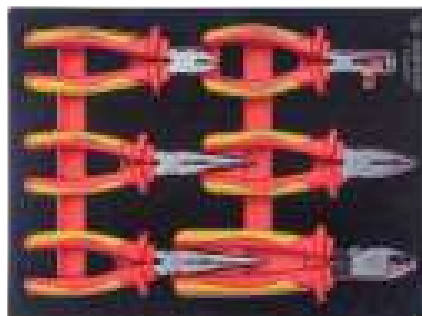



Tool Set Content

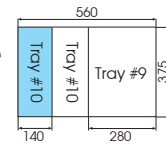
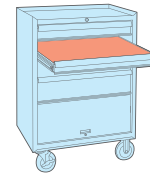

Drawer (579 x 380 mm)

9-2544SRV

9-2044SRV

Tray category #10 (375 x 140mm)







9-2544SRV



9-2044SRV

44
PC.

KT NO.	Contents		kg 0.92	1 / 6
9-2544SRV	 2335S	5/32, 3/16, 7/32, 1/4, 9/32, 5/16, 11/32, 3/8, 7/16, 15/32, 1/2	 2235S	5/32, 3/16, 7/32, 1/4, 9/32, 5/16, 11/32, 3/8, 7/16, 1/2
			 1025S	3, 4.5, 5, 6.5, 8
			 1025P	PH0, PH1, PH2, PH3
			 1025H	H3/64, H1/16, H5/64, H3/32, H7/64, H1/8, H9/64, H5/32
				2752-06G
				2178DF
				2792
				2223-02
				2223-04
				2142

9-2548MRV

9-2048MRV

Tray category #10 (375 x 140mm)







9-2548MRV



9-2048MRV

48
PC.

KT NO.	Contents		kg 1.09	1 / 6
9-2548MRV	 2335M	4, 4.5, 5, 5.5, 6, 7, 8, 9, 10, 11, 12, 13, 14	 2235M	4, 4.5, 5, 5.5, 6, 7, 8, 9, 10, 11, 12, 13, 14
			 1025S	3, 4.5, 5, 6.5, 8
			 1025P	PH0, PH1, PH2, PH3
			 1025H	H3, H4, H5, H6, H7, H8, H10
				2752-06G
				2178DF
				2792
				2223-02
				2223-04
				2142

Tool Set Content

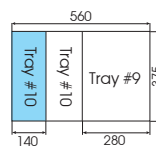
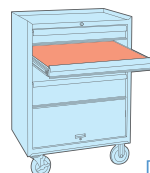

Drawer (579 x 380 mm)



9-2553MRV Tray category #10 (375 x 140mm)

Contents		0.98 kg	1 / 6
	2335M 4, 5, 5.5, 6, 7, 8, 9, 10, 11, 12, 13, 14		
	1025H H3, H4, H5, H6, H7, H8, H10		
	1025S 3, 4.5, 5, 6.5, 8		
	1025P PH0, PH1, PH2, PH3		
	1025U T10H, T15H, T20H, T25H, T27H, T30H, T40H		
	1025Z PZ1, PZ2, PZ3		
	1025T T10, T15, T20, T25, T27, T30, T40		



53 PC.

Contents	
7702-25	2792 2813
276A-04G	213312DF
2223-02 2223-04	2745

9-2553MRV01 Tray category #10 (375 x 140mm)

Contents		0.97 kg	1 / 6
	2335M 4, 4.5, 5, 5.5, 6, 7, 8, 9, 10, 11, 12, 13, 14		
	1025H H3, H4, H5, H6, H7, H8, H10		
	1025T T10, T15, T20, T25, T27, T30, T40		
	1025U T10H, T15H, T20H, T25H, T27H, T30H, T40H		
	1025P PH1, PH2, PH3		
	1025Z PZ1, PZ2, PZ3		
	1025S 3, 4.5, 5, 6.5, 8		



55 PC.

Contents	
7702-25	276A-04G
2571-45	213312DF
2221-02 2221-04 2221-06	2745 2792 2142

9-3523MRV10 Tray category #10 (375 x 140mm)

Contents		1.73 kg	1 / 6
	3335M 6, 7, 8, 9, 10, 11, 12, 13, 14, 15, 16, 17, 19, 21, 22, 23, 24		
	3771-08G 3792		
	3571-08 3452-08F		
	3293-03 3293-06		



23 PC.

9-3523MRV11 9-3023MRV11 Tray category #10 (375 x 140mm)

KT NO.	Contents		1.09 kg	1 / 6
9-3523MRV11		3335M 6, 7, 8, 9, 10, 11, 12, 13, 14, 15, 16, 17, 18, 19, 21, 22, 24		
			3771-08G	
			3293-03 3293-06	
9-3023MRV11		3330M 6, 7, 8, 9, 10, 11, 12, 13, 14, 15, 16, 17, 18, 19, 21, 22, 24		
			3453-08	
			3571-08	
			3792	



9-3523MRV11

23 PC.



9-3023MRV11





Tool Set Content

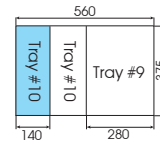
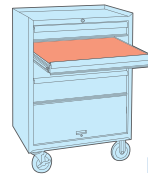

Drawer (579 x 380 mm)



9-4147PRV

Tray category #10 (375 x 140mm)

Contents

1.81 kg 1 / 5

	40D0	H6, H8, H10
	4066	M8, M9, M10, M12, M14
	4023	T20, T25, T27, T30, T40 T45, T50, T55, T60



17 PC.

9-4401MPV

Tray category #10 (375 x 140mm)

Contents

2.23 kg 1 / 6

	4945M	17, 19, 21
	4535M	17, 19, 32, 34, 36
	4415M	17, 19, 21



11 PC.

9-90135MRV

Tray category #10 (375 x 140mm)

Contents

1.81 kg 1 / 6

	1930	8x10, 10x12, 11x13, 12x14, 17x19, 19x22
	1120MR	H1.5, H2, H2.5, H3, H4, H5, H6, H8, H10



15 PC.

9-90135SRV

Tray category #10 (375 x 140mm)

Contents

1.28 kg 1 / 6

	5930	5/16 x 3/8, 3/8 x 7/16, 1/2 x 9/16, 9/16 x 5/8, 11/16 x 3/4, 3/4 x 7/8
	1125SR	1/16, 5/64, 3/32, 1/8, 5/32, 3/16, 1/4, 5/16, 3/8



15 PC.

9-40104GPV

Tray category #10 (375 x 140mm)

Contents

1.08 kg 1 / 8

	6311-08		6111-06
	6231-07		6319-11C



4 PC.

9-40113GPV

Tray category #10 (375 x 140mm)

Contents

1.12 kg 1 / 8

	6011-10R		6516-10C		6314-05
--	----------	--	----------	--	---------



3 PC.

9-44214GPV

Tray category #10 (375 x 140mm)

Contents

1.08 kg 1 / 8

	67HS-07		67HB-07		68SS-07		68SB-07
--	---------	--	---------	--	---------	--	---------



4 PC.

Tool Set Content

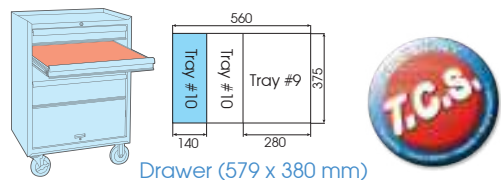

9-30216MRV Tray category #10 (375 x 140mm)

Contents		kg 0.71	1 / 6
	1461 PH2 x 100, PH3 X 150		
	1462 5.5 X 100, 6.5 X 150		
	1411 PH2 x 38		
	1412 6.5 x 38		



6 PC.

9-1044CQV Tray category #10 (375 x 140mm)

Contents		kg 1.75	1 / 6
	1636H H4, H5, H6, H7, H8, H10, H12		
	1680H H4, H5, H6, H7, H8, H10, H12		
	1636M M5, M6, M8, M10, M12		
	1680M M5, M6, M8, M10, M12		
	1636T T20, T25, T27, T30, T40, T45, T50, T55, T60		



44 PC.

Contents	
	1680T T20, T25, T27, T30, T40, T45, T50, T55, T60
	314810M
	414810M

9-90118PRV Tray category #10 (375 x 140mm)

Contents		kg 1.28	1 / 6
	76104-05		7821-30
	76217-06		76403-06
	76220-07		76404-06
			76405-65
			76406-07



8 PC.

9-90305TQV 9-90305TQV01 Tray category #10 (375 x 140mm)



5 PC.

9-90305TQV



9 PC.

9-90305TQV01

KT NO.	Contents		kg 0.91	1 / 6
9-90305TQV		9BM120		7971-07
9-90305TQV01		11205SQ		77141-08
				77335-25
				79093-05C

9-21-20-07MRV Tray category #10 (375 x 140mm)

Contents		kg 0.91	1 / 6	Each Q'ty
	4 x 8 mm		4 x 10 mm	20
	4 x 8 mm		4 x 10 mm	
	4.8 x 8 mm		4.8 x 10 mm	
	21-20-101			1



121 PC.





Tool Set Content

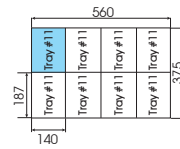
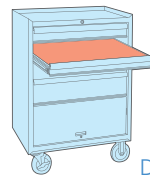

Drawer (579 x 380 mm)



9-2516MRV03

Tray category #11 (187 x 140mm)

Contents

0.47 kg 1 / 12

- 2335M 4, 4.5, 5, 5.5, 6, 7, 8, 9, 10, 11, 12, 13, 14
- 2771-55G 2792
- 2221-06 2792



17 PC.

9-2524MRV

Tray category #11 (187 x 140mm)

Contents

0.63 kg 1 / 12

- 2335M 4, 4.5, 5, 5.5, 6, 7, 8, 9, 10, 11, 12, 13, 14
- 2771-55G 2571-45 2142
- 2221-02 2221-04 2221-06 2792 2178DF



21 PC.

9-2528MRV

Tray category #11 (187 x 140mm)

Contents

0.48 kg 1 / 12

- 2335M 4, 4.5, 5, 5.5, 6, 7, 8, 9, 10, 11, 12, 13, 14
- 1025H H3, H4, H5, H6
- 1025S 4, 5
- 1025T T10, T15, T20, T30
- 1025P PH1, PH2
- 276A-04G 2792
- 2221-06 2142



29 PC.

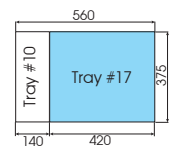
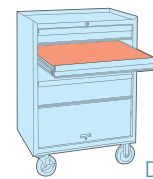

Drawer (579 x 380 mm)

9-91113SRV

Tray category #17 (375 x 420mm)

Contents

3.65 kg 1 / 5

- 5970 1/4 x 5/16, 3/8 x 7/16, 1/2 x 9/16, 5/8 x 11/16, 3/4 x 7/8, 15/16 x 1, 1-1/16 x 1-1/8, 1-1/8 x 1-1/4, 1-3/16 x 1-5/16
- 3812 2813 3814 4813



13 PC.

Tool Set Content

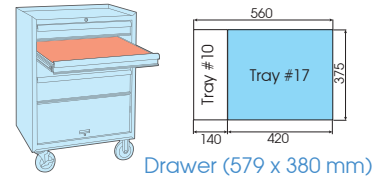

9-45VE02MRV

Tray category #17 (375 x 420mm)



32 PC.

Contents	3.96 kg	1 / 4
4335VE	8, 10, 11, 12, 13, 14, 15, 16, 17, 18, 19, 20, 21, 22, 24, 27, 30, 32	
4025VE	H4, H5, H6, H8, H10	
4035VE	H4, H5, H6, H8, H10	
4251VE	5, 10	
4771VE-10	4178VE-08	





Fill Your Drawer

How to complete your tool trolley set and tool chest set

The drawer of tool chest includes one top drawer and different size



- Do not move the box / trolley unit unless you have closed the cover and locked the drawers
- Never open more than one loaded drawer at the same time
- Watch for sharp edges, we suggest to put on gloves before you lift the unit

Drawer (646x290 mm)

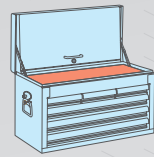

Drawer (172x275 mm)

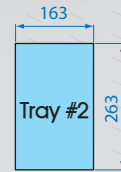
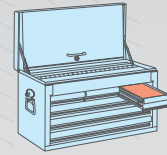

Drawer (572x275 mm)

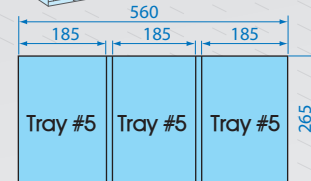
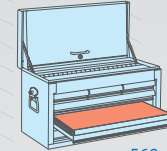
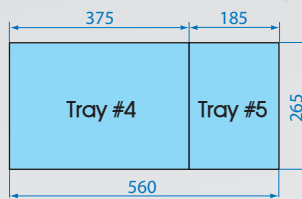
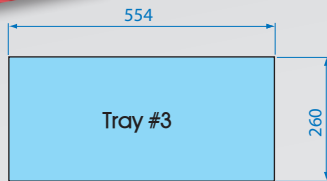
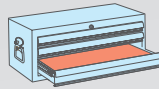

Drawer (579x380 mm)

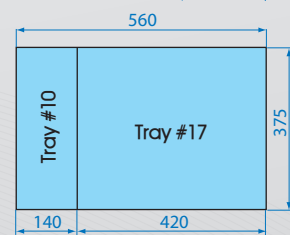
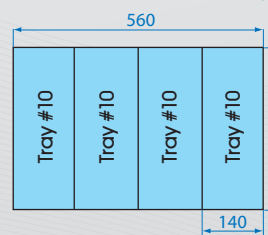
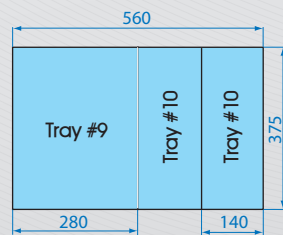
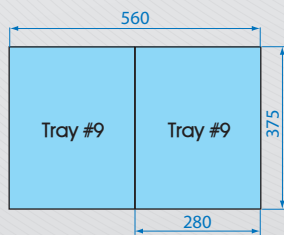
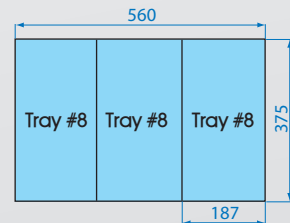
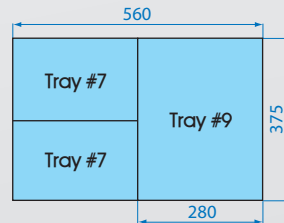
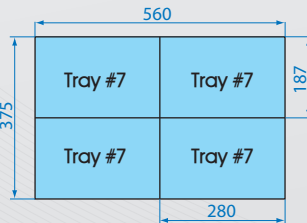
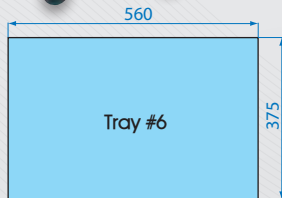
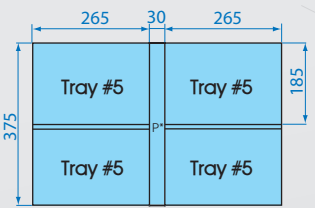
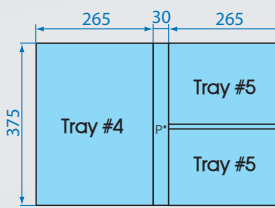
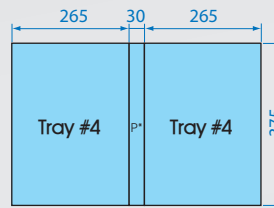
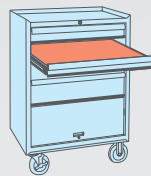

Drawer (504 x 195 mm)

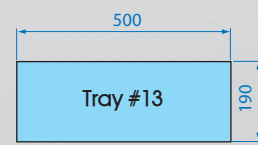
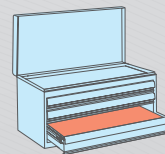
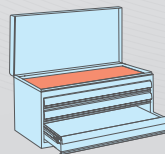

87402 Drawer (470 x 220 mm) #14
87408 Drawer (530 x 220 mm) #15

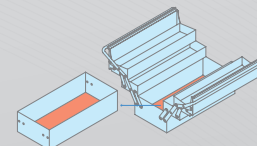
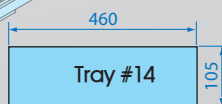
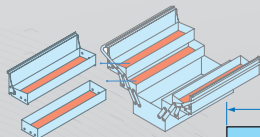
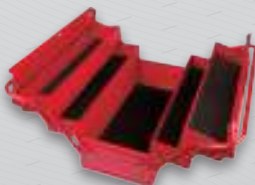

Tool Trolley Contents

101 PC.



Contents No. 932-009MRD

19.80 CUFT 2.41



9-4333MR #4 P.114



9-4120PR #5 P.123
9-4119PR #5 P.123

84700612B



9-1219MR01 #4 P.116



9-1711MR #4 P.118

84700612B



9-90106SR #4 P.121



9-40103GP #5 P.124

84700612B



1110MR P.326



34423-1A P.305

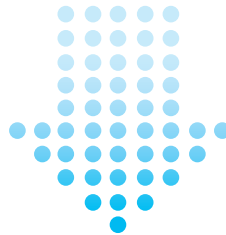

Tool Trolley Set

101 PC.



75.8
CUFT 14.65



932-009MR
(87432-5B P.37)



932-009MR-G
(87432-5B-G P.37)



932-009MR-B
(87432-5B-B P.37)



85.94
CUFT 18.05



9634-009MR
(87634-7B P.38)



9634-009MR-G
(87634-7B-G P.38)



9634-009MR-B
(87634-7B-B P.38)





Tool Trolley Contents

144 PC.



Contents No. 932-010MRD

17.50 CUFT 1.86



9-4328MR #4 P.114
84700612B



9-5575MR #4 P.115



9-1216MR01 #4 P.116



9-1709MR #4 P.117
84700612B



9-90106SR #4 P.121



9-31106MR #5 P.124
9-40103GP #5 P.124
84700612B



34423-1A P.305



Tool Trolley Set

144 PC.



73.5
CUFT 14.1



932-010MR
(87432-5B P.37)



932-010MR-G
(87432-5B-G P.37)



932-010MR-B
(87432-5B-B P.37)



83.64
CUFT 17.5



9634-010MR
(87634-7B P.38)



9634-010MR-G
(87634-7B-G P.38)



9634-010MR-B
(87634-7B-B P.38)

Tool Trolley Contents

170 PC.



Contents No. 941-101MRD

24.80 CUFT 2.54

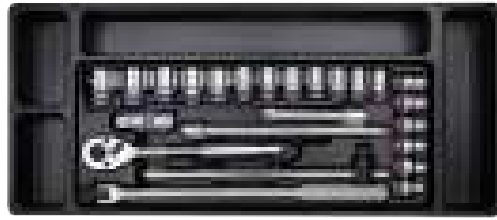
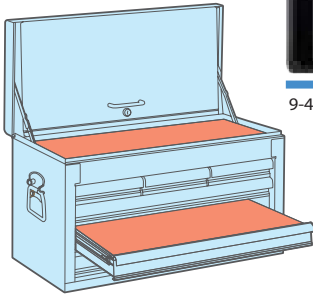

9-4026MR02 #1 P.110



9-3023MR01 #4 P.114

9-2526MR #5 P.123



9-22308PR #4 P.121

9-31106MR #5 P.124



9-4120PR #5 P.123

9-4119PR #5 P.123

9-1303MR #5 P.123

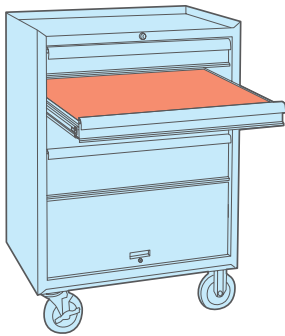

9-1711MR #4 P.118

84700612B

9-1216MR #4 P.116



9-90103RR #4 P.121

84700612B

9-20110MR #5 P.124

9-40103GP #5 P.124



9-4128FR #5 P.124



1010PR P.473

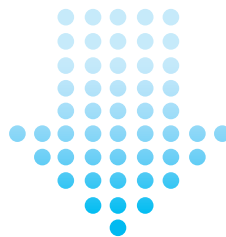

Tool Trolley Set

170 PC.



106.2
CUFT 18.31



941-101MR
(87411-6B P.48
87432-5B P.37)



125.2
CUFT 19.21



9644-101MR
(87411-6B P.48
87634-7B P.38)



Tool Trolley Contents

173 PC.



Contents No. 932-000MRD

24.70 CUFT 2.10



9-4333MR #4 P.114
84700612B



9-7540MR #4 P.115



9-1216MR01 #4 P.116



9-1711MR #4 P.118
84700612B



9-90131MR #4 P.116



9-31110MR #4 P.84
84700612B



9-22108MR #4 P.121
84700612B



9-22308PR #4 P.121



9-90103PP #4 P.121

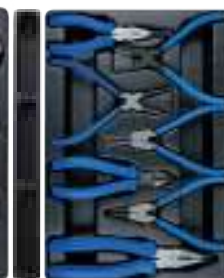

9-40207GP #4 P.120
84700612B



1006PR #4 P.473



Tool Trolley Set

173 PC.



80.70
CUFT 14.34



932-000MR
(87432-5B P.37)



932-000MR-G
(87432-5B-G P.37)



932-000MR-B
(87432-5B-B P.37)



Tool Trolley Contents

179 PC.



Contents No. 932-008MRD

20.52 CUFT 2.41



9-4522MR #4 P.113
84700612B



9-3523MR #4 P.114



9-1219MR01 #4 P.116



9-90315MR #4 P.118
84700612B



9-91120MR #4 P.119
84700612B



9-31909PR #4 P.122



9-90103PP01 #4 P.121
84700612B



9-40207GP #4 P.120



9-4120PR #5 P.123
9-4119PR #5 P.123



9-31106MR #5 P.124
9-2526MR #5 P.123
84700612B



1010PR #4 P.473



9DC23 P.597

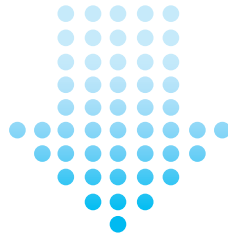

Tool Trolley Set

179 PC.



76.52
CUFT 14.65



932-008MR
(87432-5B P.37)



932-008MR-G
(87432-5B-G P.37)



932-008MR-B
(87432-5B-B P.37)



86.66
CUFT 18.05



9634-008MR
(87634-7B P.38)



9634-008MR-G
(87634-7B-G P.38)



9634-008MR-B
(87634-7B-B P.38)



Tool Trolley Contents

197 PC.



Contents No. 934-001MRD

28.70 CUFT 3.70



9-90408TQ #6 P.125



9-4516MR #4 P.113

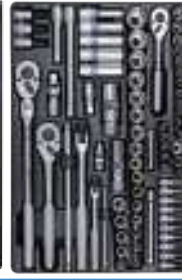

9-5575MR #4 P.115



9-1711MR #4 P.118



9-1218MR #4 P.116

84700612B

84700612B



9-22108MR #4 P.121



9-31909PR #4 P.122

84700612B



9-90310MR #4 P.122



9-90106SR #4 P.121

84700612B



9-90205GN01 #4 P.120



9-4128FR #5 P.124
9-40103GP #5 P.124

84700612B



9DC23
7962-04 P.478
P.597

42114GP P.344

2121-18 P.605

7963-04 P.478
14210212 P.376
14226512 P.376

1108MR P.326



Tool Trolley Set

197 PC.



92.7
CUFT 15.94



934-001MR
(87434-7B P.37)



934-001MR-G
(87434-7B-G P.37)



934-001MR-B
(87434-7B-B P.37)



94.84
CUFT 15.94



9634-001MR
(87634-7B P.38)



9634-001MR-G
(87634-7B-G P.38)



9634-001MR-B
(87634-7B-B P.38)



Tool Chest Set

69 PC.

901-068MR  18.80 CUFT 2.05

901-069MR  18.40 CUFT 2.05

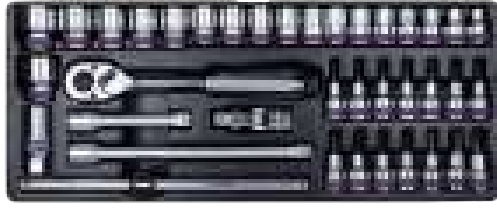

9-4338MR #11 P.130 (901-069MR use)

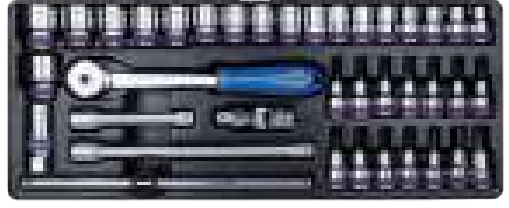

9-4338MR01 #11 P.130 (901-068MR use)



9-90121MR #12 P.130



9-90104GP #12 P.130



87401-3 P.49

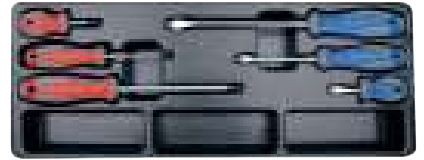

9-31006MR #12 P.131

Tool Chest Set

74 PC.

901-073MR  19.50 CUFT 2.05



9-4338MR03 #11 P.130



9-90126MR #12 P.130



9-90104GP #12 P.130



87401-3 P.49



9-31006MR #12 P.131



Tool Chest Set

219 PC.

911-000CR

50.50 CUFT 6.10

911-000CR02

50.80 CUFT 6.10



9-7069CR #1 110 (911-000CR use)

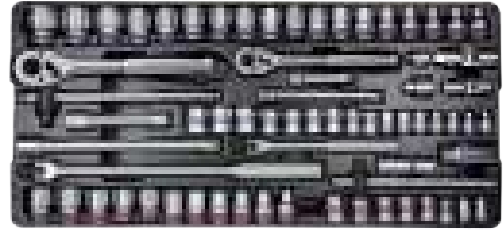

9-7069CR01 #1 P.110 (911-000CR02 use)



87411-6B P.48

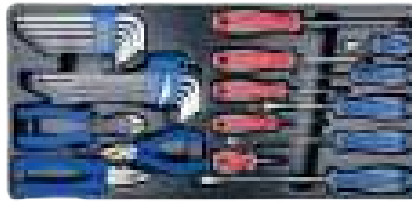

9-90129CR #3 P.112



9-90138CR #3 P.112



9-2548CR #2 P.111 (911-000CR use)



9-2548CR01 #2 P.111 (911-000CR02 use)



9-42114GP #2 P.111



9-40102GP #2 P.111



9-90128SR #3 P.111

Tool Chest Set

107 PC.

911-002CR

40.50 CUFT 5.12



87411-6B P.48



4042CR #476 x 282mm P.202



20107SR P.414
20109MR P.414



9-42144GP #4 P.120

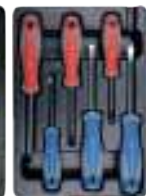

9-31106MR #5 P.124



7811-16 P.470



9-90138CR #3 112

Tool Chest Set

235 PC.

911-003CR

 46.16 CUFT 6.10

911-003CR01

 46.16 CUFT 6.10



9-7078CR #1 P.110 (911-003CR use)



9-7078CR01 #1 P.110 (911-003CR01 use)

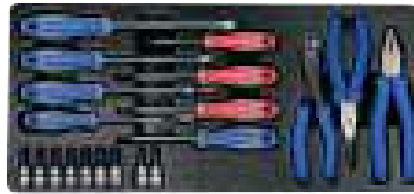

9-90220MR #3 P.112 (911-003CR use)

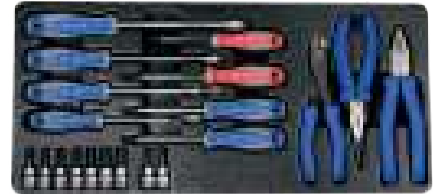

9-90220MR01 #3 P.112 (911-003CR01 use)



9-90154CR #3 P.113 (911-003CR use)



9-90154CR01 #3 P.113 (911-003CR01 use)



87411-6B P.48



9-90329CR #3 P.112



9-2548CR01 #2 P.111 (911-003CR use)



9-2548CR #2 P.111 (911-003CR01 use)



9-42114GP #2 P.111



9-40102GP #2 P.111





Tool Box Contents

62 PC.



Contents No. 902-062MRD

8.80 KUFT 1.22



9-4116FR #14 P.132

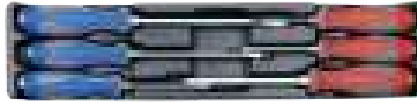

9-30206MR #14 P.132



9-1217MR #14 P.132



9-4319MR #14 P.131



9-90120MR #14 P.132

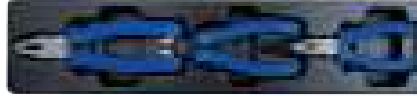

9-40203GP #14 P.132



Tool Box Set

62 PC.

14.4 KUFT 1.22



902-062MR (87402 P.50)

13.9 KUFT 1.22



9A05-062MR (87A05 P.50)



9A05-062MR-KB (87A05-KB P.50)

Tool Box Contents

63 PC.



Contents No. 902-164MRD

10.20 KUFT 1.22



9-4116FR #14 P.132



9-4219MR #14 P.131

- 1060 P.322 8, 10, 12, 13, 14, 17, 19, 21, 22, 24
- 1120MR P.414 H1.5, H2, H2.5, H3, H4, H5, H6, H8, H10
- 1421 P.376 PH1 x 80, PH2 x 38, PH3 x 150
- 1422 P.376 5.5 x 100, 6.5 x 38, 8 x 175

- 6111-07 P.353 76217-06 P.472
- 6311-06 P.354 76223-08 P.472
- 6511-10 P.356 76403-05 P.472
- 3611-08R P.342 76404-06 P.472
- 76104-05 P.471 76405-65 P.472
- 7811-16 P.470 76406-07 P.472



Tool Box Set

63 PC.

15.8 KUFT 1.22



902-164MR (87402 P.50)

15.3 KUFT 1.22



9A05-164MR (87A05 P.50)



9A05-164MR-KB (87A05-KB P.50)

Tool Box Contents

65 PC.



Contents No. 902-065MRD

9.10 CUFT 1.22



9-4116FR #14 P.132



9-4319MR #14 P.131



9-90115MR #14 P.132



9-1716MR #14 P.132

- ⊕ 1421 P.376 PH1 x 80, PH2 x 38, PH3 x 150
- ⊖ 1422 P.376 5.5 x 100, 6.5 x 38, 8 x 175

- 6111-07 P.353
- 6311-06 P.354
- 6511-10 P.356
- 3611-08P P.342
- 76104-05 P.471
- 76217-06 P.472
- 76223-08 P.472
- 76403-05 P.472
- 76404-06 P.472
- 76405-65 P.472
- 76406-07 P.472
- 7811-16 P.470



Tool Box Set

65 PC.

14.7 CUFT 1.22



902-065MR
(87402 P.50)

14.2 CUFT 1.22



9A05-065MR
(87A05 P.50)



9A05-065MR-KB
(87A05-KB P.50)

Tool Box Contents

68 PC.



Contents No. 902-068MRD

10.30 CUFT 1.22



9-4116FR #14 P.132



9-4319MR01 #14 P.131

- 1060 P.322 8, 10, 11, 12, 13, 14, 15, 16, 17, 18, 19, 21, 22, 24
- 1120MR P.414 H1.5, H2, H2.5, H3, H4, H5, H6, H8, H10
- ⊕ 1421 P.376 PH1 x 80, PH2 x 38, PH3 x 150
- ⊖ 1422 P.376 5.5 x 100, 6.5 x 38, 8 x 175

- 6111-07 P.353
- 6311-06 P.354
- 6511-10 P.356
- 3611-12P P.342
- 76104-05 P.471
- 7911-12 P.494
- 76217-06 P.472
- 76223-08 P.472
- 76403-05 P.472
- 76404-06 P.472
- 76405-65 P.472
- 76406-07 P.472
- 7821-30 P.470



Tool Box Set

68 PC.

15.9 CUFT 1.22



902-068MR
(87402 P.50)

15.4 CUFT 1.22



9A05-068MR
(87A05 P.50)



9A05-068MR-KB
(87A05-KB P.50)



Tool Box Contents

81 PC.



Contents No. 902-084MRD01

13.60 CUFT 1.22



9-4116FR03 #14 P.132



9-4219MR07 #14 P.131



1215MR P.323

- 4230M P.179 16, 17, 18, 19, 20, 21, 22, 24, 25, 26
- 1421 P.376 PH1 x 100, PH2 x 150, PH3 x 150
- 1422 P.376 6.5 x 100, 6.5 x 150, 8 x 150
- 6231-07 P.353 6311-06 P.354
- 6463-08C P.355 6516-10C P.355

- 6031-07R P.360 76104-05 P.471
- 3611-08R P.342 76105-06 P.471
- 3611-12R P.342 76213-04 P.472
- 20218MR P.412 76215-05 P.472
- 7851-16 P.471 76220-07 P.472
- 7811-16 P.470 76306-05 P.471
- 76403-05 P.472
- 76404-06 P.472



Tool Box Set

81 PC.

19.24 CUFT 1.22



902-084MR01 (87402 P.50)

18.74 CUFT 1.22



9A05-084MR01 (87A05 P.50)



9A05-084MR01-KB (87A05-KB P.50)

Tool Box Contents

84 PC.



Contents No. 902-084SRD

15.90 CUFT 1.22



9-4116FR03 #14 P.132



9-4219SR08 #14 P.131



1216SR P.323

- 4230S P.179 1/2, 9/16, 5/8, 11/16, 3/4, 13/16, 7/8, 15/16, 1, 1-1/16, 1-1/8, 1-1/4
- 1421 P.376 PH1 x 100, PH2 x 150, PH3 x 150
- 1422 P.376 6.5 x 100, 6.5 x 150, 8 x 150
- 6231-07 P.353 6311-06 P.354
- 6463-08C P.355 6516-10C P.355
- 20107SR P.414 6031-07R P.360

- 3611-08R P.342 76104-05 P.471
- 3611-12R P.342 76105-06 P.471
- 7811-16 P.470 76213-04 P.472
- 7851-16 P.471 76215-05 P.472
- 76220-07 P.472
- 76306-05 P.471
- 76403-05 P.472
- 76404-06 P.472



Tool Box Set

84 PC.

21.55 CUFT 1.22



902-084SR (87402 P.50)

21.0 CUFT 1.22



9A05-084SR (87A05 P.50)



9A05-084SR-KB (87A05-KB P.50)

Tool Box Contents

88 PC.



Contents No. 902-089MRD01

13.90 CUFT 1.22



9-4116FR #14 P.132



9-4319MR01 #14 P.131



1812MR P.341

- | | | | |
|--------------|--|----------------|---------------------|
| 1060 P.322 | 6, 7, 8, 9, 10, 11, 12, 13, 14, 15, 16, 17, 18, 19, 20, 21, 22, 24 | 1421 P.367 | PH2 x 38, PH3 x 150 |
| 1900 P.326 | 6 x 7, 8 x 10, 11 x 13, 12 x 13, 17x19, 22 x 24 | 1422 P.367 | 3 x 75, 5 x 100 |
| 1120MR P.414 | H1.5, H2, H2.5, H3, H4, H5, H6, H8, H10 | 6111-07 P.353 | 3611-08R P.342 |
| 1147R P.416 | T10H, T15H, T20H, T25H, T27H, T30H, T40H | 6311-06 P.354 | 7911-12 P.494 |
| | | 6516-10C P.355 | 7821-80 P.470 |

Tool Box Set

88 PC.



19.5 CUFT 1.22



902-089MR01 (87402 P.50)

19.0 CUFT 1.22



9A05-089MR01 (87A05 P.50)



9A05-089MR01-KB (87A05-KB P.50)

Tool Box Contents

103 PC.



Contents No. 902-103MRD

19.20 CUFT 1.22



9-4116FR #14 P.132



9-4319MR01 #14 P.131



1812MR P.341

- | | | | |
|--------------|--|-----------------|----------------|
| 1060 P.322 | 8, 9, 10, 11, 12, 13, 14, 15, 16, 17, 18, 19, 21, 22, 23, 24, 27, 30, 32 | 6111-07 P.353 | 7911-12 P.494 |
| 1120MR P.414 | H1.5, H2, H2.5, H3, H4, H5, H6, H8, H10 | 6311-06 P.354 | 7821-80 P.470 |
| 1147R P.416 | T10H, T15H, T20H, T25H, T27H, T30H, T40H | 6516-10C P.355 | 76220-07 P.472 |
| 1421 P.376 | PH0 x 60, PH1 x 100, PH2 x 100, PH3 x 150 | 6231-08 P.353 | 76226-12 P.472 |
| 1422 P.376 | 3 x 75, 4 x 100, 5 x 75, 5.5 x 125, 6.5 x 150, 8 x 175 | 6431-10 P.355 | 76402-45 P.472 |
| | | 6011-10R P.360 | 76403-05 P.472 |
| | | 3611-12R P.342 | 76404-06 P.472 |
| | | 79093-03C P.482 | 76405-65 P.472 |
| | | | 76406-07 P.472 |
| | | | 76408-08 P.472 |
| | | | 76412-09 P.472 |
| | | | 76414-10 P.472 |

Tool Box Set

103 PC.



24.8 CUFT 1.22



902-103MR (87402 P.50)

24.3 CUFT 1.22



9A05-103MR (87A05 P.50)



9A05-103MR-KB (87A05-KB P.50)



Tool Box Contents

109 PC.



Contents No. 902-109MRD

19.40 CUFT 1.22



9-4116FR #14 P.132



9-4319MR01 #14 P.131



1812MR P.341



1306MR P.332

- | | | | |
|--------------|--|-----------------|----------------|
| 1060 P.322 | 8, 9, 10, 11, 12, 13, 14, 15, 16, 17, 18, 19, 21, 22, 23, 24, 27, 30, 32 | 6111-07 P.353 | 7911-12 P.494 |
| 1120MR P.414 | H1.5, H2, H2.5, H3, H4, H5, H6, H8, H10 | 6311-06 P.354 | 7811-16 P.470 |
| 1147R P.416 | T10H, T15H, T20H, T25H, T27H, T30H, T40H | 6516-10C P.355 | 76220-07 P.472 |
| 1421 P.376 | PH0 x 60, PH1 x 100, PH2 x 100, PH3 x 150 | 6232-08 P.353 | 76226-12 P.472 |
| 1422 P.376 | 3 x 75, 4 x 100, 5 x 75, 5.5 x 125, 6.5 x 150, 8 x 175 | 6431-10 P.355 | 76402-45 P.472 |
| | | 6011-10R P.360 | 76403-05 P.472 |
| | | 3611-12R P.342 | 76404-06 P.472 |
| | | 79093-05C P.482 | 76405-65 P.472 |
| | | | 76406-07 P.472 |
| | | | 76408-08 P.472 |
| | | | 76412-09 P.472 |
| | | | 76414-10 P.472 |

Tool Box Set

109 PC.



24.99 CUFT 1.22



902-109MR
(87402 P.50)

24.5 CUFT 1.22



9A05-109MR
(87A05 P.50)



9A05-109MR-KB
(87A05-KB P.50)

Tool Box Contents

132 PC.



Contents No. 902-132CRD

24.50 CUFT 1.51



9-4116FR #14 P.132



9-4319MR01 #14 P.131



1812MR P.341



1226MR P.323



1005GQ P.495



30617MR P.432



20208MR01
20208SR01
P.413



11205SQ
P.489

- | | | | |
|------------|--|----------------|-----------------|
| 1421 P.376 | PH0 x 60, PH1 x 100, PH2 x 100, PH3 x 150 | 6111-07 P.353 | 7911-12 P.494 |
| 1422 P.376 | 3 x 75, 4 x 100, 5 x 75, 5.5 x 125, 6.5 x 150, 8 x 175 | 6311-06 P.354 | 7811-12 P.470 |
| | | 6516-10C P.355 | 76104-05 P.471 |
| | | 6231-07 P.353 | 76220-07 P.472 |
| | | 6721-10 P.465 | 6011-10R P.360 |
| | | 6711-06 P.355 | 2121-18 P.605 |
| | | 3611-08P P.342 | 7971-07 P.458 |
| | | 3611-12P P.342 | 79093-03C P.482 |
| | | 20419PR P.417 | |

Tool Box Set

132 PC.



30.1 CUFT 2.73



902-132CR
(87402 P.50)

29.1 CUFT 2.92



9A05-132CR
(87A05 P.50)



9A05-132CR-KB
(87A05-KB P.50)

Tool Box Contents

77
PC.



Contents No. 908-077CRD

19.80 CUFT 0.99



9-4029CR #15 P.133



9-90111MR #15 P.133



9-4156PR #15 P.133



9-30206MR #14 P.132

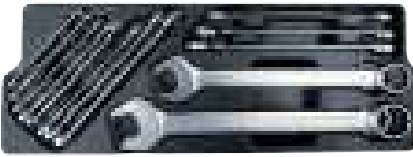

9-1215MR03 #16 P.133

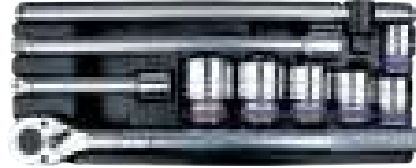

9-6010MR #16 P.133

Tool Box Set

77
PC.



26.52
CUFT 2.29



908-077CR
(87408 P.50)





Tool Box Contents

25 PC.



Contents No. 41026MRD

3.96 CUFT 0.78

- 4330MR P.178 10, 11, 12, 13, 14, 15, 16, 17, 18, 19, 20, 21, 22, 23, 24, 27, 30, 32
- 463021RC P.182
- 4791R P.192
- 4452-15FR P.190
- 4768-10F P.186
- 4572-12 P.191
- 4251-05R P.190
- 4251-10R P.190



Tool Box Set

25 PC.

5.7 CUFT 0.78

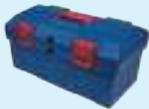

41026MR (87407 P.50)

Tool Box Contents

25 PC.



Contents No. 41526MRD

3.96 CUFT 0.78

- 4335MR P.178 10, 11, 12, 13, 14, 15, 16, 17, 18, 19, 20, 21, 22, 23, 24, 27, 30, 32
- 463521RC P.182
- 4791R P.192
- 4452-15FR P.190
- 4768-10F P.186
- 4572-12 P.191
- 4251-05R P.190
- 4251-10R P.190



Tool Box Set

25 PC.

5.7 CUFT 0.78



41526MR (87407 P.50)









Tool Box Contents

17 PC.





Contents No. 41517MRVD 2.26 CUFT 0.91

-   4335MR [P.178](#) 10, 11, 13, 14, 15, 16, 17, 18, 19, 21, 22, 24
-  4771-10GR [P.186](#)
-  4791R [P.192](#)
-  4251-05R [P.190](#)
-  3611-08R [P.342](#)
-  6111-06 [P.353](#)



Tool Box Set

17 PC.















 4.26  **41517MRV**
CUFT 0.91 (87A08 P.50)

Tool Box Contents

42 PC.





Contents No. 41542MRVD 4.65 CUFT 0.91

-   4335MR [P.178](#) 10, 11, 13, 14, 15, 16, 17, 18, 19, 21, 22, 24
-   1421 [P.376](#) PH0 x 60, PH1 x 80, PH2 x 100
-   1422 [P.376](#) 3 x 75, 5.5 x 100, 6.5 x 150
-   1130MR [P.414](#) H2.5, H3, H4, H5, H6, H8, H10
-  1062 [P.320](#) 8, 9, 10, 11, 12, 13, 14, 17, 18, 19, 22, 24
-  4251-05R [P.190](#)
-  3611-08R [P.342](#)
-  6111-06 [P.353](#)
-  4771-10GR [P.186](#)
-  4791R [P.192](#)



Tool Box Set

42 PC.

 6.65  **41542MRV**
CUFT 0.91 (87A08 P.50)

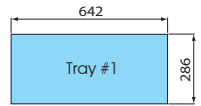

Tool Set Content

9-4526MR

9-4026MR02 Tray category #1 (642 x 286mm)



9-4526MR



9-4026MR02

24 PC.

KT NO.

Contents



4.6



1 / 5

9-4526MR	4335MR	10, 11, 12, 13, 14, 15, 16, 17, 18, 19, 20, 21, 22, 23, 24, 27, 30, 32	463521RC	4768-10F	4572-12	4251-05R 4251-10R
9-4026MR02	4330MR		463021RC	4768-10P	4452-15FR	

9-7069CR

9-7069CR01 Tray category #1 (642 x 286mm)



9-7069CR



9-7069CR01

70 PC.



7911-12

KT NO.

Contents



8.8



1 / 2

9-7069CR	3779-08G 4779-10GR	3330M 6, 7, 8, 9, 10, 11, 12, 13, 14, 15, 16, 17, 19, 20, 21, 22 3330S 3/8, 7/16, 1/2, 9/16, 5/8, 11/16, 3/4, 13/16	463521RC	463516RC	3571-08	
9-7069CR01	3769-08P 4768-10P	4330MR 10, 11, 12, 13, 14, 15, 16, 17, 18, 19, 20, 21, 22, 23, 24, 27, 30, 32 4330SR 3/8, 7/16, 1/2, 9/16, 5/8, 11/16, 3/4, 13/16, 7/8, 15/16, 1	3452-08F	4452-15FR	4251-05R 4251-10R	7911-12
			4572-10	3221-03 3221-06		3792 4791R 3812 4813

9-7078CR

9-7078CR01 Tray category #1 (642 x 286mm)



9-7078CR



9-7078CR01

78 PC.

KT NO.

Contents



8.67



1 / 2

9-7078CR	3769-08P 4768-10P	3330M 8, 9, 10, 11, 12, 13, 14, 15, 16, 17, 18, 19, 20, 21, 22 3330S 3/8, 7/16, 1/2, 9/16, 5/8, 11/16, 3/4, 13/16	3235M 10, 12, 13, 14, 15, 16, 17, 18, 19, 22	363516	
9-7078CR01	3779-08G 4779-10GR	4330MR 10, 11, 12, 13, 14, 15, 16, 17, 18, 19, 20, 21, 22, 23, 24, 25, 27, 28, 30, 32 4330SR 3/8, 7/16, 1/2, 9/16, 5/8, 11/16, 3/4, 13/16, 7/8, 15/16, 1, 1-1/8, 1-1/4	4462-18F	3221-03 3221-10	4251-05R 4251-10R
			3792	4791R	3812 4813

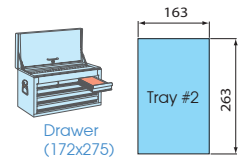

Tool Set Content

9-2548CR

9-2548CR01 Tray category #2 (263 x 163mm)

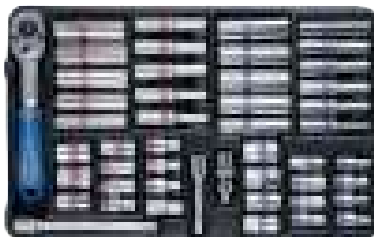

48 PC.

9-2548CR

9-2548CR01

KT NO.	Contents		kg 1.28	1 / 10
9-2548CR	2779-55G	2235M 4, 5, 5.5, 6, 7, 8, 9, 10, 11, 12, 13 2235S 5/32, 3/16, 7/32, 1/4, 9/32, 5/16, 11/32, 3/8, 7/16, 1/2	2335M 4, 4.5, 5, 5.5, 6, 7, 8, 9, 10, 11, 12, 13 2335S 5/32, 3/16, 7/32, 1/4, 9/32, 5/16, 11/32, 3/8, 7/16, 1/2	
9-2548CR01	2769-55P	2792 2813 2221-02 2221-04		

9-40102GP

9-42114GP Tray category #2 (263 x 163mm)



2 PC.



4 PC.

Contents	kg 1.0	1 / 10
6011-10R	6511-10	

Contents	kg 0.6	1 / 10
68HS-07	68SS-07	
68HB-07	68SB-07	

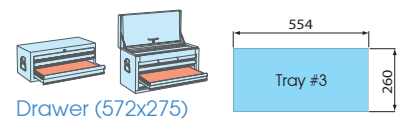

9-90128SR

Tray category #3 (554 x 260mm)

Contents	kg 4.8	1 / 4
5060	1/4, 5/16, 3/8, 7/16, 1/2, 9/16, 5/8, 11/16, 3/4, 13/16, 7/8, 1	
5970	1/4 x 5/16, 3/8 x 7/16, 1/2 x 9/16, 5/8 x 11/16, 3/4 x 7/8, 15/16 x 1, 1-1/16 x 1-1/8	
76105-06	7811-16	
76215-05	76404-06	
76217-06	76406-07	
76220-07	76408-08	
76224-10		



28 PC.



Tool Set Content

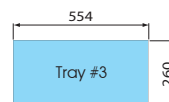
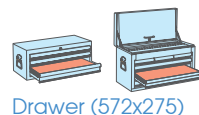

9-90138CR

Tray category #3 (554 x 260mm)

Contents

4.8 kg 1 / 4

	1060	6, 7, 8, 9, 10, 11, 12, 13, 14, 15, 16, 17, 19, 20, 21
	1900	8 x 9, 10 x 11, 12 x 13, 14 x 15, 18 x 19
	1970	6 x 7, 8 x 9, 10 x 11, 12 x 13, 14 x 15, 16 x 17, 18 x 19
	1930	10 x 11, 12 x 14, 14 x 17
	5900	1/4 x 5/16, 3/8 x 7/16, 7/16 x 1/2, 9/16 x 5/8, 11/16 x 3/4, 13/16 x 7/8
	3611P	8, 12



38 PC.

9-90329CR

Tray category #3 (554 x 260mm)

Contents

3.37 kg 1 / 4

	1060	6, 7, 8, 10, 11, 12, 13, 14, 15, 16, 17, 18, 19, 21
	5060	7/16, 1/2, 9/16, 5/8, 11/16, 3/4
	10D0	10, 12, 13, 14, 17, 18, 19
	3611R	6, 8



29 PC.

9-90129CR

Tray category #3 (554 x 260mm)

Contents

2.5 kg 1 / 4

	1421	PH0 x 60, PH1 x 80, PH2 x 38, PH2 x 100, PH3 x 150
	1422	3 x 75, 6.5 x 38, 6.5 x 100, 6.5 x 150, 8 x 175
	1130SR	3/32, 1/8, 5/32, 3/16, 1/4, 5/16, 3/8
	1120MR	H1.5, H2, H2.5, H3, H4, H5, H6, H8, H10
	6111-07	6231-07
	6311-06	

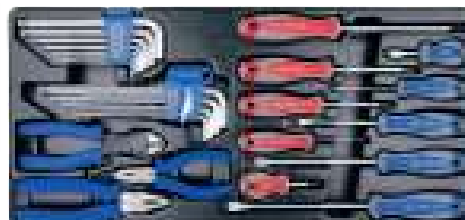

29 PC.

9-90220MR



9-90220MR

9-90220MR01

Tray category #3 (554 x 260mm)

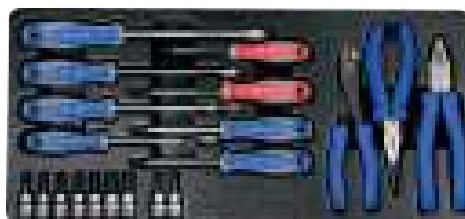

9-90220MR01

20 PC.

KT NO.

Contents

2.51 kg 1 / 4

9-90220MR		14280204		3025	H3, H4, H5, H6, H8, H10, H12		1421	PH1x80, PH2x100
		14240206		3023	T30, T40		1422	4x100, 5.5x125, 6.5x150, 8x175
9-90220MR01		14232004		6111-08		6232-08		6311-08
		14232504						



Tool Set Content

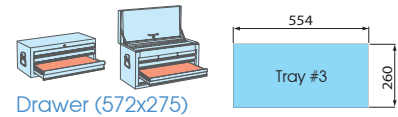

9-90154CR

9-90154CR01 Tray category #3 (554 x 260mm)

KT NO.	PC.	Contents	kg 2.86	1 / 4
9-90154CR	54	1032CQ01	<ul style="list-style-type: none"> 1130MR H2.5, H3, H4, H5, H6, H8, H10 1130SR 3/32, 1/8, 5/32, 3/16, 1/4, 5/16, 3/8 	
9-90154CR01	53	1032CQ	<ul style="list-style-type: none"> 7811-16 74030 76717-05 761 Ø 4 x 120 764 Ø 3 x 125, Ø 4 x 150, Ø 5 x 165 	

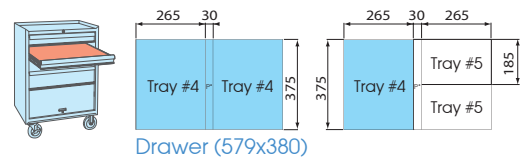
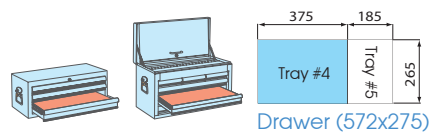

9-4516MR

Tray category #4 (375 x 265mm)

Contents	kg 3.12	1 / 10
4335MR 8, 10, 11, 12, 13, 14, 17, 19, 21, 23, 24		
4791R 4768-10F 4452-15FR		
4251-05R 4251-10R		



16 PC.

9-4522MR

Tray category #4 (375 x 265mm)

Contents	kg 2.96	1 / 10
4335MR 8, 10, 11, 12, 13, 14, 15, 16, 17, 18, 19, 20, 21, 22, 24		
463521RC 463516RC 4791R		
4768-10F 4251-03R, 4251-05R, 4251-10R		



22 PC.

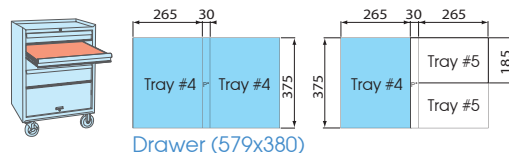
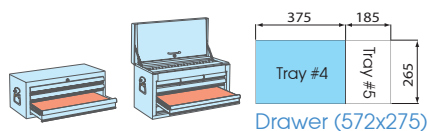

Tool Set Content

9-3523MR

9-3023MR01 Tray category #4 (375 x 265mm)



9-3523MR



9-3023MR01

22
PC.

KT NO.	Contents	kg 1.38	1 / 10
9-3523MR	3335M 6, 7, 8, 9, 10, 11, 12, 13, 14, 15, 16, 17, 19, 20, 21, 22	3769-08F 3221-03 3221-06 3452-08F	
9-3023MR01	3330M	3769-08P 3792 3571-08	

9-4328MR Tray category #4 (375 x 265mm)

Contents	kg 4.6	1 / 6
4335MR 8, 9, 10, 11, 12, 13, 14, 15, 16, 17, 18, 19, 20, 21, 22, 23, 24, 27, 29, 32		
4027 T55H, T60H		
4791R 4768-10F 4452-15FR		
4572-10 4251-05R 4251-10R		



28
PC.

9-4333MR

9-4333MR03 Tray category #4 (375 x 265mm)



9-4333MR



9-4333MR03

33
PC.

KT NO.	Contents	kg 5.4	1 / 6
9-4333MR	4755-10G 4335MR 8, 9, 10, 11, 12, 13, 14, 15, 16, 17, 18, 19, 20, 21, 22, 23, 24, 25, 26, 27, 28, 29, 30, 32		
9-4333MR03	4779-10GR 463521RC 463516RC 4791R 4572-12 4452-15FR 4251-03R 4251-05R 4251-10R		

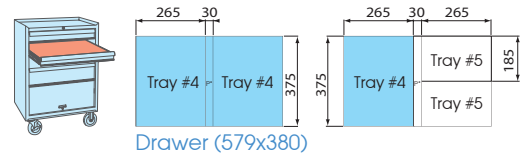
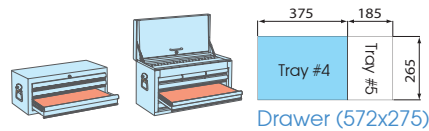

Tool Set Content

9-5575MR Tray category #4 (375 x 265mm)

Contents		4.15 kg	1 / 6
	2335M	4, 4.5, 5, 5.5, 6, 7, 8, 9, 10, 11, 12, 13	
	2335S	1/4, 3/8, 1/2	
	3235M	8, 10, 12, 14, 17	
	3335M	6, 7, 8, 9, 10, 11, 12, 13, 14, 15, 16, 17, 18, 19, 21, 22	
	2375M	E4, E5, E6, E7, E8	
	3375M	E10, E12, E14, E16, E18	
	2037	T10H, T15H, T20H, T25H, T27H, T30H	
	2033	T20, T25, T30, T40	
	3027	T40H, T45H, T50H	



75 PC.

Contents		
	366516	
	366521	
	3221-16	
	2769-55F	
	3769-08F	
	3781-11F	
	2221-02	
	2221-04	
	3221-03	
	3221-06	
	2571-45	
	2452-05F	
	3452-08F	
	3571-08	
	2792	
	3792	

9-7537MR Tray category #4 (375 x 265mm)

Contents		2.28 kg	1 / 6
	2335M	4, 4.5, 5, 5.5, 6, 7, 8, 9, 10, 11, 12, 13	
	4023	T20, T25, T27, T30, T40, T45, T50, T55, T60	
	4025	H3, H4, H5, H6, H7, H8, H10, H12, H14	
	2779-55G		
	2571-45		
	2792		
	2452-05F		
	2221-02		
	2221-04		
	2141		



37 PC.

9-7540MR Tray category #4 (375 x 265mm)

Contents		3.50 kg	1 / 5
	2335M	4, 4.5, 5, 5.5, 6, 7, 8, 9, 10, 11, 12, 13	
	2375M	E4, E5, E6, E7, E8	
	4375M	E10, E12, E14, E16, E18, E20	
	4435M	10, 11, 12, 13, 14, 17, 19, 21, 22, 24	
	2792		
	2755-55G		
	2571-45		
	2221-02		
	2221-04		
	2177DF		
	2452-05F		



40 PC.

9-93523MR Tray category #4 (375 x 265mm)

Contents		2.63 kg	1 / 6
	3335M	6, 7, 8, 9, 10, 11, 12, 13, 14, 15, 16, 17, 19, 20, 21, 22	
	1120MR	H1.5, H2, H2.5, H3, H4, H5, H6, H8, H10	
	3792		
	3769-08F		
	3452-08F		
	3571-08		
	3221-03		
	3221-06		



31 PC.

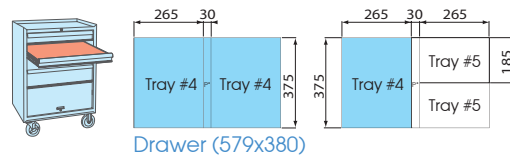
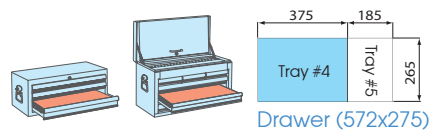

Tool Set Content

9-90131MR

Tray category #4 (375 x 265mm)

Contents

3.1 kg / 1 / 10

	4033	T20, T25, T27, T30, T40, T45, T50, T55, T60
	4035	H4, H5, H6, H7, H8, H10, H12, H14, H17
	1120MR	H1.5, H2, H2.5, H3, H4, H5, H6, H8, H10
	1930	10 x 11, 12 x 14, 14 x 17
	3204 (Ø 60 ~ 140)	



31 PC.

9-1205MR

Tray category #4 (375 x 265mm)

Contents

2.70 kg / 1 / 6

	1060	27, 28, 29, 30, 32
--	------	--------------------



5 PC.

9-1216MR

9-1216MR01

9-1216MR03

Tray category #4 (375 x 265mm)

KT NO.

Contents

3.20 kg / 1 / 6

9-1216MR		6, 8, 10, 12, 13, 14, 16, 17, 19, 21, 22, 24, 26, 27, 29, 32
9-1216MR01	1060	6, 8, 10, 11, 13, 14, 16, 17, 18, 19, 21, 22, 24, 27, 30, 32
9-1216MR03		8, 10, 11, 12, 13, 14, 15, 17, 18, 19, 21, 22, 24, 27, 30, 32



16 PC.

9-1219MR01

Tray category #4 (375 x 265mm)

Contents

2.25 kg / 1 / 6

	1060	6, 7, 8, 9, 10, 11, 12, 13, 14, 15, 16, 17, 18, 19, 20, 21, 22, 23, 24
--	------	--



19 PC.

9-1218MR

Tray category #4 (375 x 265mm)

Contents

2.12 kg / 1 / 6

	1060	6, 7, 8, 10, 11, 12, 13, 14, 15, 16, 17, 18, 19, 21, 22, 24
	1930	8 x 10, 9 x 11



18 PC.

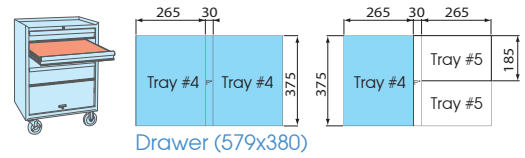
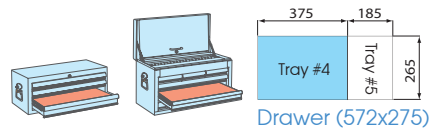

Tool Set Content

9-1282MR Tray category #4 (375 x 265mm)

Contents		1.05 kg	1 / 10
	10D0 8, 9, 10, 11, 12, 13, 14, 15, 16, 17, 18, 19		



12 PC.

9-1272MR Tray category #4 (375 x 265mm)

Contents		1.45 kg	1 / 5
	1067 6, 7, 8, 9, 10, 11, 12, 13, 14, 17, 19, 22		



12 PC.

9-1608MR Tray category #4 (375 x 265mm)

Contents		1.5 kg	1 / 6
	1960 6 x 7, 8 x 9, 10 x 11, 12 x 13, 14 x 15, 16 x 17, 18 x 19, 20 x 22		



8 PC.

9-1609MR Tray category #4 (375 x 265mm)

Contents		1.93 kg	1 / 6
	1960 8 x 9, 10 x 12, 11 x 13, 12 x 14, 14 x 17, 17 x 19, 19 x 21, 22 x 24, 23 x 26		



9 PC.

9-1709MR Tray category #4 (375 x 265mm)

Contents		2.18 kg	1 / 6
	1970 8 x 9, 10 x 12, 11 x 13, 12 x 14, 14 x 17, 17 x 19, 19 x 21, 22 x 24, 23 x 26		



9 PC.

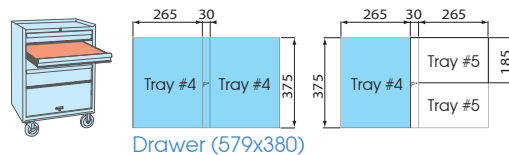
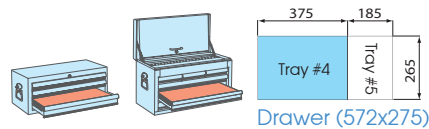

Tool Set Content

9-1711MR

Tray category #4 (375 x 265mm)

Contents

2.80 1 / 6



1970

6 x 7, 8 x 9, 10 x 11, 12 x 13,
14 x 15, 16 x 17, 18 x 19, 20 x 22,
21 x 23, 24 x 27, 30 x 32



11
PC.

9-90315MR

Tray category #4 (375 x 265mm)

Contents

2.6 1 / 6



1900

8 x 10, 10 x 12, 12 x 14, 14 x 17,
17 x 19, 21 x 23, 22 x 24



1970

8 x 10, 10 x 12, 12 x 14, 14 x 17,
17 x 19, 21 x 23, 22 x 24



79093-05C



15
PC.

9-1812MR

9-1912MR

Tray category #4 (375 x 265mm)

KT NO.

Contents

3.69 1 / 6

9-1812MR



1080

8, 10, 11, 12, 13, 14, 16, 17,
18, 19, 22, 24

9-1912MR



1081

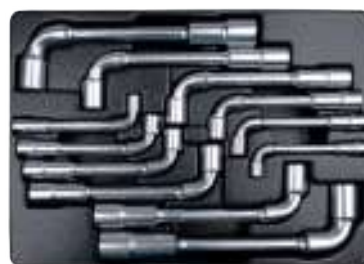

12
PC.

9-1838MR

Tray category #4 (375 x 265mm)

Contents

2.57 1 / 6



1084

8, 10, 11, 12, 13, 15, 17, 19

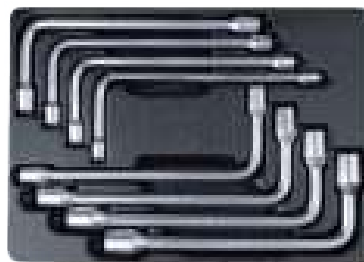

8
PC.

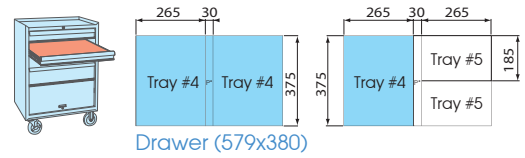
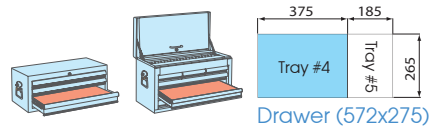

Tool Set Content

9-1C08MR Tray category #4 (375 x 265mm)

Contents		0.91	1 / 10
19C0	6 x 7, 8 x 9, 10 x 11, 12 x 13, 14 x 15, 16 x 17, 18 x 19, 20 x 22		



8
PC.

9-10115MR 9-102A15MR Tray category #4 (375 x 265mm)

KT NO.	Contents	1.9	1 / 10
9-10115MR	3731M	8, 9, 10, 11, 12, 13, 14, 15, 16, 17, 19, 22	373202R
9-102A15MR	373AM		373203R 373204R



15
PC.

9-12120MR Tray category #4 (375 x 265mm)

Contents		1.27	1 / 6
3731M	8, 10, 12, 13, 14, 15, 17, 19		
373204R	373203R		



10
PC.

9-90109MN Tray category #4 (375 x 265mm)

Contents		2.28	1 / 6
1970	8 x 10, 10 x 12, 11 x 13, 12 x 14, 14 x 17, 17 x 19		
6011-10N	3611-12R		



8
PC.

9-91120MR Tray category #4 (375 x 265mm)

Contents		2.40	1 / 6
1120MR	H1.5, H2, H2.5, H3, H4, H5, H6, H8, H10		
1930	8 x 10, 10 x 12, 11 x 13, 14 x 17		
3731M	8, 10, 12, 13, 14		
6011-10N	3611-12R		



20
PC.

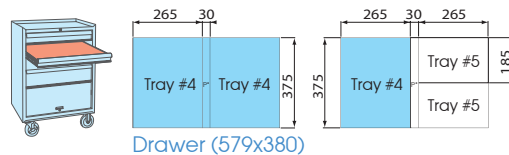
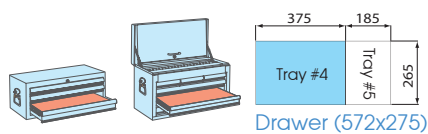

Tool Set Content

9-40207GP

9-40207GP01 Tray category #4 (375 x 265mm)



9-40207GP



9-40207GP01

7 PC.

KT NO.	Contents	kg	Box
9-40207GP	6111-08 6211-06 6311-06 68HS-07 68HB-07 68SS-07 68SB-07	1.5	1 / 10
9-40207GP01	6463-08C 6211-06 6311-06 67HS-07 67HB-07 67SS-07 67SB-07		1 / 6

9-40604GP Tray category #4 (375 x 265mm)

Contents	kg	Box
6116-07A 6216-06A 6318-08A 6516-10A	1.98	1 / 6



4 PC.

9-42144GP Tray category #4 (375 x 265mm)

Contents	kg	Box
6011-10N 6111-08 6211-06 6311-06	1.63	1 / 8



4 PC.

9-90205GN

9-90205GN01 Tray category #4 (375 x 265mm)



9-90205GN



9-90205GN01

5 PC.

Contents	kg	Box
9-90205GN 6313-06 6011-10N 6111-07 6463-08C 74410	1.98	1 / 6
9-90205GN01 6311-06		

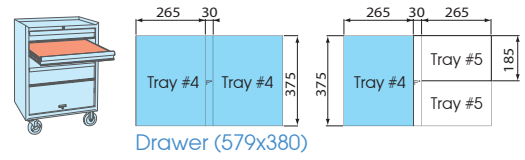
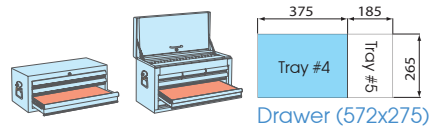

Tool Set Content

9-90103PP **9-90103PP01** **9-90103PP02** Tray category #4 (375 x 265mm)



9-90103PP



9-90103PP01



9-90103PP02

3
PC.

KT NO.	Contents	⚖️	📦
9-90103PP			
9-90103PP01	3611-12P 6511-10	2.30	1 / 5
9-90103PP02		2.51	1 / 10

9-90103RR Tray category #4 (375 x 265mm)

Contents ⚖️ 2.3 📦 1 / 5

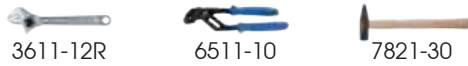

3
PC.

9-90106SR Tray category #4 (375 x 265mm)

Contents ⚖️ 2.05 📦 1 / 4



6
PC.

9-22108MR Tray category #4 (375 x 265mm)

Contents ⚖️ 1.10 📦 1 / 10

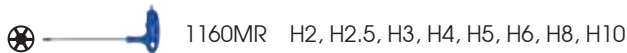

8
PC.

9-22308TR Tray category #4 (375 x 265mm)

Contents ⚖️ 1.10 📦 1 / 10



8
PC.

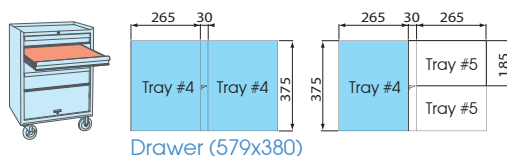
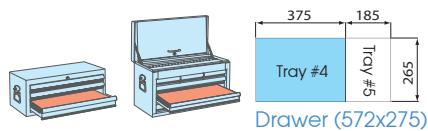

Tool Set Content

9-30110CR Tray category #4 (375 x 265mm)

Contents		1.4 kg	1 / 6
⊖	1450	6, 7, 8, 9, 10, 11, 12, 13	
⊖	5450	1/4, 5/16	



10 PC.

9-31110MR Tray category #4 (375 x 265mm)

Contents		1.0 kg	1 / 10
⊕	1421	PH1 x 80, PH2 x 38, PH2 x 100, PH3 x 150	
⊖	1422	3 x 75, 4 x 100, 5.5 x 125, 6.5 x 38, 6.5 x 150, 8 x 175	



10 PC.

9-31909PR Tray category #4 (375 x 265mm)

Contents		0.65 kg	1 / 6
⊗	1427	T8H x 75, T9H x 75, T10H x 75, T15H x 75, T20H x 100, T25H x 100, T27H x 100, T30H x 125, T40H x 150	



9 PC.

9-90310MR Tray category #4 (375 x 265mm)

Contents		1.08 kg	1 / 6
⊕	1411	PH1 x 100, PH2 x 100, PH3 x 150	
⊖	1412	5.5 x 100, 6.5 x 100, 8.0 x 150	
	76220-07	9CJ2120	14324003
			24110214



10 PC.

9-34128FR Tray category #4 (375 x 265mm)

Contents		1.98 kg	1 / 6
⊕	1836P	PH2, PH3	
⊖	1836S	9, 11	
⊕	1880P	PH2, PH3	
⊖	1880S	8, 10	
	1930	8 x 10, 11 x 13, 12 x 14	
	4112	414810S	3204



14 PC.

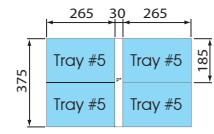
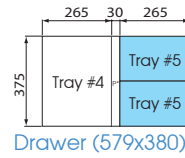

Tool Set Content

9-2526MR Tray category #5 (265 x 185mm)

Contents		0.90 kg	1 / 10
2335M	4, 4.5, 5, 5.5, 6, 7, 8, 9, 10, 11, 13		
2235M	4, 5, 5.5, 6, 7, 8, 9, 10, 11, 13		
2779-55G	2813		
2221-02			
2221-04	2792		



26 PC.

9-4119PR Tray category #5 (265 x 185mm)

Contents		1.10 kg	1 / 10
4033	T20, T25, T27, T30, T40, T45, T50, T55, T60		



9 PC.

9-4120PR Tray category #5 (265 x 185mm)

Contents		1.30 kg	1 / 10
4035	H4, H5, H6, H7, H8, H10, H12, H14, H17		



9 PC.

9-91026PR Tray category #5 (265 x 185mm)

Contents		1.30 kg	1 / 10
1143R	T10, T15, T20, T25, T27, T30, T40, T45, T50		
1147R	T10H, T15H, T20H, T25H, T27H, T30H, T40H		
4023	T30, T40, T45, T50, T55		
4375M	E10, E12, E14, E16, E18		



26 PC.

9-1303MR Tray category #5 (265 x 185mm)

Contents		0.50 kg	1 / 10
1930	10 x 11, 12 x 14, 14 x 17		



3 PC.

9-1905MR Tray category #5 (265 x 185mm)

Contents		0.82 kg	1 / 10
1950	10 x 12, 11 x 13, 14 x 17, 16 x 18, 19 x 22		



5 PC.

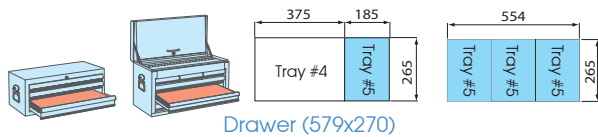

Drawer (579x270)

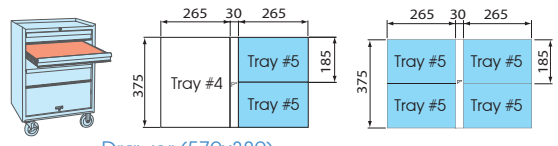

Drawer (579x380)

Tool Set Content

9-10112MR

KT NO.	Contents	kg	1.22	1 / 10
9-10112MR	3731M 10, 11, 12, 13, 14, 15, 16, 17, 19			
9-102A12MR	373AM			

9-102A12MR Tray category #5 (265 x 185mm)



12 PC.

9-40103GP

Tray category #5 (265 x 185mm)

Contents	kg	0.83	1 / 10
6111-07	6211-06		
6311-06			



3 PC.

9-31106MR

Tray category #5 (265 x 185mm)

Contents	kg	0.60	1 / 10
⊕ 1421 PH0 x 60, PH1 x 80, PH2 x 100			
⊖ 1422 3 x 75, 5.5 x 100, 6.5 x 150			



6 PC.

9-4128FR

Tray category #5 (265 x 185mm)

Contents	kg	1.70	1 / 10
⊕ 1836P PH2, PH3			
⊖ 1836S 9, 11			
⊕ 1880P PH2, PH3			
⊖ 1880S 8, 10			
4112 414810S			



10 PC.

9-20110MR

Tray category #5 (265 x 185mm)

Contents	kg	1.10	1 / 10
1120MR H1.5, H2, H2.5, H3, H4, H5, H6, H8, H10			
3204 (Ø 60 ~ 140)			



10 PC.

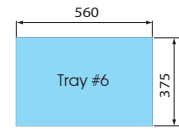

Drawer (579x380)

Tool Set Content

9-7576MR

Tray category #6 (560 x 375mm)

Contents

7.69 1 / 3

	3335M	8, 10, 11, 12, 13, 14, 15, 16, 17, 19, 20, 21, 22, 24
	3235M	8, 10, 11, 12, 13, 14, 15, 16, 17, 19, 21, 22, 24
	4335MR	10, 11, 12, 13, 14, 15, 16, 17, 18, 19, 20, 21, 22, 23, 24, 27, 30, 32
	4235M	10, 12, 13, 14, 17, 19, 21, 22, 24
	9TD403	12, 13, 14, 17, 19
	321510M	366516
	321512M	366521 3792
	3452-08F	3769-08P 4311-16F
	4768-10P	4452-18FR 4573-10



76 PC.

Contents

	4251-03R		3221-03
	4251-05R		3221-06
	4251-10R		3221-10

9-94435MP

Tray category #6 (560 x 375mm)

Contents

6.49 1 / 3

	4435M	10, 11, 12, 13, 14, 15, 16, 17, 18, 19, 21, 24, 26, 29, 32
	4535M	10, 12, 13, 14, 17, 19, 21, 24
	4415M	17, 19, 21, 22
	4797P	68SS-07 68HS-07
	6011-10R	6211-06 6311-08
	6463-08C	74030



35 PC.

9-31919MR

Tray category #6 (560 x 375mm)

Contents

2.67 1 / 5

	1411	PH0 x 75, PH2 x 38
	1412	3 x 75, 6.5 x 38
	1421	PH2 x 300
	1422	6.5 x 300
	1481	PH2 x 100, PH3 x 150
	1482	6.5 x 100, 8 x 150
	1427	T8H x 75, T10H x 75, T15H x 75, T20H x 100, T25H x 100, T27H x 100, T30H x 125
	43280212	2121-18



19 PC.

9-90408TQ

Tray category #6 (560 x 375mm)

Contents

2.06 1 / 5

	75102-08G		75202-08G
	75302-08G		75402-08G
	75502-08G		79063-12
	79093-05C		7911-12



8 PC.



Tool Set Content

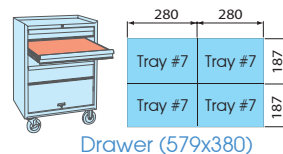

9-4057MR

Tray category #7 (280 x 187mm)

Contents 2.99 1 / 4

- 4330MR 8, 9, 10, 11, 12, 13, 14, 15, 16, 17, 18, 19, 20, 21, 22, 23, 24, 25, 26, 27, 28, 29, 30, 32, 33, 34, 36



27 PC.

9-4557MR

Tray category #7 (280 x 187mm)

Contents 2.99 1 / 4

- 4335MR 8, 9, 10, 11, 12, 13, 14, 15, 16, 17, 18, 19, 20, 21, 22, 23, 24, 25, 26, 27, 28, 29, 30, 32, 33, 34, 36



27 PC.

9-4138PR

Tray category #7 (280 x 187mm)

Contents 1.9 1 / 10

- 4033 T20, T25, T27, T30, T40, T45, T50, T55, T60
- 4035 H4, H5, H6, H7, H8, H10, H12, H14, H17



18 PC.

9-7128PR

Tray category #7 (280 x 187mm)

Contents 1.20 1 / 10

- 3025 H3, H4, H5, H6, H7, H8, H10, H12
- 3023 T15, T20, T25, T27, T30, T40, T45, T50
- 3375M E8, E10, E12, E14, E16, E18
- 4375M E10, E12, E14, E16, E18, E20



28 PC.

9-4427MP

Tray category #7 (280 x 187mm)

Contents 4.09 1 / 4

- 4535M 8, 9, 10, 11, 12, 13, 14, 15, 16, 17, 18, 19, 20, 21, 22, 23, 24, 25, 26, 27, 28, 29, 30, 32, 33, 34, 36



27 PC.

9-4827MP

Tray category #7 (280 x 187mm)

Contents 4.09 1 / 4

- 4530M 8, 9, 10, 11, 12, 13, 14, 15, 16, 17, 18, 19, 20, 21, 22, 23, 24, 25, 26, 27, 28, 29, 30, 32, 33, 34, 36



27 PC.

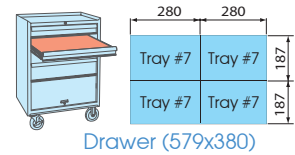

Tool Set Content

9-12C7MR Tray category #7 (280 x 187mm)

Contents		0.78 kg	1 / 10
	1061	8, 10, 11, 13, 14, 17, 19	



7 PC.

9-3612MR Tray category #7 (280 x 187mm)

Contents		1.27 kg	1 / 10
	3351MR	8, 9, 10, 11, 12, 13, 14, 15, 16, 17, 18, 19	



12 PC.

9-30904AY Tray category #7 (280 x 187mm)

- Use for scribing, aligning, installing and removing O rings, seals and washers stainless

Contents		0.43 kg	1 / 10
	43250115Y		43270115Y
	43260115Y		43290115Y



4 PC.

Tool Set Content

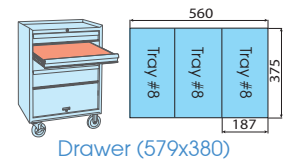

9-30909AY Tray category #8 (375 x 187mm)

Contents		0.69 kg	1 / 12
	43250115Y		43350175Y
	43260115Y		43360175Y
	43270115Y		43370175Y
	43290115Y		43390175Y
	43240115Y		



9 PC.

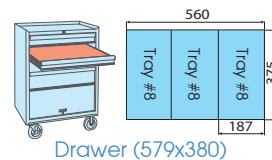

Tool Set Content

9-12110MR Tray category #8 (375 x 187mm)

Contents	1.89	/ 1 / 12
3731M	8, 10, 12, 13, 14, 17, 19, 21, 22, 24	



10
PC.

9-90114MR Tray category #8 (375 x 187mm)

Contents	1.75	/ 1 / 12
1930	8 x 10, 10 x 11, 12 x 14, 14 x 17, 17 x 19	
1060	8, 10, 12, 14, 17, 19, 21, 22, 24	



14
PC.

9-40618GP Tray category #8 (375 x 187mm)

Contents	1.89	/ 1 / 12
1471	PH1 x 100, PH2 x 100	
1472	4 x 100, 5.5 x 125	
6CB02	100~500V	
6318-08A	6116-07A	6216-06A



8
PC.

9-1011GP Tray category #8 (375 x 187mm)

Contents	1.15	/ 1 / 12
761G	ø6x185mm	
763G	ø4x185mm, ø5x185mm ø6x185mm, ø8x185mm	
764G	ø2x140mm, ø3x150mm, ø4x180mm, ø5x200mm, ø6x210mm, ø8x220mm	



11
PC.

9-91016MR Tray category #8 (375 x 187mm)

Contents	1.15	/ 1 / 12
3730M	8, 10, 12, 13, 14, 17, 19	
1123R	T10, T15, T20, T25, T27, T30, T40, T45, T50	



16
PC.

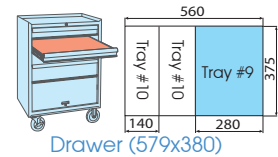

Tool Set Content

9-4335MR

KT NO.	Contents	kg 5.01	1/2
9-4335MR	○ 4235M	8, 9, 10, 11, 12, 13, 14, 15, 16, 17, 18, 19, 20, 21, 22, 23, 24, 25, 26, 27, 28, 29, 30, 32, 36	1/2
9-4235MR	○ 4230M		

9-4235MR Tray category #9 (375 x 280mm)



25 PC.

9-4435MP Tray category #9 (375 x 280mm)

Contents	kg 7.3	1/2
○ 4435M	8, 9, 10, 11, 12, 13, 14, 15, 16, 17, 18, 19, 20, 21, 22, 23, 24, 25, 26, 27, 28, 29, 30, 32, 36	1/2



25 PC.

9-6414MP

9-6414SP Tray category #9 (375 x 280mm)

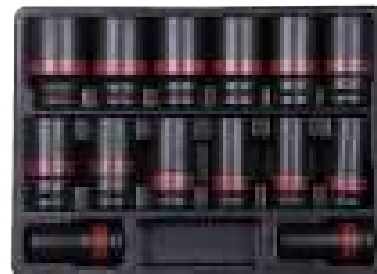

14 PC.

KT NO.	Contents	kg 10.9	1/2
9-6414MP	○ 6435M	19, 21, 22, 24, 26, 27, 29, 30, 32, 33, 35, 36, 38, 41	1/2
9-6414SP	○ 6435S		

9-12A1MR Tray category #9 (375 x 280mm)

Contents	kg 1.91	1/4
○ 1061	8, 10, 12, 13, 14, 16, 17, 18, 19, 22, 24	1/4



11 PC.



Tool Chest Set Content

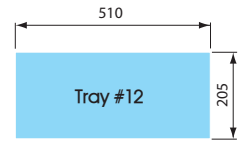
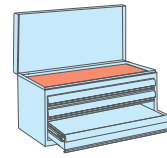

Drawer (504 x 195 mm)

9-4338MR

9-4338MR01

9-4338MR03

Tray category #12 (510 x 205mm)

For Top drawer of 87401-2 / 87401-3 / 87401-3H P.51

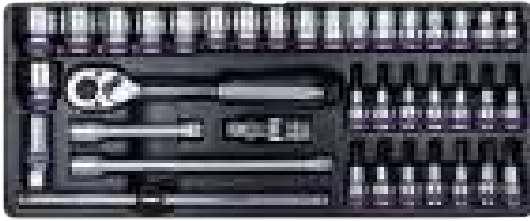

9-4338MR



9-4338MR01 / 9-4338MR03

38
PC.

KT NO.	Contents	Weight	Volume
9-4338MR	10, 11, 12, 13, 14, 15, 16, 17, 18, 19, 20, 21, 22, 23, 24, 27, 30, 32	5.96 kg	1 / 5
9-4338MR01	4335MR		
9-4338MR03	8, 10, 11, 12, 13, 14, 15, 16, 17, 18, 19, 20, 21, 22, 24, 27, 30, 32		

Part No.	Description	Part No.	Description
4768-10F	4021 PH2, PH3	4251-05R	4251-10R
4755-10G	4022 8, 10	4572-12	
4755-10G	4023 T25, T27, T30, T40	4791R	
	4025 H4, H5, H6, H8, H10, H12	463521RC	

for 87401-2 / 87401-3 / 87401-3H P.51

Tool Chest Set Content

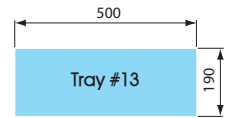
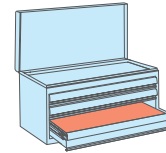

Drawer (504 x 195 mm)

9-90121MR

Tray category #13 (500 x 190mm)

Contents	Weight	Volume
1900 6 x 7, 8 x 10, 11 x 13, 12 x 13, 17 x 19, 22 x 24	2.1 kg	1 / 5
1970 8 x 9, 10 x 11, 12 x 13, 14 x 15, 16 x 17, 18 x 19		
1120MR H1.5, H2, H2.5, H3, H4, H5, H6, H8, H10		



21
PC.

9-90126MR

Tray category #13 (500 x 190mm)

Contents	Weight	Volume
1060 6, 7, 8, 9, 10, 11, 12, 13, 14, 15, 16, 17, 18, 19, 20, 21, 22	2.38 kg	1 / 5
1120MR H1.5, H2, H2.5, H3, H4, H5, H6, H8, H10		



26
PC.

9-90104GP

Tray category #13 (500 x 190mm)

Contents	Weight	Volume
3611-08P 6511-10	1.36 kg	1 / 5
6111-07 6311-06		



4
PC.

▪ for 87401-2 / 87401-3 / 87401-3H P.51

Tool Chest Set Content

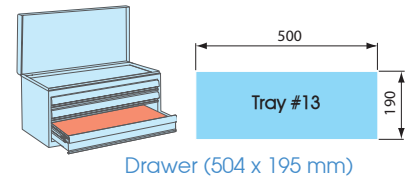

9-31006MR

Tray category #13 (500 x 190mm)

Contents

0.74 kg 1 / 5

⊕ 1421 PH1 x 80, PH2 x 38, PH3 x 150

⊖ 1422 6.5 x 38, 5.5 x 100, 8 x 175

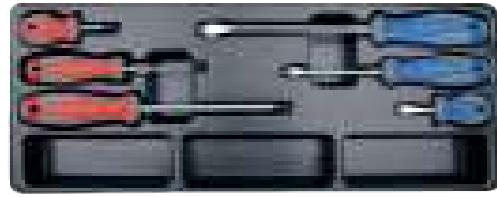

6 PC.

9-90113MA

Tray category #13 (500 x 190mm)

Contents

2.98 kg 1 / 5

4023 T45

4025 H8, H12

402B M16

3204 401408M 9AE42

112005MR 9AE2-6606 9AE2-7614
112006MR 9AE2-7608 9AE2-9315



13 PC.

▪ For 87402 / 87A05 P.52

Tool Box Set Content

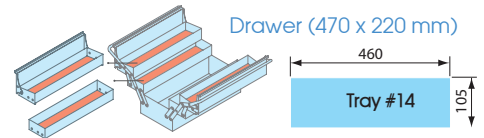

9-4219MR

9-4219MR07

9-4219SR08

9-4319MR

9-4319MR01

9-4319MR02

9-4319MR05

Tray category #14 (460 x 105mm)



9-4219MR



9-4219MR07



9-4219SR08



9-4319MR/9-4319MR05



9-4319MR02



9-4319MR01

20 PC.

KT NO.

Contents

2.5 kg 1 / 8

KT NO.	Contents	
9-4219MR	4768-10F 4330MR	10, 11, 12, 13, 14, 15, 16, 17, 18, 19, 20, 21, 22, 23, 24, 27, 30, 32
9-4219MR07	4762-10F 4330MR	10, 11, 12, 13, 14, 15, 16, 17, 18, 19, 20, 21, 22, 23, 24, 25, 26, 27
9-4219SR08	4762-10F 4330SR	5/16, 3/8, 7/16, 15/32, 1/2, 9/16, 19/32, 5/8, 11/16, 3/4, 25/32, 13/16, 7/8, 15/16, 1, 1-1/16, 1-3/16, 1-1/4
9-4319MR	4768-10F	4791R
9-4319MR01	4755-10G 4335MR	
9-4319MR02	4779-10FR	
9-4319MR05	4768-10F	



▪ For 87402 / 87A05 P.52

Tool Box Set Content

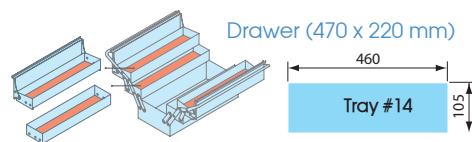

9-4116FR

9-4116FR03 Tray category #14 (460 x 105mm)



6 PC.

KT NO.	Contents			kg	1/8
9-4116FR	463521RC	4251-05R 4251-10R	4572-12	2.2	1 / 8
9-4116FR03	463021RC	4452-18FR	4223-02R		

9-1217MR



7 PC.

Contents	kg	1/8
1060 17, 18, 19, 20, 21, 22, 24	1.5	1 / 8

9-90115MR



15 PC.

Contents	kg	1/8
1900 6 x 7, 8 x 10, 11 x 13, 12 x 13, 17 x 19, 22 x 24	1.2	1 / 8
1120MR H1.5, H2, H2.5, H3, H4, H5, H6, H8, H10		

9-90120MR



20 PC.

Contents	kg	1/8
1060 6, 7, 8, 9, 10, 11, 12, 13, 14, 15, 16	1.5	1 / 8
1120MR H1.5, H2, H2.5, H3, H4, H5, H6, H8, H10		

9-90125MR



15 PC.

Contents	kg	1/8
1900 8 x 10, 10 x 12, 12 x 14, 14 x 17, 17 x 19, 22 x 24	1.2	1 / 8
1120MR H1.5, H2, H2.5, H3, H4, H5, H6, H8, H10		

9-1606MR

9-1606MR01 Tray category #14 (460 x 105mm)



6 PC.

KT NO.	Contents		kg	1/8
9-1606MR	1960		1.1	1 / 8
9-1606MR01	10 x 12, 12 x 14, 14 x 17, 17 x 19, 19 x 21, 23 x 26			
	8 x 10, 10 x 12, 12 x 14, 14 x 17, 17 x 19, 22 x 24			

9-1716MR



6 PC.

Contents	kg	1/8
1970 8 x 9, 10 x 11, 12 x 13, 14 x 15, 16 x 17, 18 x 19	1.1	1 / 8

9-40203GP



3 PC.

Contents	kg	1/8
6111-07 6211-06	0.8	1 / 8
6311-06		

9-30106MR



6 PC.

Contents	kg	1/8
1421 PH1 x 80, PH2 x 100, PH3 x 150	0.8	1 / 8
1422 5.5 x 100, 6.5 x 150, 8 x 175		

9-30206MR



6 PC.

Contents	kg	1/8
1461 PH1 x 75, PH2 x 100, PH3 x 150	1.18	1 / 8
1462 5.5 x 100, 6.5 x 150, 8 x 175		

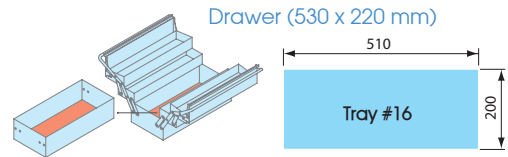
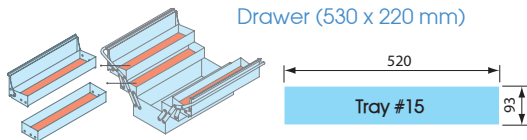

▪ For 87408 only P.52

Tool Box Set Content

9-4029CR Tray category #15 (520 x 93mm)

29 PC.



Contents		kg 2.67	1 / 5
● 4025	H5, H6, H8, H10, H12, H14		
○ 4330MR	8, 10, 11, 12, 13, 14, 15, 16, 17, 19, 21, 22, 23, 24, 26, 27, 28, 30, 32		
○ 4330SR	7/16, 9/16, 7/8		
○ 463521RC			

9-6010MR Tray category #16 (510 x 200mm)

9-6010MR01

10 PC.

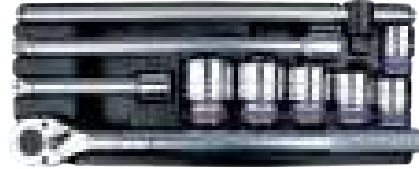

KT NO.	Contents		kg	1 / 2
9-6010MR	○ 6330M	33, 36, 38, 41, 46, 50	9.70	1 / 2
9-6010MR01		30, 32, 36, 41, 46, 50	9.50	
		6779-20F		
		6251-08 6251-16		
		6572-20		

9-4156PR Tray category #15 (520 x 93mm)

6 PC.



Contents		kg 1.99	1 / 5
● 4779-10GR	4572-12		
○ 4251-03R	4791R		
○ 4251-05R			
○ 4251-10R			

9-1215MR03 Tray category #16 (510 x 200mm)

15 PC.



Contents		kg 3.12	1 / 2
○ 1060	8, 10, 11, 12, 13, 14, 17, 18, 19, 21, 22, 24, 27, 30, 32		

9-90111MR Tray category #15 (520 x 93mm)

11 PC.



Contents		kg 1.25	1 / 5
● 1145MR	H1.5, H2, H2.5, H3, H4, H5, H6, H8, H10		
○ 3611-10P	6511-10C		



HAND SOCKETS & ACCESSORIES



KINGTOM
38993EW

Socket Made



Precision forging Technology



Other brand (not good) King Tony brand (good)

In forging process, metal moved while it is still in the solid state. King Tony specialized in forging technology to create better metal configuration. Non-straight grain flow and non-sharp corners can extend lifetime and durability of socket. Torque is transmitted for powerful tightening under safety.

Conventional heat treatment and microstructural

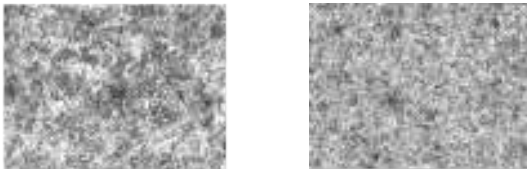

Other brand: Over of Troostite (Zn,Mn) element will bring weak point. (not good) King Tony brand: Well spread (Fe) element will bring better strength. (good)

Heat treatment involves the use of heating or chilling experience and time control. King Tony controls heat treatment system to ensure the right hardness without the brittleness. From microstructural picture you can see elements are well-distributed.

Professional production & quality control



KING TONY hand socket reach 30% higher than DIN international standard.

Quality control also ensure that a sufficient level of production output. King Tony uses advance technology to inspect tiny difference on each step. Our hand socket, ratchet, extension bar, and power handle is 30% higher than international DIN standards. Impact socket reach 50% higher torque than DIN standards.

Finest material for tools

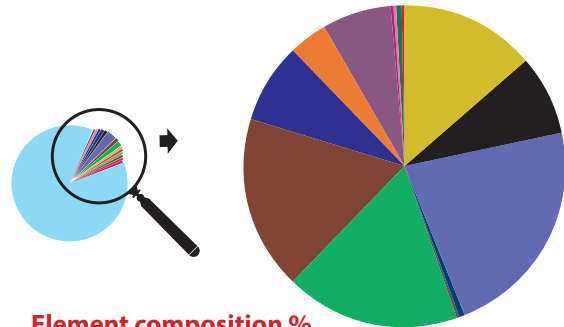

Element composition %

• Fe	97.1025%	• Mo	0.2325%	• P	0.0125%
• Mn	0.6485%	• Si	0.2301%	• S	0.0104%
• Ni	0.5089%	• Cu	0.1970%	• Co	0.0092%
• Cr	0.5058%	• V	0.1130%	• W	0.0088%
• C	0.4000%	• Al	0.0196%	• B	0.0012%

Tools are made to extend hand work. King Tony selects different material depends on its difference of nature for tightening, power impacting, cutting, rotating, and locking. Choose qualified material to meet required lifetime for professional use and consumption.

Extremely hard-wearing performance

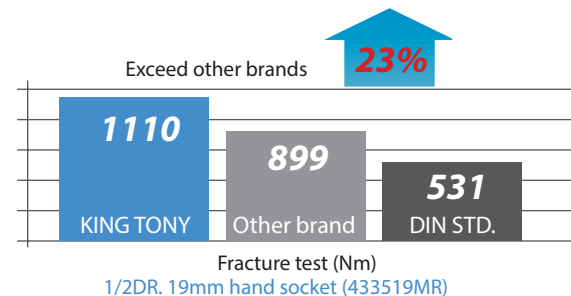
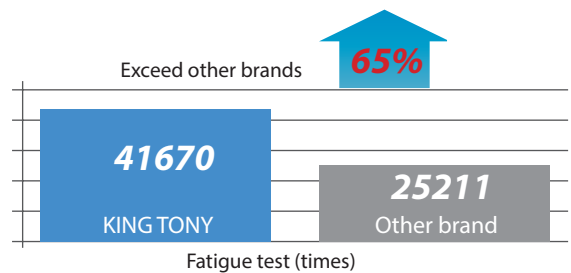

King Tony offers reliable tools for professional users, strictly controls its quality to ensure achievement of required performance. From "fracture & fatigue test", you will know the difference we have when compare to others.

Standard Socket

KT No. & D1



2330M

- Metric-DIN 3124, ISO 2725-1
- Inch-ANSI/ASME B107.1

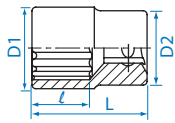

2330S 1/4"



KT NO.	mm	D1 mm	D2 mm	l mm	L mm	Weight	Box
233004M	4	6.8	11.8	4	24	9	20 / 600
233045M	4.5	7.4	11.8	5	24	9	20 / 600
233005M	5	8.0	11.8	6	24	9	20 / 600
233055M	5.5	8.7	11.8	6	24	11	20 / 600
233006M	6	9.2	11.8	7	24	11	20 / 600
233007M	7	10.3	11.8	7	24	10	20 / 600
233008M	8	11.4	11.8	8	24	12	20 / 600
233009M	9	12.8	12.0	8	24	12	20 / 600
233010M	10	14.3	13.0	9	24	13	12 / 360
233011M	11	15.8	14.2	9	24	18	12 / 360
233012M	12	16.8	15.5	9	24	21	12 / 360
233013M	13	17.8	16.5	9	24	23	12 / 360
233014M	14	19.6	18.5	9	24	31	10 / 360

KT NO.	inch	D1 mm	D2 mm	l mm	L mm	Weight	Box
233005S	5/32	6.8	11.8	4	24	9	20 / 600
233006S	3/16	7.9	11.8	6	24	9	20 / 600
233007S	7/32	8.7	11.8	6	24	10	20 / 600
233008S	1/4	9.5	11.8	7	24	10	20 / 600
233009S	9/32	10.3	11.8	7	24	10	20 / 600
233010S	5/16	11.4	11.8	8	24	10	20 / 600
233011S	11/32	13.7	12.2	8	24	12	20 / 600
233012S	3/8	14.2	13.0	8	24	14	12 / 360
233014S	7/16	15.8	14.2	9	24	18	12 / 360
233015S	15/32	16.8	15.5	9	24	21	12 / 360
233016S	1/2	17.6	16.5	9	24	24	12 / 360

2335M

- Metric-DIN 3124, ISO 2725-1
- Inch-ANSI/ASME B107.1

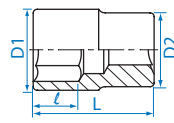

2335S 1/4"



KT NO.	mm	D1 mm	D2 mm	l mm	L mm	Weight	Box
233532M	3.2	5.7	11.8	3.5	24	9	20 / 600
233504M	4	6.8	11.8	4	24	9	20 / 600
233545M	4.5	7.4	11.8	5	24	10	20 / 600
233505M	5	8.0	11.8	6	24	10	20 / 600
233555M	5.5	8.7	11.8	6	24	10	20 / 600
233506M	6	9.2	11.8	7	24	10	20 / 600
233507M	7	10.3	11.8	7	24	11	20 / 600
233508M	8	11.4	11.8	8	24	11	20 / 600
233509M	9	12.8	12.0	8	24	13	20 / 600
233510M	10	14.3	13.0	9	24	14	12 / 360
233511M	11	15.8	14.2	9	24	19	12 / 360
233512M	12	16.8	15.5	9	24	22	12 / 360
233513M	13	17.8	16.5	9	24	25	12 / 360
233514M	14	19.6	18.5	9	24	32	10 / 300
233515M	15	20.9	19.3	12	24	39	10 / 300

KT NO.	inch	D1 mm	D2 mm	l mm	L mm	Weight	Box
233505S	5/32	6.8	11.8	4	24	9	20 / 600
233506S	3/16	7.9	11.8	6	24	11	20 / 600
233507S	7/32	8.7	11.8	6	24	11	20 / 600
233508S	1/4	9.5	11.8	7	24	11	20 / 600
233509S	9/32	10.3	11.8	7	24	11	20 / 600
233510S	5/16	11.4	11.8	8	24	11	20 / 600
233511S	11/32	13.7	12.2	8	24	12	20 / 600
233512S	3/8	14.2	13.0	8	24	14	12 / 360
233514S	7/16	15.8	14.2	9	24	19	12 / 360
233515S	15/32	16.8	15.5	9	24	22	12 / 360
233516S	1/2	17.6	16.5	9	24	24	12 / 360
233518S	9/16	19.6	18.5	9	24	31	10 / 300

Deep Socket

2235M

- DIN 3124, ISO 2725-1

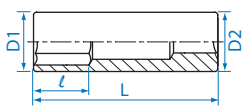

1/4"



KT NO.	mm	D1 mm	D2 mm	l mm	L mm	Weight	Box
223504M	4	6.9	11.6	6	49.5	18	20 / 320
223545M	4.5	7.5	11.6	6	49.5	20	20 / 320
223505M	5	8.0	11.6	7	49.5	21	20 / 320
223555M	5.5	8.8	11.6	7	49.5	21	20 / 320
223506M	6	9.5	11.6	8	49.5	22	20 / 320
223507M	7	10.5	11.6	12	49.5	23	20 / 320
223508M	8	11.8	11.8	15	50	24	20 / 320
223509M	9	13.0	13.0	15	50	30	15 / 240
223510M	10	14.5	14.5	15	50	38	15 / 240
223511M	11	15.8	15.8	21	50	43	15 / 240
223512M	12	16.8	16.8	21	50	48	15 / 240
223513M	13	17.8	17.8	21	50	52	15 / 240
223514M	14	19.8	19.8	21	50	69	15 / 240
223515M	15	20.9	20.9	25	50	71	12 / 240

2235S

- Inch-ANSI/ASME B107.1

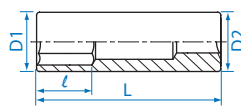

1/4"

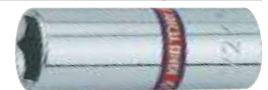

KT NO.	inch	D1 mm	D2 mm	l mm	L mm	Weight	Box
223505S	5/32	6.8	11.8	6	50	19	20 / 320
223506S	3/16	7.9	11.8	7	50	20	20 / 320
223507S	7/32	8.7	11.8	9	50	21	20 / 320
223508S	1/4	9.5	11.8	9	50	23	20 / 320
223509S	9/32	10.3	11.8	15	50	24	20 / 320
223510S	5/16	11.8	11.8	15	50	25	20 / 320
223511S	11/32	13.0	13.0	15	50	32	15 / 240
223512S	3/8	14.5	14.5	15	50	41	15 / 240
223514S	7/16	15.8	15.8	21	50	47	15 / 240
223516S	1/2	17.6	17.6	21	50	54	15 / 300
223518S	9/16	19.6	19.6	21	50	71	15 / 270

Deep Socket

2230M

1/4"

- DIN 3124, ISO 2725-1

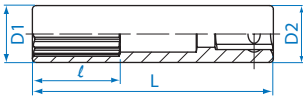

KT NO.	mm	D1 mm	D2 mm	l mm	L mm	⚖️	📦
223004M	4	6.8	11.8	6	50	20	20 / 320
223045M	4.5	7.4	11.8	7	50	20	20 / 320
223005M	5	8.0	11.8	7	50	20	20 / 320
223055M	5.5	8.7	11.8	9	50	20	20 / 320
223006M	6	9.2	11.8	9	50	21	20 / 320
223007M	7	10.3	11.8	15	50	22	20 / 320
223008M	8	11.8	11.8	15	50	25	20 / 320
223009M	9	13.0	13.0	15	50	28	15 / 240
223010M	10	14.5	14.5	15	50	36	15 / 240
223011M	11	15.8	15.8	21	50	41	15 / 240
223012M	12	16.8	16.8	21	50	47	15 / 240
223013M	13	17.8	17.8	21	50	49	15 / 240
223014M	14	19.8	19.8	21	50	66	15 / 240

Double Square Socket

2310M

2310S

1/4"

- Metric-DIN 3120
- Inch-ANSI / ASME B107.1

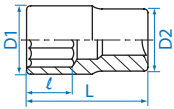

KT NO.	mm	D1 mm	D2 mm	l mm	L mm	⚖️	📦
231008M	8	13.8	13.0	9	24	16	12 / 360
231010M	10	16.8	15.4	9	24	22	12 / 360

KT NO.	inch	D1 mm	D2 mm	l mm	L mm	⚖️	📦
231010S	5/16	13.8	13.0	9	24	15	12 / 360
231012S	3/8	16.8	15.4	9	24	24	12 / 360

Star Socket

2375M

1/4"

- DIN 3120

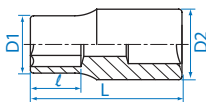

KT NO.	Size	D1 mm	D2 mm	l mm	L mm	⚖️	📦
237504M	E4	6.0	11.8	3.6	24	9	20 / 600
237505M	E5	7.0	11.8	4.0	24	10	20 / 600
237506M	E6	8.0	11.8	6.0	24	10	20 / 600
237507M	E7	8.5	11.8	7.0	24	11	20 / 600
237508M	E8	9.8	11.8	8.0	24	11	20 / 600
237510M	E10	11.8	11.8	9.0	24	13	20 / 600

Star Socket

2275M

1/4"

- DIN 3120

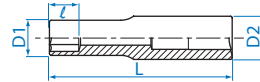

KT NO.	Size	D1 mm	D2 mm	l mm	L mm	⚖️	📦
227504M	E4	6.0	11.8	3.6	50	21	20 / 320
227505M	E5	7.0	11.8	4.0	50	22	20 / 320
227506M	E6	8.0	11.8	6.0	50	24	20 / 320
227507M	E7	8.5	11.8	7.0	50	24	20 / 320
227508M	E8	9.8	11.8	8.0	50	26	20 / 320

Bit Socket



In order to get normal life of bit socket, always use within limited torque to bit.

2011X

1/4"

- Phillips head
- DIN ISO 8764-1

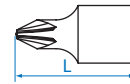

KT NO.	No.	L mm	⚖️	📦
201101X	PH1	25	9	20 / 600
201102X	PH2	25	9	20 / 600
201103X	PH3	25	10	20 / 600
201104X	PH4	25	12	20 / 600

2012X

1/4"

- Slotted head
- DIN ISO 2380-1

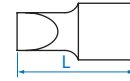

KT NO.	Tip width mm	Tip thickness mm	L mm	⚖️	📦
201235X	3.5	0.6	25	8	20 / 600
201255X	5.5	1.0	25	9	20 / 600
201208X	8	1.2	25	10	20 / 600

2015X

1/4"

- Hexagon head
- DIN ISO 2380-1

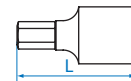

KT NO.	mm	L mm	⚖️	📦
201503MX	H3	25	8	20 / 600
201504MX	H4	25	9	20 / 600
201505MX	H5	25	10	20 / 600
201506MX	H6	25	10	20 / 600
201508MX	H8	25	13	20 / 600
201510MX	H10	25	15	20 / 600
201506SX	3/16	25	9	20 / 600
201508SX	1/4	25	10	20 / 600

Bit Socket

KT No. & D1



2013X



- For torx internal screw

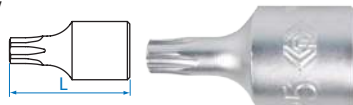

KT NO.	Size	L mm	Weight	Packaging
201308X	T8	25	8	20 / 600
201309X	T9	25	8	20 / 600
201310X	T10	25	8	20 / 600
201315X	T15	25	8	20 / 600
201320X	T20	25	9	20 / 600
201325X	T25	25	9	20 / 600
201327X	T27	25	9	20 / 600
201330X	T30	25	10	20 / 600
201340X	T40	25	11	20 / 600

2018X



- Pozidriv head
- DIN ISO 8764-1



KT NO.	No.	L mm	Weight	Packaging
201801X	PZ1	25	9	20 / 600
201802X	PZ2	25	9	20 / 600
201803X	PZ3	25	10	20 / 600
201804X	PZ4	25	11	20 / 600

2031



- Phillips head
- DIN ISO 8764-1



KT NO.	No.	L mm	Weight	Packaging
203101	PH1	37	15	20 / 600
203102	PH2	37	15	20 / 600
203103	PH3	37	15	20 / 600
203104	PH4	37	16	20 / 600

2032



- Slotted head
- DIN ISO 8764-1



KT NO.	Tip width mm	Tip thickness mm	L mm	Weight	Packaging
203235	3.5	0.5	37	15	20 / 600
203204	4	0.8	37	14	20 / 600
203255	5.5	1.0	37	15	20 / 600
203265	6.5	1.2	37	15	20 / 600
203207	7	1.2	37	15	20 / 600
203208	8	1.2	37	16	20 / 600
203210	10	1.6	37	20	20 / 600

2035

2035S



- Hexagon head
- DIN 7422 / 3120

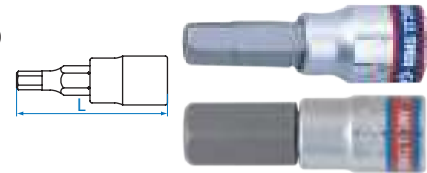

KT NO.	mm	L mm	Weight	Packaging
203503	H3	37	15	20 / 600
203504	H4	37	15	20 / 600
203505	H5	37	15	20 / 600
203506	H6	37	16	20 / 600
203507	H7	37	18	20 / 600
203508	H8	37	19	20 / 600
203510	H10	37	23	20 / 600

KT NO.	inch	L mm	Weight	Packaging
203504S	H1/8	37	15	20 / 600
203505S	H5/32	37	15	20 / 600
203506S	H3/16	37	16	20 / 600
203507S	H7/32	37	17	20 / 600
203508S	H1/4	37	18	20 / 600
203510S	H5/16	37	19	20 / 600
203512S	H3/8	37	22	20 / 600



Bit Socket

KT No. & D1



2033



- For torx internal screw
- DIN 3120



KT NO.	Size	L mm		
203308	T8	37	14	20 / 600
203309	T9	37	14	20 / 600
203310	T10	37	14	20 / 600
203315	T15	37	14	20 / 600
203320	T20	37	15	20 / 600
203325	T25	37	15	20 / 600
203327	T27	37	15	20 / 600
203330	T30	37	16	20 / 600
203340	T40	37	16	20 / 600

2037



- For tamper resistant torx screw
- DIN 3120



KT NO.	Size	L mm		
203708	T8H	37	14	20 / 600
203709	T9H	37	14	20 / 600
203710	T10H	37	14	20 / 600
203715	T15H	37	14	20 / 600
203720	T20H	37	15	20 / 600
203725	T25H	37	15	20 / 600
203727	T27H	37	15	20 / 600
203730	T30H	37	15	20 / 600
203740	T40H	37	16	20 / 600

2038



- Pozidriv head
- DIN 3120



KT NO.	No.	L mm		
203801	PZ1	37	15	20 / 600
203802	PZ2	37	15	20 / 600
203803	PZ3	37	15	20 / 600



90 Teeth Dustproof Ratchet **PAT.**



HAND SOCKET & ACCESSORIES



- Material
 - chrome vanadium alloy steel handle
 - chrome molybdenum steel (gear) driver
- Finishing
 - polished, chrome plated
 - black driver by phosphate sunk

2773-55GS

1/4"
IP 51
2 PC.
PAT.

- 1/4" DR. & 1/2" DR. 90 teeth reversible ratchet
- 90 teeth ratchet mechanism, allowing ratchet action in very tight spaces
- IP51, dustproof design

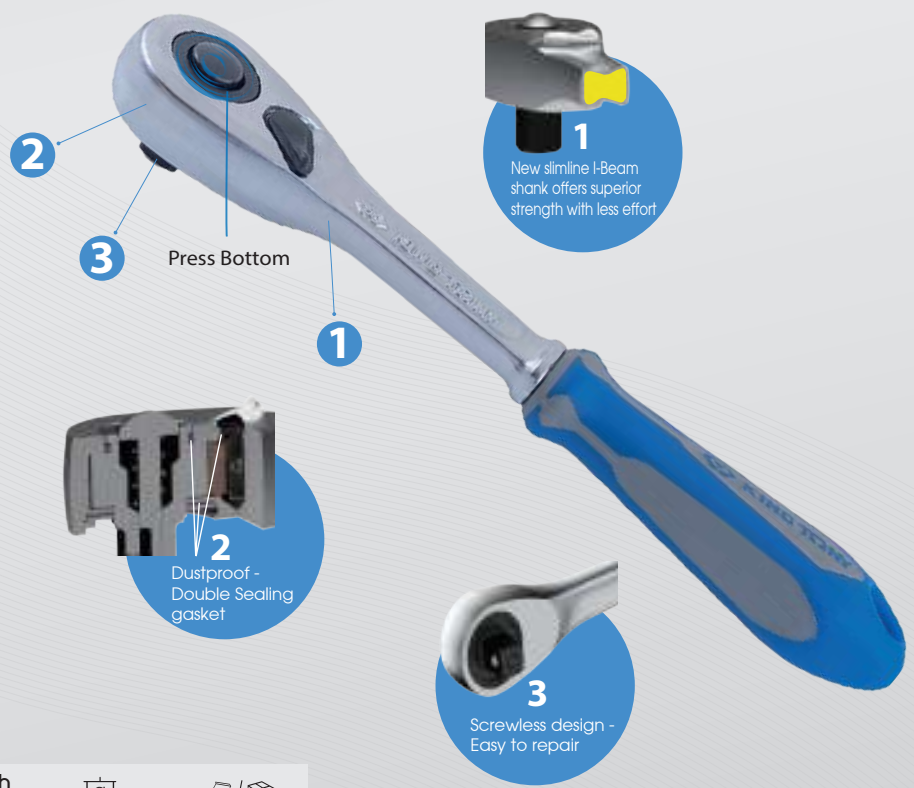

KT NO.	Square DR.	Overall length		Scales	Box / Carton
		inch	mm		
2773-55GS	1/4"	5-1/2"	140	110	1 / 100
2773DK				renewal kits	

Mini Bit Ratchet **PAT.**



HAND SOCKET & ACCESSORIES

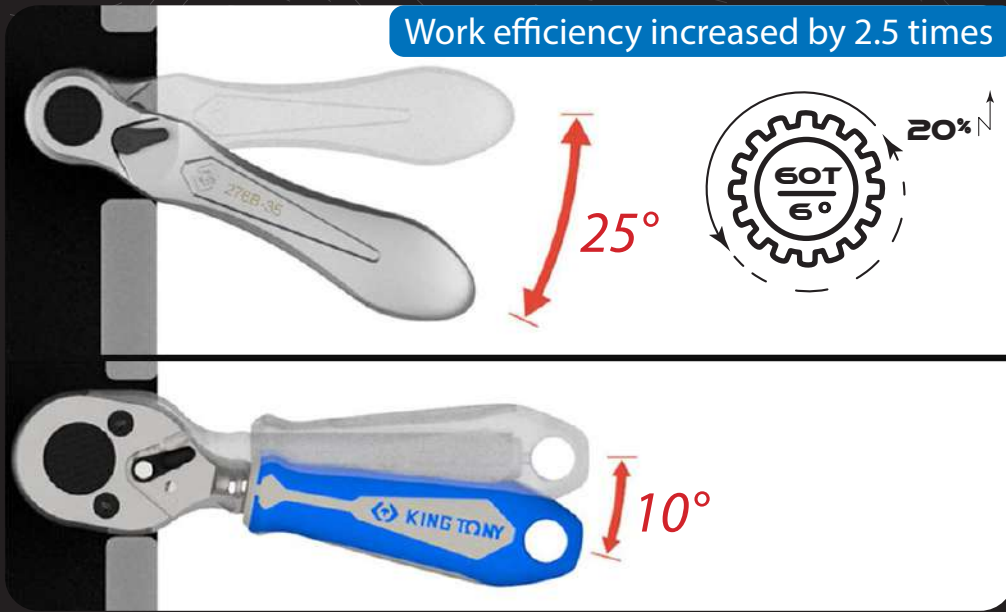

276B-0225

- Reversible ratchet
- 6° gear action degree (60 teeth)
- Quick release design, convenient for users to quickly replace bit
- BIT-holder 12-PT design for quick bit replacement
- Reduced head size and shape of waist can be used quickly and conveniently in narrow spaces

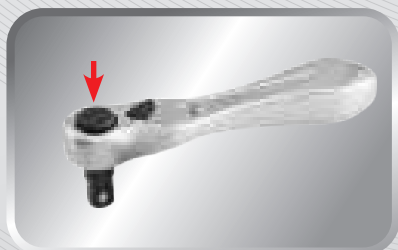

▪ Quick release Design

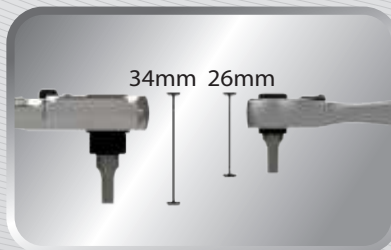

▪ Operating space 30% thinner

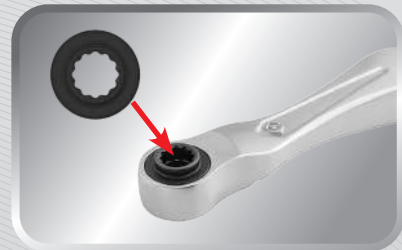

▪ D-head 12 PT design for quick bit replacement

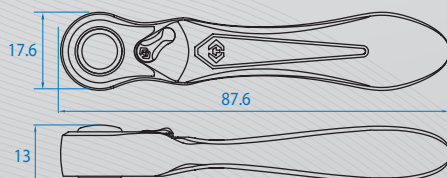

Contents

80 1 / 36

7702-25

276B-35

Ratchet

2725

FINE GEAR 1/4"

- Reversible ratchet
- 8° gear action degree (45 teeth)

KT NO.	Overall length		Scales	Boxes
	inch	mm		
2725-55F	5-1/2	140	156	5 / 90
2725-55G	5-1/2	140	168	5 / 90
2725DK	renewal kits		-	-



2755

FINE GEAR 1/4"

- Reversible ratchet
- 5° gear action degree (72 teeth)
- DIN 3122

KT NO.	Overall length		Scales	Boxes
	inch	mm		
2755-55G	5-1/2	144	113	5 / 90
2755DK	renewal kits		-	-

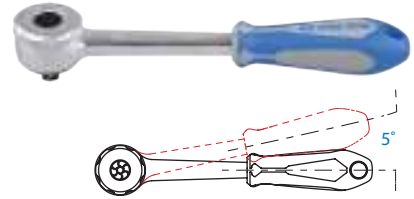

2752

QUICK RELEASE FINE GEAR 1/4"

- Quick release flexible and reversible ratchet
- 5° gear action degree (72 teeth)
- Multi-angle design for difficult-to-reach fasteners

KT NO.	Overall length		Scales	Boxes
	inch	mm		
2752-06G	6	150	128	6 / 108
2752DK	renewal kits		-	-

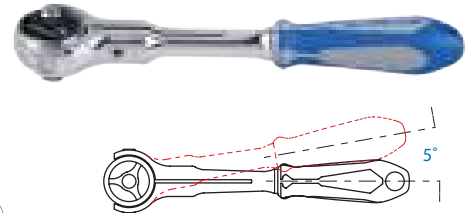

2752-45G

QUICK RELEASE FINE GEAR 1/4"

- Swivel head ratchet
- Quick release flexible and reversible ratchet
- 5° gear action degree (72 teeth)
- Application: T-handle ratchet / screwdriver ratchet

KT NO.	Overall length		Scales	Boxes
	inch	mm		
2752-45G	4-1/2	114	128	6 / 108
2752DK	renewal kits		-	-

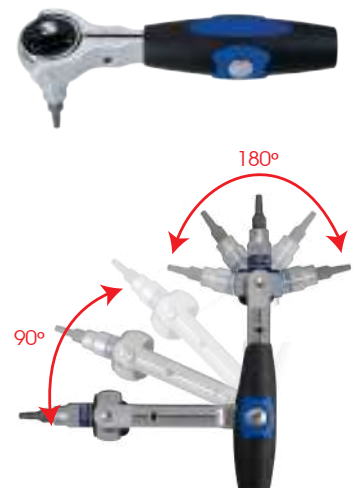

2761

QUICK RELEASE 1/4"

- Quick release reversible ratchet
- 15° gear action degree (24 teeth)
- Two teeth pawl action
- DIN 3122

KT NO.	Overall length		Scales	Boxes
	inch	mm		
2761-55F	5-1/2	140	164	6 / 108
2761-55P	5-1/2	140	156	6 / 108
2761DK	renewal kits		-	-



Ratchet

KT No. & D1

2769

1/4"

- Reversible ratchet
- 15° gear action degree (24 teeth)
- Two teeth pawl action
- DIN 3122

KT NO.	Overall length			
	inch	mm		
2769-55F	5-1/2	140	167	6 / 108
2769-55P	5-1/2	140	159	6 / 108
2769DK	renewal kits		-	-



2769DK



2769-55F



2769-55P

2771

QUICK RELEASE

1/4"

- Quick release reversible ratchet
- 15° gear action degree (24 teeth)
- Two teeth pawl action
- DIN 3122

KT NO.	Overall length			
	inch	mm		
2771-55F	5-1/8	130	142	6 / 108
2771-55G	5-1/8	134	110	6 / 108
2771DK	renewal kits		-	-



2771DK



2771-55F



2771-55G

2773

1/4"

- Quick release reversible ratchet
- 4° gear action degree (90 teeth)
- DIN 3122

KT NO.	Overall length			
	inch	mm		
2773-55GS	5-1/2	140	110	1 / 100
2773DK	renewal kits		-	-



2773DK



2774

1/4"

- Universal joint reversible ratchet
- 15° gear action degree (24 teeth)
- Two teeth pawl action
- DIN 3122



KT NO.	Overall length			
	inch	mm		
2774-55F	5-1/8	130	146	6 / 108
2774-55G	5-1/8	134	114	6 / 108
2774DK	renewal kits		-	-



2774DK



2774-55F



2774-55G

2779

1/4"

- Reversible ratchet
- 15° gear action degree (24 teeth)
- Two teeth pawl action
- DIN 3122

KT NO.	Overall length			
	inch	mm		
2779-55F	5-1/8	130	145	6 / 108
2779-55G	5-1/8	134	113	6 / 108
2779DK	renewal kits		-	-



2779DK



2779-55F



2779-55G

Ratchet

KT No. & D1

2781

QUICK RELEASE

1/4"

- Quick release flexible and reversible ratchet
- 15° gear action degree (24 teeth)
- Two teeth pawl action
- DIN 3122

KT NO.	Overall length			
	inch	mm		
2781-06P	6	150	156	6 / 108
2781DK	renewal kits		-	-



2781DK



2760

MINI RATCHET

1/4"

- Mini reversible ratchet
- 5° gear action degree (72 teeth)
- Two teeth pawl action
- DIN 3122

KT NO.	Overall length			
	inch	mm		
2760-04	4	100	95	8 / 128
2760DK01	renewal kits		-	-



2760DK01



276A

FINE GEAR

MINI RATCHET

1/4"

- Mini bit holder ratchet
- 5° gear action degree (72 teeth)
- Two teeth pawl action

KT NO.	A mm	D mm	L mm	H mm		
276ADK	renewal kits					



276ADK

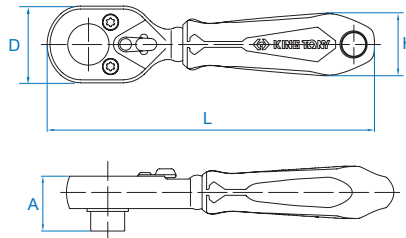

276A-04G (top, side, back)



Mini Ratchet Set

2515MR

1/4"

- Mini ratchet set
- 5° gear action degree (72 teeth)
- Two teeth pawl action

15 PC.



Contents 0.26 6 / 36

		2335M	5, 5.5, 6, 7, 8
		1025P	PH1, PH2
		1025T	T10, T15, T20
		1025H	H3, H4, H5, H6
		276A-04G	

2501MR

1/4"

- 5° gear action degree (72 teeth)
- Two teeth pawl action

21 PC.



Contents 0.36 4 / 48

		2335M	4, 5, 6, 7, 8, 9, 10, 11, 12, 13
		1025P	PH1, PH2, PH3
		1025T	T10, T20, T30
		1025H	H4, H6
		1025S	5.5x1.0, 6.5x1.2
		276A-04G	



Accessory

2745

1/4"

- Palm ratchet bit holder
- Non-toothed palm ratchet is designed for any angle of degree
- 3 position of forward / lock / reverse
- Suitable for narrow space where a standard wrench cannot attain
- Anodized aluminum alloy body & chrome vanadium alloy steel bit holder



KT NO.	Ø1 mm	H		
2745	46	26.5	103	12 / 144

2747

1/4"

- 72-teeth ratcheting mechanism gives a 5° ratcheting arc allowing you to quickly tighten or loosen fasteners.
- Anodized aluminum finish for protection and easy wipe down



2747DR

2747

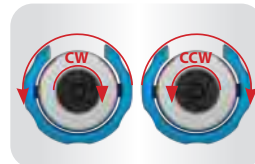

- The special gyroscope-like structure allows you to loosen or lock objects with various angles

KT NO.	Ø (mm)	H (mm)	Teeth		
○ 2747	50	25	72	88	12 / 72
■ 2747DR	50	25	72	90	12 / 72

Accessory

- Material - chrome vanadium alloy steel
- Finishing - polished, chrome plated

KT No. & D1



2221

1/4"

- Extension bar
- DIN 3122



KT NO.	Overall length		⚖️	📦/📦
	inch	mm		
2221-02	2	55	27	30 / 480
2221-03	3	75	36	20 / 400
2221-04	4	100	44	15 / 240
2221-06	6	150	67	15 / 240
2221-10	10	254	107	15 / 240
2221-12	12	305	130	15 / 240

2293

1/4"

- Multi-function extension bar and offset extension bar
- Hex key is applicable to the hex shank
- Max. torque : 35 N·m
- DIN 3123

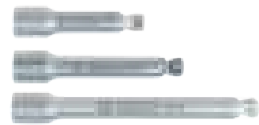

KT NO.	Overall length		⚖️	📦/📦
	inch	mm		
2293-02	2	55	24	30 / 480
2293-03	3	75	34	20 / 400
2293-04	4	100	44	15 / 240
2293-06	6	150	65	15 / 300

2311

1/4"

- Flexible extension bar



KT NO.	Overall length		⚖️	📦/📦
	inch	mm		
2311-06	6	150	65	12 / 240
2311-12	12	300	89	12 / 120
2311-18	18	450	112	20 / 200

2312

1/4"

- Flexible extension bar



KT NO.	Overall length		⚖️	📦/📦
	inch	mm		
2312-06	6	150	59	12 / 240



In order to get normal life of bit socket, Always use within limited torque to bit.

3893EW

1/4" & 3/8"

- Extension wrench
- Length extension drive bar enables easier works in confined spaces
- Provided with two square drive adapters in 1/4" and 3/8"
- Chain-driven mechanism enhances working durability and smoothness
- Max torque allowed: 130 N m / 96 ft lb



3/8"
3893EW-01



1/4"
3893EW-02



KT NO.	Drive	Overall length inch	Overall length mm	Capacity	⚖️	📦/📦
3893EW		13.4	340	300	410	20 / 40
3893EW-01	3/8"	-	-		20	10 / 160
3893EW-02	1/4"	-	-		20	10 / 160

2223

1/4"

- Offset extension bar
- Max. torque: 35 Nm
- DIN 3123



KT NO.	Overall length		⚖️	📦/📦
	inch	mm		
2223-02	2	55	24	30 / 480
2223-04	4	100	44	15 / 240

2792

1/4"

- Universal joint
- DIN 3123



KT NO.	Overall length		⚖️	📦/📦
	inch	mm		
2792	1 - 1/2	36	22	24 / 384

Accessory



2793 1/4"

- Universal joint
- Ball point type universal joint & with hex locking design
- **Short pattern design enables greater access in confined spaces**

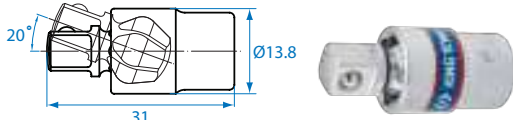

KT NO.	Overall length		g	Box / Kit
	inch	mm		
2793	1-1/4	31	18	20 / 600

9113PR 1/4" 3/8" 1/2"

- Universal joint
- Ball point type universal joint & with hex locking design
- **Short pattern design enables greater access in confined spaces**



3 PC.

Contents	g	Box / Kit
2793 31mm	0.20	6 / 108
3793 43mm		
4793 59mm		

2813 1/4"

- Adapter
- Convert to 3/8" drive
- DIN 3123



3/8" drive (M) ← 1/4" drive (F)

KT NO.	Spec.	g	Box / Kit
2813	1/4" F x 3/8" M	20	12 / 360

213312DF 1/4"

- Magnetic screwdriver handle
- DIN 3126



KT NO.	Overall length		g	Box / Kit
	inch	mm		
213312DF	12	300	132	2 / 40

2176DF 1/4"

- 2 in 1 design Spinner handle + Bit holder
- NF ISO 3315, ISO 3315, DIN 3122, ASME B107.10



- Attached with 1/4" bit
- Attached with 1/4"DR. socket
- Easy to switch



- Attached with 1/4"DR. ratchet, compact size & easy to use

KT NO.	Overall length		g	Box / Kit
	inch	mm		
2176DF	6	150	105	6 / 60

2177DF 1/4"

- Spinner handle
- DIN 3122



KT NO.	Overall length		g	Box / Kit
	inch	mm		
2177DF	12-1/4	310	126	6 / 60

2178DF 2179DF 1/4"

- Spinner handle
- DIN 3122



2178DF (PP + TPR)



2179DF (PP)

KT NO.	Overall length		g	Box / Kit
	inch	mm		
2178DF	6	150	76	6 / 120
2179DF	6	150	90	12 / 192

2178TG 1/4"

- Spinner handle
- DIN 3122



KT NO.	mm	mm	g	Box / Kit	
					2178TG

2452 1/4"

- Flexible handle
- Action degree -180°
- DIN 3122



2452DK

KT NO.	Overall length		g	Box / Kit
	inch	mm		
2452-05F	5	130	86	15 / 270
2452DK	renewal kits			

Accessory

KT No. & D1

- Material - chrome vanadium alloy steel
- Finishing - polished, chrome plated & black phosphate sunk

2453

1/4"

- Flexible handle
- Action degree -180°
- New pattern design added in firm and powerful elements
- New forge technologies I-Beam shank offers 15% lightweight
- DIN 3122



2452DK

KT NO.	Overall length inch	mm		
2453-05F	5	130	71	15 / 270
2452DK	renewal kits			

2571

1/4"

- Sliding T-handle
- DIN 3122



KT NO.	Overall length inch	mm		
2571-45	4-1/2	115	44	12 / 192

2141

- Bit holder
- DIN 3122



2141



2142

KT NO.	Size inch	Overall length mm		
2141	1/4	25	14.0	20 / 320
2142	1/4	25	15	20 / 320

Socket Rail Set

2509MR

1/4"

- Socket rail 150mmL



9 PC.

Contents		
2335M 4, 5, 6, 7, 8, 9, 10, 11, 13	0.17	4 / 48
8720609		

2509SR

1/4"

- Socket rail 150mmL



9 PC.

Contents		
2335S 5/32, 3/16, 1/4, 9/32, 5/16, 11/32, 3/8, 7/16, 1/2	0.17	4 / 48
8720609		

Socket Rail Set

2513MR

1/4"

- Socket rail 240 mmL



13 PC.

Contents		
2335M 4, 4.5, 5, 5.5, 6, 7, 8, 9, 10, 11, 12, 13, 14	0.23	6 / 60
8721114		

2513MRD1

1/4"

- Socket rail 508 mmL



13 PC.

Contents		
2335M 4, 4.5, 5, 5.5, 6, 7, 8, 9, 10, 11, 12, 13, 14	0.34	50
8720813D1		

2311MR

1/4"

- Socket rail 240 mmL



13 PC.

Contents		
2235M 4, 4.5, 5, 5.5, 6, 7, 8, 9, 10, 11, 12, 13, 14	0.46	6 / 60
8721114		

2127PR

1/4"

- Socket rail 130mmL
- For hex head screw
- H : 37mm



7 PC.

Contents		
2035 H3, H4, H5, H6, H7, H8, H10	0.15	4 / 32
8720507		

2127SR

1/4"

- Socket rail 130mmL
- For hex head screw
- H : 37mm



7 PC.

Contents		
2035S H1/8, H5/32, H3/16, H7/32, H1/4, H5/16, H3/8	0.15	4 / 32
8720507		



Socket Rail Set

2109PR

1/4"

- Socket rail 150mmL
- For torx head screw
- H : 37mm

9 PC.



Contents 0.12 4 / 32

	2033	T8, T9, T10, T15, T20, T25, T27, T30, T40
8720609		

2114TR

1/4"

- Socket rail 150mmL
- For torx head screw
- H : 37mm

14 PC.



Contents 0.30 6 / 72

	2033	T8, T9, T10, T15, T20, T25, T27, T30, T40
	2275M	E4, E5, E6, E7, E8
8721114		

2107PR

1/4"

- Socket rail 130mmL
- For tamper resistant torx head screw
- H : 37mm

7 PC.



Contents 0.12 4 / 32

	2037	T10H, T15H, T20H, T25H, T27H, T30H, T40H
8720507		

2119PR

1/4"

- Socket rail 150mmL
- For tamper resistant torx head screw
- H : 37mm

9 PC.



Contents 0.12 4 / 32

	2037	T8H, T9H, T10H, T15H, T20H, T25H, T27H, T30H, T40H
8720609		

872

1/4"

- Rail length from 160 mm to 560 mm



KT NO.	L (mm)
870406	160
870208	200
870422	560
8720	-

8720813D1

1/4"

Socket rail carrier with retaining clip
446mm roller cabinet



KT NO.	Square drive	Clip	L (mm)
8720813D1	1/4"	13	508

Extension Bar Set

2104PR

1/4"



4 PC.

Contents 0.17 1 / 80

	2221	2", 3", 4", 6"
--	------	----------------

Socket Set

2313MR

1/4"



13 PC.

Contents 0.42 1 / 32

	2335M	4, 5, 6, 7, 8, 9, 10, 11, 12, 13, 14
	2766-55G	
	2221-04	

2510SR

1/4"

Metal case size (mm) :
223 x 65 x 32 (0.016 cuft)

10 PC.

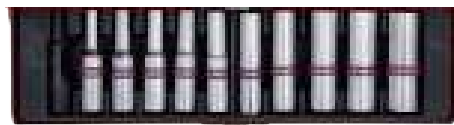

Contents 0.62 1 / 30

	2235S	5/32, 3/16, 7/32, 1/4, 9/32, 5/16, 11/32, 3/8, 7/16, 1/2
--	-------	--

2511MR

1/4"

Metal case size (mm) :
223 x 65 x 32 (0.016 cuft)

11 PC.

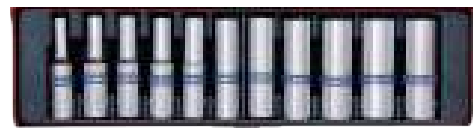

Contents 0.67 1 / 30

	2235M	4, 5, 5.5, 6, 7, 8, 9, 10, 11, 12, 13
--	-------	---------------------------------------

Atom Series

Asymmetrical line design

2539MR-AM

Plastic case size (mm) :
170 x 95 x 51 (0.029 cuft)

39
PC.

PAT.



▪ Push mechanism

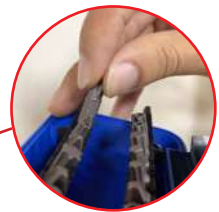
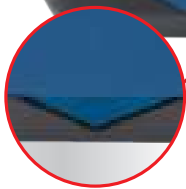

▪ Easy to pick up

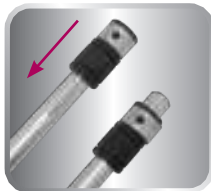

Contents

0.86 1 / 24

		2335M	5, 5.5, 6, 7, 8, 9, 10, 11, 12, 13, 14
		1025P	PH1, PH2, PH3
		102512P	
		1025Z	PZ1, PZ2, PZ3
		1025U	T10H, T15H, T20H, T25H, T27H, T30H, T40H
		1025S	4.0, 5.0, 6.0
		1025H	H2.5, H3, H4, H5, H6
		2773-55GS	
		2141	
			2221-02 2221-04



▪ Automatic raising bit rack



▪ Built-in rotation axis design



Socket Set

2516MR

2516SR

1/4"

Metal case size (mm):
244 x 118 x 37 (0.038 cuft)

16
PC.

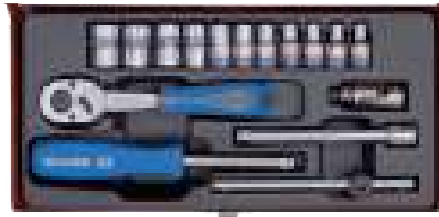

2516MR

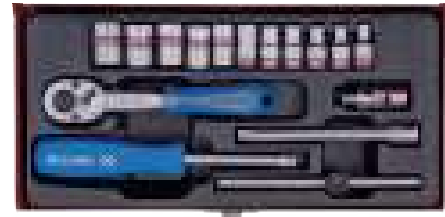

2516SR

KT NO.	Contents		1.10	1 / 18
2516MR	2335M	4, 4.5, 5, 5.5, 6, 7, 8, 9, 10, 11, 13	2779-55G	2571-45
2516SR	2335S	5/32, 3/16, 7/32, 1/4, 9/32, 5/16, 11/32, 3/8, 7/16, 15/32, 1/2	2221-04	2179DF

2518MR

2518SR

2518MR01

1/4"

Metal case size (mm):
198 x 105 x 32 (0.023 cuft)

18
PC.



2518MR/2518MR01



2518SR

KT NO.	Contents		0.96	1 / 20
2518MR	2335M	4, 4.5, 5, 6, 7, 8, 9, 10, 11, 12	2452-05F	2571-45
2518SR	2335S	5/32, 3/16, 7/32, 1/4, 9/32, 5/16, 11/32, 3/8, 7/16, 1/2	2725-55F	2792
2518MR01	2335M	4, 4.5, 5, 5.5, 6, 7, 8, 9, 10, 11, 12, 13	2221-02	2221-04

2019MR

2019SR

2519MR

2519SR

1/4"

Metal case size (mm):
198 x 105 x 32 (0.023 cuft)

18
PC.



2019MR/2519MR



2019SR/2519SR

KT NO.	Contents		0.92	1 / 20
2019MR	2330M	4, 4.5, 5, 6, 7, 8, 9, 10, 11, 12	2769-55P	2452-05F
2519MR	2335M		2221-02	2571-45
2019SR	2330S	5/32, 3/16, 7/32, 1/4, 9/32, 5/16, 11/32, 3/8, 7/16, 1/2	2221-04	
2519SR	2335S		2792	







Socket Set

2021MR

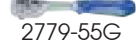
2521MR

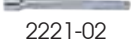
1/4"

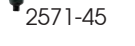
Metal case size (mm) :
198 x 105 x 32 (0.023 cuft)

KT NO.	Contents	Kg 0.87	1 / 20
2021MR	 2330M 4, 4.5, 5, 5.5, 6, 7, 8, 9, 10, 11, 12, 13	 2779-55G  2452-05F  2792	 2221-02  2221-04  2571-45  2141
2521MR	 2335M		









19 PC.

2525MRE

1/4"

Blow case size (mm) :
203 x 93 x 43 (0.028cuft)

Contents	Kg 0.54	1 / 20
 2335M 4, 4.5, 5, 5.5, 6, 7, 8, 9, 10, 11, 12, 13		
 1025P PH2 x2		
 1025H H5, H6		
 1025T T10, T15, T20, T25, T30, T40		
 2771-55G  2221-04  2142		



25 PC.

2027MRE

1/4"

Blow case size (mm) :
203 x 93 x 43 (0.028cuft)











2527MRE

1/4"

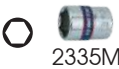

27 PC.

KT NO.	Contents	Kg 0.60	1 / 20
2027MRE	 2330M 4, 4.5, 5, 5.5, 6, 7, 8, 9, 10, 12, 13, 14	 PH1, PH2 1025P  H3, H4, H5 1025H  T10, T15, T20, T25, T30, T40 1025T	 2221-04  276A-04G  2142  2792
2527MRE	 2335M		

Socket Set

2526MR

Metal case size (mm) :
244 x 118 x 37 (0.038 cuft)



2526MR

2526SR

1/4"



2526SR

26
PC.

KT NO.

Contents

1.30 Kg 1 / 18

KT NO.	Contents	1.30 Kg 1 / 18
2526MR	2335M 4, 4.5, 5, 5.5, 6, 7, 8, 9, 10, 11, 13	2779-55G 2221-02 2221-04
	2235M 4, 5, 5.5, 6, 7, 8, 9, 10, 11, 13	
2526SR	2335S 5/32, 3/16, 7/32, 1/4, 9/32, 5/16, 11/32, 3/8, 7/16, 15/32, 1/2	2792 2813
	2235S 5/32, 3/16, 7/32, 1/4, 9/32, 5/16, 11/32, 3/8, 7/16, 1/2	

2031MR

Metal case size (mm) :
280 x 130 x 41 (0.053 cuft)

KT NO.

Contents

1.60 Kg 1 / 15

KT NO.	Contents	1.60 Kg 1 / 15
2031MR	2330M 4, 4.5, 5, 6, 7, 8, 9, 10, 11, 12, 13	2033 T8, T9, T10, T15, T20, T25, T27, T30 2035 H3, H4, H5, H6, H8, H10 2779-55G 2221-03 2221-06 2179DF 2571-45 2792
2531MR	2335M	

2531MR

1/4"



31
PC.

2030CR

Metal case size (mm) :
244 x 118 x 37 (0.038 cuft)



30
PC.

2530CR 1/4"

2539MR

1/4"

Metal case size (mm) :
280 x 130 x 41 (0.053 cuft)



39
PC.

KT NO.

Contents

1.30 Kg 1 / 18

KT NO.	Contents	1.30 Kg 1 / 18
2030CR	2330M 4, 4.5, 5, 6, 7, 8, 9, 10, 11, 12	2310M 8, 10 2310S 5/16, 3/8 2769-55F 2792 2571-45 2452-05F 2221-02 2221-04
	2330S 5/32, 3/16, 7/32, 1/4, 9/32, 5/16, 11/32, 3/8, 7/16, 1/2	
2530CR	2335M 4, 4.5, 5, 6, 7, 8, 9, 10, 11, 12	2335S 5/32, 3/16, 7/32, 1/4, 9/32, 5/16, 11/32, 3/8, 7/16, 1/2
	2335S	

Contents

1.61 Kg 1 / 15

KT NO.	Contents	1.61 Kg 1 / 15
2539MR	2335M 4, 4.5, 5, 5.5, 6, 7, 8, 9, 10, 11, 12, 13 2375M E4, E5, E6, E7, E8 2033 T8, T9, T10, T15, T20, T25, T27, T30, T40 2035 H3, H4, H5, H6, H7, H8, H10 2779-55G 2179DF 2571-45 2221-02 2221-04 2792	

Socket Set

2540MR

1/4"

Metal case size (mm):
316 x 104 x 40 (0.047 cuft)

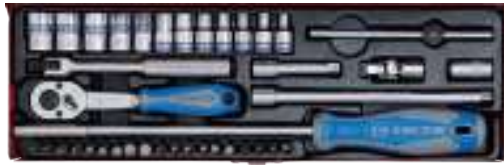

39
PC.

Contents 1.52 1 / 12

	2335M	4, 4.5, 5, 5.5, 6, 7, 8, 9, 10, 11, 12, 13
	1025S	4, 5.5, 7
	1025P	PH0, PH1, PH2, PH3
	1025H	H3, H4, H5, H6, H7, H8
	1025T	T10, T15, T20, T25, T30, T40
	2779-55G	213312DF 2792 2141
	2571-45	2452-05F 2221-02 2221-06

2575MR

1/4"

Metal case size (mm):
244 x 118 x 37 (0.038 cuft)



45
PC.

Contents 1.24 1 / 18

	2335M	4, 5, 5.5, 6, 7, 8, 9, 10, 11, 12, 13, 14
	1025S	4, 6.5, 7, 8
	1025P	PH1, PH2, PH3
	1025H	H2.5, H3, H4, H5, H6, H7, H8, H10
	1025U	T8H, T9H, T10H, T15H, T20H, T25H, T27H, T30H, T40H
	1025Z	PZ1, PZ2, PZ3
	2755-55G	2223-02 2792
	2311-06	2179DF 2142

2551MR

Metal case size (mm):
244 x 118 x 37 (0.038 cuft)



2551MR



2551MR01

51
PC.

KT NO.

Contents

1.30 1 / 18

2551MR	2755-55G	2335M 4, 5, 5.5, 6, 7, 8, 9, 10, 11, 12, 13, 14	1025U T10H, T15H, T20H, T25H, T27H, T30H, T40H	2813 2142 2792
		1025S 3, 4, 5, 6	1025Z PZ1, PZ2 x2, PZ3	7702-25 753-63
2551MR01	2761-55F	1025P PH1, PH2 x2, PH3	1025T T10, T15, T20, T25, T27, T30, T40	2223-02 2178DF 2223-04
		1025H H3, H4, H5, H6		

2516MRV03

Plastic case size (mm):
199 x 161 x 56 (0.063 Cuft)

Tray category #11 (187 x 140mm) 1/4"

Contents 0.75 1 / 16

	2335M	4, 4.5, 5, 5.5, 6, 7, 8, 9, 10, 11, 12, 13, 14
	2771-55G	2571-45
	2221-06	2792



17
PC.

2524MRV

Plastic case size (mm):
199 x 161 x 56 (0.063 Cuft)

Tray category #11 (187 x 140mm) 1/4"

Contents 0.9 1 / 16

	2335M	4, 4.5, 5, 5.5, 6, 7, 8, 9, 10, 11, 12, 13, 14
	2771-55G	2571-45 2142
	2221-02	2221-04 2178DF 2792
	2221-06	



21
PC.

Socket Set

2528MRV

Tray category #11 (187 x 140mm) 1/4"

Plastic case size (mm) :
199x 161 x 56 (0.063 Cuft)

Contents

0.76 1 / 6

○	2335M	4, 4.5, 5, 5.5, 6, 7, 8, 9, 10, 11, 12, 13, 14
●	1025H	H3, H4, H5, H6
⊖	1025S	4, 5
⊕	1025T	T10, T15, T20, T30
⊕	1025P	PH1, PH2
276A-04G 2792 2221-06 2142		



29 PC.

2331SRV

Tray category #7 (280 x 187mm) 1/4"

Plastic case size (mm) :
289 x 230 x 66 (0.154Cuft)

Contents

1.63 1 / 6

○	2335S	5/32, 3/16, 7/32, 1/4, 9/32, 5/16, 11/32, 3/8, 7/16, 15/32, 1/2, 9/16
○	2235S	5/32, 3/16, 7/32, 1/4, 9/32, 5/16, 11/32, 3/8, 7/16, 1/2, 9/16
2771-55G 2571-45 2142		
2221-02 2221-04 2221-06 2792 2178DF		



31 PC.

2534MRV

Tray category #7 (280 x 187mm) 1/4"

Plastic case size (mm) :
289 x 230 x 66 (0.154Cuft)

Contents

1.76 1 / 6

○	2335M	4, 4.5, 5, 5.5, 6, 7, 8, 9, 10, 11, 12, 13, 14
○	2235M	4, 4.5, 5, 5.5, 6, 7, 8, 9, 10, 11, 12, 13, 14
2771-55G 2571-45 2142		
2221-02 2221-04 2221-06 2178DF 2792		



34 PC.

2565MRV

Tray category #7 (280 x 187mm) 1/4"

Plastic case size (mm) :
289 x 230 x 66 (0.154 cuft)

Contents

2.67 1 / 6

○	2335M	4, 4.5, 5, 5.5, 6, 7, 8, 9, 10, 11, 12, 13, 14
○	2235M	4, 4.5, 5, 5.5, 6, 7, 8, 9, 10, 11, 12, 13, 14
⊕	2375M	E4, E5, E6, E7, E8
⊕	2013X	T8, T9, T10, T15, T20, T25, T27, T30, T40
●	2015X	3, 4, 5, 6, 8
⊕	2018X	PZ1, PZ2
⊕	2011X	PH1, PH2
⊖	2012X	3.5, 5.5, 8
⊕	1025T	T6, T7
●	1025M	M4, M5, M6, M8, M10



65 PC.

Contents

2792	2813	276A-04G	2221-02
			2221-04
			2221-06

Socket Set

2044SRV

Plastic case size (mm) :
389 x 185 x 66 (0.168 Cuft)



2044SRV

2544SRV Tray category #10 (375 x 140mm) 1/4"

44
PC.



2544SRV

KT NO.	Contents		1.62 kg	1 / 10
2044SRV	2330S	5/32, 3/16, 7/32, 1/4, 9/32, 5/16, 11/32, 3/8, 7/16, 15/32, 1/2	2142 2792 2223-02 2223-04 2752-06G 2178DF	
2544SRV	2335S	5/32, 3/16, 7/32, 1/4, 9/32, 5/16, 11/32, 3/8, 7/16, 15/32, 1/2	2142 2792 2223-02 2223-04 2752-06G 2178DF	

2048MRV

Plastic case size (mm) :
389 x 185 x 66 (0.168 Cuft)



2048MRV

2548MRV Tray category #10 (375 x 140mm) 1/4"

48
PC.



2548MRV

KT NO.	Contents		1.79 kg	1 / 10
2048MRV	2330M	4, 4.5, 5, 5.5, 6, 7, 8, 9, 10, 11, 12, 13, 14	2142 2792 2223-02 2223-04 2178DF 2752-06G	
2548MRV	2335M	4, 4.5, 5, 5.5, 6, 7, 8, 9, 10, 11, 12, 13, 14	2142 2792 2223-02 2223-04 2178DF 2752-06G	

Socket Set

2553MRV

Plastic case size (mm) :
389 x 185 x 66 (0.168 Cuft)

Tray category #10 (375 x 140mm) 1/4"

Contents

1.67 kg 1 / 10

2335M	4, 5, 5.5, 6, 7, 8, 9, 10, 11, 12, 13, 14
1025H	H3, H4, H5, H6, H7, H8, H10
1025S	3, 4.5, 5, 6.5, 8
1025P	PH0, PH1, PH2, PH3
1025U	T10H, T15H, T20H, T25H, T27H, T30H, T40H
1025Z	PZ1, PZ2, PZ3
1025T	T10, T15, T20, T25, T27, T30, T40
7702-25	2792 2813



53
PC.

Contents

276A-04G	213312DF
2223-02	2745
2223-04	

2553MRV01

Tray category #10 (375 x 140mm) 1/4"

Plastic case size (mm) :
389 x 185 x 66 (0.168 Cuft)

Contents

1.87 1/10

	2335M	4, 4.5, 5, 5.5, 6, 7, 8, 9, 10, 11, 12, 13, 14
	1025H	H3, H4, H5, H6, H7, H8, H10
	1025T	T10, T15, T20, T25, T27, T30, T40
	1025U	T10H, T15H, T20H, T25H, T27H, T30H, T40H
	1025P	PH1, PH2, PH3
	1025Z	PZ1, PZ2, PZ3
	1025S	3, 4.5, 5, 6.5, 8
	7702-25	
	276A-04G	

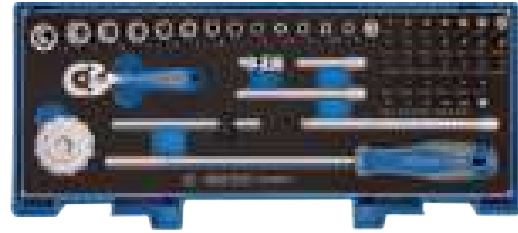

55 PC.

Contents

	2571-45		213312DF
	2221-02		2745
	2221-04		2792
	2221-06		2142

2550MRV

Tray category #8 (375 x 187mm) 1/4"

Plastic case size (mm) :
389 x 230 x 66 (0.208 Cuft)

Contents

2.2 1/6

	2335M	4, 4.5, 5, 5.5, 6, 7, 8, 9, 10, 11, 12, 13, 14	
	2375M	E4, E5, E6, E7, E8	
	2031	PH1, PH2, PH3, PH4	
	2032	4, 5.5, 6.5, 8, 10	
	2033	T8, T9, T10, T15, T20, T25, T27, T30, T40	
	2035	H3, H4, H5, H6, H7, H8, H10	
	2771-55G		2178DF
	2571-45		2792
	2293-04		2221-02
	2293-06		



50 PC.

2549MR-EB

Contents

1.28 1/12

	2335M	4, 4.5, 5, 5.5, 6, 7, 8, 9, 10 x2, 11, 12, 13, 14
	2235M	4, 4.5, 5, 5.5, 6, 7, 8, 9, 10, 11, 12, 13, 14
	2275M	E4, E5, E6, E7, E8
	2375M	E4, E5, E6, E7, E8, E10
	2031	PH1, PH2
	2032	4, 5.5
	2035	H3, H4, H5, H6, H8
	2221-02	



49 PC.



Standard Socket

3330M

- Metric-DIN 3124, ISO 2725-1
- Inch-ANSI / ASME B107.1

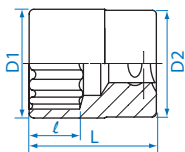

KT NO.	mm	D1 mm	D2 mm	l mm	L mm	⚖	📦
333006M	6	9.9	17.8	7.0	27	25	12 / 360
333007M	7	10.8	17.8	7.0	27	24	12 / 360
333008M	8	12.0	17.8	7.0	27	25	12 / 360
333009M	9	13.2	17.8	7.0	27	25	12 / 360
333010M	10	14.5	17.8	9.0	27	26	12 / 360
333011M	11	15.8	17.8	9.0	27	27	12 / 360
333012M	12	16.8	17.8	9.0	27	26	12 / 360
333013M	13	17.8	16.8	9.0	27	25	12 / 360
333014M	14	19.7	18.0	11.0	29	33	10 / 300
333015M	15	20.8	18.0	11.0	29	35	10 / 300
333016M	16	21.8	20.0	11.0	29	45	10 / 300
333017M	17	23.8	20.0	11.0	29	48	10 / 200
333018M	18	24.7	21.0	13.0	29	50	10 / 200
333019M	19	25.8	21.0	13.0	29	51	10 / 200
333020M	20	27.1	25.0	13.0	32	83	10 / 160
333021M	21	27.8	25.0	13.0	32	80	10 / 160
333022M	22	29.7	26.0	15.0	32	86	10 / 160
333023M	23	29.7	26.0	15.0	32	80	10 / 160
333024M	24	31.8	26.0	17.0	32	89	8 / 160

KT NO.	inch	D1 mm	D2 mm	l mm	L mm	⚖	📦
333008S	1/4	10.0	17.8	7.0	27	24	12 / 360
333010S	5/16	12.0	17.8	7.0	27	24	12 / 360
333011S	11/32	13.2	17.8	7.0	27	25	12 / 360
333012S	3/8	14.0	17.8	9.0	27	26	12 / 360
333014S	7/16	15.8	17.8	9.0	27	26	12 / 360
333015S	15/32	16.8	17.8	9.0	27	27	12 / 360
333016S	1/2	17.8	16.8	9.0	27	26	12 / 360
333018S	9/16	19.7	18.0	11.0	29	33	10 / 300
333019S	19/32	20.8	18.0	11.0	29	35	10 / 300
333020S	5/8	21.8	20.0	11.0	29	42	10 / 300
333022S	11/16	23.8	20.0	11.0	29	46	10 / 200
333024S	3/4	25.8	21.0	13.0	29	50	10 / 200
333026S	13/16	27.8	25.0	13.0	32	80	10 / 160
333028S	7/8	29.7	26.0	15.0	32	83	10 / 160
333030S	15/16	31.8	26.0	17.0	34	83	8 / 160
333032S	1	33.8	26.0	17.0	34	96	8 / 160

3335M

- Metric-DIN 3124, ISO 2725-1
- Inch-ANSI / ASME B107.1

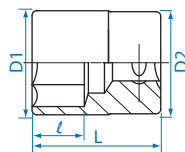

KT NO.	mm	D1 mm	D2 mm	l mm	L mm	⚖	📦
333506M	6	9.9	17.8	7.0	27	25	12 / 360
333507M	7	10.8	17.8	7.0	27	24	12 / 360
333508M	8	12.0	17.8	7.0	27	26	12 / 360
333509M	9	13.2	17.8	7.0	27	25	12 / 360
333510M	10	14.5	17.8	9.0	27	28	12 / 360
333511M	11	15.8	17.8	9.0	27	27	12 / 360
333512M	12	16.8	17.8	9.0	27	28	12 / 360
333513M	13	17.8	16.8	9.0	27	26	12 / 360
333514M	14	19.7	18.0	11.0	29	35	10 / 300
333515M	15	20.8	18.0	11.0	29	39	10 / 300
333516M	16	21.8	20.0	11.0	29	43	10 / 300
333517M	17	23.8	20.0	11.0	29	50	10 / 200
333518M	18	24.7	21.0	13.0	29	51	10 / 200
333519M	19	25.8	21.0	13.0	29	53	10 / 200
333520M	20	27.1	25.0	13.0	32	87	10 / 160
333521M	21	27.8	25.0	13.0	32	82	10 / 160
333522M	22	29.7	26.0	15.0	32	89	10 / 160
333523M	23	29.7	26.0	15.0	32	84	10 / 160
333524M	24	31.8	26.0	17.0	32	94	8 / 160

KT NO.	inch	D1 mm	D2 mm	l mm	L mm	⚖	📦
333508S	1/4	10.0	17.8	7.0	27	24	12 / 360
333510S	5/16	12.0	17.8	7.0	27	25	12 / 360
333511S	11/32	13.2	17.8	7.0	27	24	12 / 360
333512S	3/8	14.0	17.8	9.0	27	25	12 / 360
333514S	7/16	15.8	17.8	9.0	27	25	12 / 360
333515S	15/32	16.8	17.8	9.0	27	27	12 / 360
333516S	1/2	17.8	16.8	9.0	27	26	12 / 360
333518S	9/16	19.7	18.0	11.0	29	32	10 / 300
333519S	19/32	20.8	18.0	11.0	29	35	10 / 300
333520S	5/8	21.8	20.0	11.0	29	43	10 / 300
333522S	11/16	23.8	20.0	11.0	29	48	10 / 200
333524S	3/4	25.7	21.0	13.0	29	51	10 / 200
333526S	13/16	27.8	25.0	13.0	32	83	10 / 160
333528S	7/8	29.6	26.0	15.0	32	89	10 / 160
333530S	15/16	31.8	26.0	17.0	34	86	8 / 160
333532S	1	33.8	26.0	17.0	34	101	8 / 160

Thin Wall Deep Socket

3215M

- Specifically for heat plug, glow plug

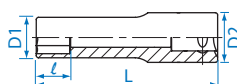

Thin walled design (D1)

KT NO.	mm	D1 mm	D2 mm	l mm	L mm	⚖	📦
321510M	10	13.0	17.8	12.0	65	49	20 / 240
321512M	12	15.0	17.8	15.0	65	49	20 / 240



Deep Socket

3230M

- Metric-DIN 3124, ISO 2725-1
- Inch-ANSI / ASME B107.1

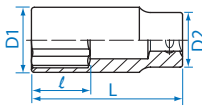

3230S $\text{\textcircled{3/8}}$ "



3235M

- Metric-DIN 3124, ISO 2725-1
- Inch-ANSI / ASME B107.1

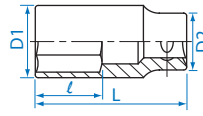

3235S $\text{\textcircled{3/8}}$ "



KT NO.	$\text{\textcircled{mm}}$	D1 mm)	D2 (mm)	l (mm)	L (mm)		
323007M	7	10.8	17.8	10.0	63	55	20 / 320
323008M	8	12.0	17.8	12.0	63	49	18 / 288
323009M	9	13.2	17.8	12.0	63	57	18 / 288
323010M	10	14.5	17.8	12.0	63	57	15 / 240
323011M	11	15.8	17.8	15.0	63	57	15 / 240
323012M	12	16.8	17.8	15.0	63	58	15 / 240
323013M	13	17.8	16.8	15.0	63	57	15 / 240
323014M	14	19.7	18.0	16.0	63	73	12 / 192
323015M	15	20.8	18.0	18.0	63	73	10 / 160
323016M	16	21.8	20.0	18.0	63	87	8 / 128
323017M	17	23.8	20.0	18.0	63	101	8 / 128
323018M	18	24.7	21.0	20.0	63	107	6 / 96
323019M	19	25.8	21.0	20.0	63	113	6 / 96
323021M	21	27.8	25.0	20.0	63	122	6 / 96
323022M	22	29.7	26.0	20.0	63	150	6 / 96
323024M	24	31.8	26.0	25.0	63	158	6 / 120

KT NO.	$\text{\textcircled{mm}}$	D1 mm)	D2 mm)	l mm)	L mm)		
323506M	6	9.9	17.8	10.0	63	51	20 / 320
323507M	7	10.8	17.8	10.0	63	52	20 / 320
323508M	8	12.0	17.8	12.0	63	49	18 / 288
323509M	9	13.2	17.8	12.0	63	53	18 / 288
323510M	10	14.5	17.8	12.0	63	58	15 / 240
323511M	11	15.8	17.8	15.0	63	60	15 / 240
323512M	12	16.8	17.8	15.0	63	68	15 / 240
323513M	13	17.8	16.8	15.0	63	64	15 / 240
323514M	14	19.7	18.0	16.0	63	77	12 / 192
323515M	15	20.8	18.0	18.0	63	75	10 / 160
323516M	16	21.8	19.0	18.0	63	86	8 / 128
323517M	17	23.8	20.0	18.0	63	102	8 / 128
323518M	18	24.7	21.0	20.0	63	112	6 / 96
323519M	19	25.8	21.0	20.0	63	111	6 / 96
323521M	21	27.8	25.0	20.0	63	142	6 / 96
323522M	22	29.7	26.0	20.0	63	167	6 / 96
323524M	24	31.8	26.0	25.0	63	171	6 / 120

KT NO.	$\text{\textcircled{inch}}$	D1 mm)	D2 mm)	l mm)	L mm)		
323008S	1/4	10.0	16.8	10.0	63	48	20 / 320
323010S	5/16	12.0	17.8	12.0	63	48	18 / 288
323012S	3/8	14.0	17.8	12.0	63	53	15 / 240
323014S	7/16	15.8	17.8	15.0	63	54	15 / 240
323016S	1/2	17.8	16.8	15.0	63	58	15 / 240
323018S	9/16	19.7	18.0	16.0	63	74	12 / 192
323020S	5/8	21.8	20.0	18.0	63	88	8 / 128
323022S	11/16	23.8	20.0	18.0	63	98	8 / 128
323024S	3/4	25.8	21.0	20.0	63	111	6 / 96
323026S	13/16	27.8	25.0	20.0	63	125	6 / 96
323028S	7/8	29.7	26.0	21.0	63	158	6 / 96
323030S	15/16	31.8	26.0	22.0	63	170	5 / 80
323032S	1	33.8	26.0	22.0	63	195	5 / 80

KT NO.	$\text{\textcircled{inch}}$	D1 mm)	D2 mm)	l mm)	L mm)		
323508S	1/4	10.0	16.8	10.0	63	47	20 / 320
323510S	5/16	12.0	17.8	12.0	63	56	18 / 288
323512S	3/8	14.0	17.8	12.0	63	56	15 / 240
323514S	7/16	15.8	17.8	15.0	63	59	15 / 240
323516S	1/2	17.8	16.8	15.0	63	41	15 / 240
323518S	9/16	19.7	18.0	16.0	63	76	12 / 192
323520S	5/8	21.8	20.0	18.0	63	90	8 / 128
323522S	11/16	23.8	20.0	18.0	63	97	8 / 128
323524S	3/4	25.8	21.0	20.0	63	108	6 / 96
323526S	13/16	27.8	25.0	20.0	63	146	6 / 96
323528S	7/8	29.7	26.0	21	63	166	6 / 96
323530S	15/16	31.8	26.0	22	63	182	5 / 80
323532S	1	33.8	26.0	22	63	206	5 / 80



Star Socket

KT No. & D1



3375M

3/8"

- DIN 3120

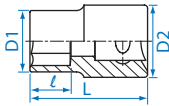

KT NO.	Size	D1 mm	D2 mm	ℓ mm	L mm	⚖️	📦
337504M	E4	6.0	16.8	3.6	28	21	12 / 360
337505M	E5	7.0	16.8	4.0	28	21	12 / 360
337506M	E6	8.0	16.8	5.0	28	22	12 / 360
337507M	E7	8.9	16.8	6.0	28	22	12 / 360
337508M	E8	10.0	16.8	6.5	28	23	12 / 360
337510M	E10	12.0	16.8	7.0	28	24	12 / 360
337511M	E11	12.8	16.8	8.0	28	24	12 / 360
337512M	E12	14.3	16.8	9.0	28	26	12 / 360
337514M	E14	15.9	17.8	9.5	28	31	12 / 360
337516M	E16	18.0	19.8	10.5	28	42	10 / 300
337518M	E18	20.0	21.8	11.0	28	55	10 / 300

3275M

3/8"

- DIN 3120

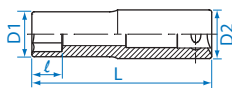

KT NO.	Size	D1 mm	D2 mm	ℓ mm	L mm	⚖️	📦
327504M	E4	6.0	16.8	3.6	63	45	12 / 240
327505M	E5	7.0	16.8	4.0	63	47	12 / 240
327506M	E6	8.0	16.8	5.0	63	48	12 / 240
327507M	E7	8.9	16.8	6.0	63	49	12 / 240
327508M	E8	10.0	16.8	6.5	63	52	12 / 240
327510M	E10	12.0	16.8	7.0	63	57	12 / 240
327511M	E11	12.8	16.8	8.0	63	59	12 / 240
327512M	E12	14.3	16.8	9.0	63	65	12 / 240
327514M	E14	15.9	16.8	9.5	63	67	12 / 240
327516M	E16	17.8	17.8	10.5	63	77	12 / 240
327518M	E18	19.8	19.8	11.0	63	100	10 / 160

333E

3/8"

- For torx plus external screw
- DIN 3120

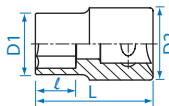

KT NO.	Size	D1 mm	D2 mm	ℓ mm	L mm	⚖️	📦
333E10M	EP10	13.2	10.5	8	37	53	20 / 240
333E11M	EP11	14.0	11.0	9	37	53	20 / 240
333E12M	EP12	14.6	12.0	10	37	53	20 / 240
333E14M	EP14	16.5	14.0	11	37	55	20 / 240
333E16M	EP16	19.0	16.0	12	37	59	20 / 240
333E18M	EP18	20.3	18.0	15	37	60	20 / 240
333E20M	EP20	21.8	19.5	15	37	63	20 / 240





KING TONY Spark Plug Sockets								
Square drive	Type	Size / KT NO.		Rubber I	Magnet	Rubber II	Metal clip	Spring
		Inch	mm					
3/8"	6PT		14	36B014				
			14	36B514				
		5/8"	16	363516	366516		367516	
			18				367518	
	12PT	13/16"	20.8	363521	366521		367521	
			14			36C014		36A014
			14			36D014		
		5/8"	16	363016				
			18	36B018			367018	
		13/16"	20.8	363021	366021		367021	
1/2"	6PT		14	463514RC			467514C	
		5/8"	16	463516RC	466516C		467516	
		13/16"	20.8	463521RC	466521C		467521	
	12PT		14	463014RC			467014C	
		5/8"	16	463016RC	466016		467016	
		13/16"	20.8	463021RC	466021		467021	

Metal Clip Universal Joint Spark Plug Socket

3650

- Inside sleeve - Metal clip for a firm hold and assembly of the spark plugs
- Universal joint- for working in restricted access and obstructive areas
- 12-point socket enables application on 14mm spark plugs of 6-point and 12-point
- Application: For 14 mm spark plugs e.g. BMW and MERCEDES-BENZ
- DIN 3120

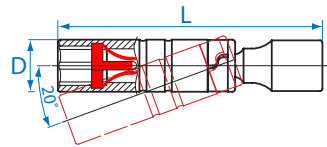

KT NO.	inch	mm	D mm	L mm		
365014B	-	14.0	18.5	155	169	6 / 120
365016A	5/8	16.0	21.0	101	130	6 / 180
365016B	5/8	16.0	21.0	162	185	6 / 120

36A0

36B0

- Inside sleeve - rubber and spring
- DIN 3120
- 36C014 & 36D014 are suitable for BMW, Mini, RENAULT Clio / Twingo / Kangoo type, PEUGEOT 206 1.4 16V, CITROEN C5 HPI

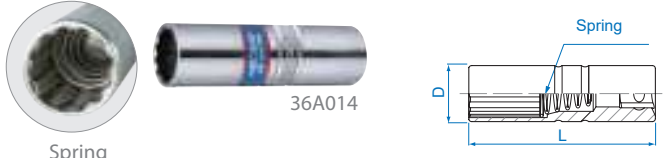

KT NO.	Type	Size mm	D mm	L mm		
36A014	12 points	14.0	18.5	63	65	12 / 192
36B514	6 points	14.0	18.5	63	63	12 / 192
36B014	12 points	14.0	18.5	63	59	12 / 192
36B018	12 points	18.0	24.7	65	104	8 / 128
36C014	12 points	14.0	18.5	90	90	12 / 144
36D014	12 points	14.0	18.5	250	297	6 / 54



Spark Plug Socket

KT No. & D1



3630



3660



3635



3665



3670



3675

3/8"

- 6 / 12 points
- Size combined- 16.0mm (5/8") - 20.8mm (13/16")
- Inside sleeve - rubber / magnet
- DIN 3120



KT NO.	Type	Size		D mm	L mm	Weight (g)	Pcs	Box
		inch	mm					
363016	12 points Rubber	5/8	16.0	21	70	85	10 / 200	
363021	12 points Rubber	13/16	20.8	27.7	70	149	12 / 120	
366021	12 points Magnet	13/16	20.8	27.7	70	149	12 / 120	
363516	6 points Rubber	5/8	16.0	21	70	88	10 / 200	
363521	6 points Rubber	13/16	20.8	27.7	70	153	12 / 120	
366516	6 points Magnet	5/8	16.0	21	70	89	10 / 200	
366521	6 points Magnet	13/16	20.8	27.7	70	155	12 / 120	
367018	12 points Metal clip	-	18.0	23.8	63	84	12 / 120	
367021	12 points Metal clip	13/16	20.8	27.7	70	167	12 / 120	
367516	6 points Metal clip	5/8	16.0	21.0	70	86	10 / 200	
367518	6 points Metal clip	-	18.0	23.8	63	91	12 / 120	
367521	6 points Metal clip	13/16	20.8	27.7	70	169	12 / 120	



363016



363021



366021



363516



366516



363521



366521

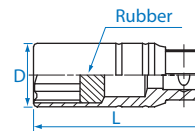

Rubber

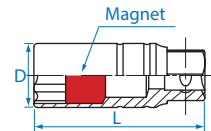

Magnet



367516



367018

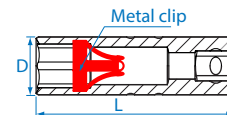

Metal clip

Glow Plug Socket & Set

3785M

3/8"

- The socket has a Sprung-loaded clip with ball bearing end to stop the glow plug from falling out
- Suitable for the removal of glow plugs in most diesel engines



KT NO.	mm	D1 mm	D2 mm	L mm	Weight (g)	Pcs	Box
378508M	8	13.5	17.8	118	131	10 / 100	
378509M	9	13.5	17.8	118	120	10 / 100	
378510M	10	13.5	17.8	118	123	10 / 100	
378512M	12	17.8	17.8	118	147	10 / 100	
378514M	14	17.8	17.8	118	139	10 / 100	
378516M	16	19.8	17.8	118	154	10 / 100	

3716MR

3/8"

Blow case size (mm):
260 x 160 x 64 (0.094 cuft)

6 PC.



Contents

1.23

1 / 10

3785M 8, 9, 10, 12, 14, 16



Flexible Ring Socket Wrench & Set

3350M 

- Flexible head folds up to 200°
- Combined with F-handle, handle, T-handle speed-handle
- Suitable for all hydraulic, fuel, oil brake, A/C, auto tool and air line work
- DIN 3120



KT NO.	mm	D1 mm	D2 mm	L mm	kg	Box
335008M	8	15.0	18.8	45.0	44	12 / 360
335009M	9	18.0	18.8	49.0	48	12 / 360
335010M	10	18.0	18.8	49.0	49	12 / 360
335011M	11	22.0	18.8	53.0	58	12 / 360
335012M	12	22.0	18.8	53.0	58	12 / 360
335013M	13	26.0	18.8	60.0	80	12 / 240
335014M	14	26.0	18.8	60.0	82	12 / 240
335015M	15	27.0	18.8	60.0	80	12 / 240
335016M	16	32.0	24.7	73.5	159	6 / 96
335017M	17	33.0	24.7	73.5	159	6 / 96
335018M	18	33.0	24.7	73.5	156	6 / 96
335019M	19	32.0	24.7	73.5	161	6 / 96

Flexible Crowfoot Socket Wrench & Set

3351M 

- Flexible head folds up to 200°
- Combined with F-handle, handle, T-handle speed-handle
- Suitable for all hydraulic, fuel, oil brake, A/C, auto tool and air line work
- DIN 3120

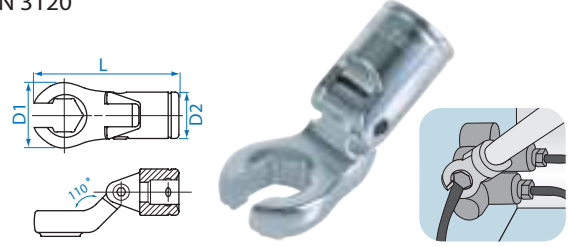

KT NO.	mm	D1 mm	D2 mm	L mm	kg	Box
335108M	8	15.0	18.8	45.0	45	12 / 360
335109M	9	18.0	18.8	49.0	48	12 / 360
335110M	10	18.0	18.8	49.0	49	12 / 360
335111M	11	22.0	18.8	53.0	57	12 / 360
335112M	12	22.0	18.8	53.0	57	12 / 360
335113M	13	26.0	18.8	60.0	77	12 / 240
335114M	14	26.0	18.8	60.0	76	12 / 240
335115M	15	27.0	18.8	60.0	76	12 / 240
335116M	16	32.0	24.7	73.5	153	6 / 96
335117M	17	33.0	24.7	73.5	152	6 / 96
335118M	18	33.0	24.7	73.5	150	6 / 96
335119M	19	33.3	24.7	73.5	153	6 / 96

3609MR10 

- Socket rail 290mmL



Contents  0.99  20

  3350M 8, 10, 12, 13, 14, 16, 17, 18, 19

8731109

3619MR10 

- Socket rail 290mmL



Contents  0.89  20

  3351M 8, 10, 12, 13, 14, 16, 17, 18, 19

8731109

3612MR 

Metal case size (mm):
296 x 130 x 41 (0.056 cuft)

Contents  1.89  1 / 10

  3351M 8, 9, 10, 11, 12, 13, 14, 15, 16, 17, 18, 19



12 PC.

Universal Socket & Set

KT No. & D1



3750M

- Chrome vanadium alloy steel
- DIN 3120

KT NO.	mm	D1 mm	D2 mm	ℓ mm	L mm	⚖️	📦
375010M	10	14.5	19	4.6	49.5	56	15 / 240
375011M	11	15.8	19	5.4	50.5	57	15 / 240
375012M	12	17.0	19	6.1	51.0	57	15 / 240
375013M	13	18.3	19	6.7	52.0	56	15 / 240
375014M	14	20.0	19	8.3	52.0	60	12 / 192
375015M	15	22.0	19	8.3	54.5	66	10 / 160
375016M	16	22.0	19	9.5	54.5	63	10 / 160
375017M	17	24.0	19	9.5	55.5	71	8 / 128
375018M	18	26.0	19	10	55.5	75	6 / 96
375019M	19	26.0	19	11	57.5	72	6 / 96

3750S

3/8"

- Chrome vanadium alloy steel

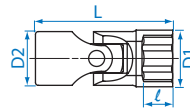

KT NO.	inch	D1 mm	D2 mm	ℓ mm	L mm	⚖️	📦
375012S	3/8	14.0	19	4.6	49.0	56	15 / 240
375014S	7/16	15.8	19	5.4	50.5	58	15 / 240
375016S	1/2	18.3	19	6.7	52.0	59	15 / 240
375018S	9/16	20.0	19	8.3	52.0	60	12 / 192
375020S	5/8	22.0	19	9.5	54.5	65	10 / 160
375022S	11/16	24.0	19	9.5	55.5	65	8 / 128
375024S	3/4	26.0	19	11.0	57.5	74	6 / 96

3709MR10

3/8"

- Socket rail 240mmL



9 PC.

Contents ⚖️ 0.6 📦 14

🔗 3750M 10, 11, 12, 13, 14, 16, 17, 18, 19

8730907

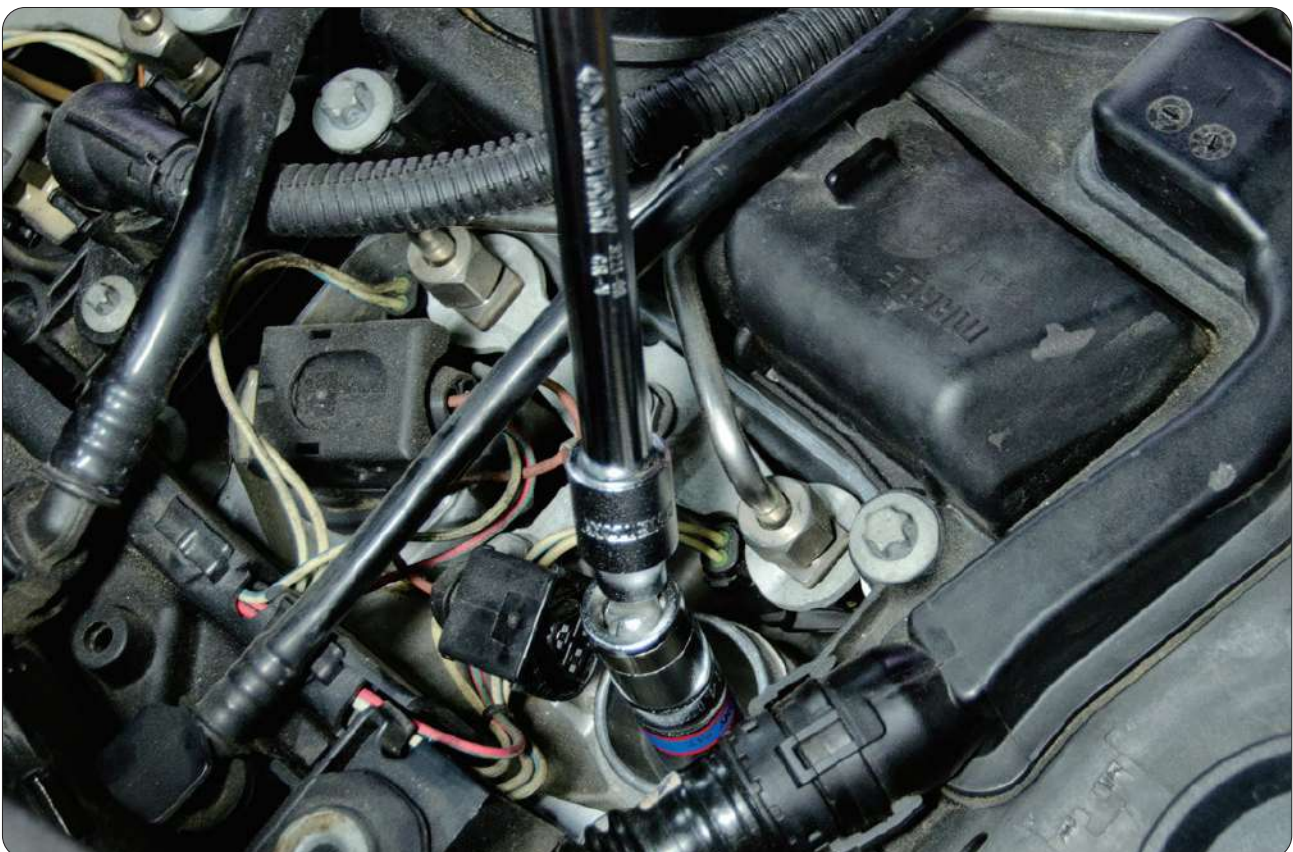

Bit Socket



In order to get normal life of bit socket, always use within limited torque to bit.



3021



- Phillips head
- DIN ISO 8764-1



KT NO.	⊕ No.	Overall length mm		
302102	PH2	50	34	20 / 400
302103	PH3	50	34	20 / 400
302104	PH4	50	34	20 / 400

3022



- Slotted head
- DIN ISO 8764-1



KT NO.	Tip width mm	Tip thickness mm	Overall length mm		
302205	5	1.0	50	34	20 / 400
302208	8	1.2	50	38	20 / 400
302210	10	1.6	50	46	20 / 400

3025



- Hexagon head
- DIN 7422 / 3120



KT NO.	mm	Overall length mm		
302503	H3	50	30	20 / 400
302504	H4	50	34	20 / 400
302505	H5	50	35	20 / 400
302506	H6	50	35	20 / 400
302507	H7	50	39	20 / 400
302508	H8	50	41	20 / 400
302509	H9	50	44	20 / 400
302510	H10	50	50	20 / 400
302512	H12	50	53	20 / 400

3023



- For torx internal screw
- DIN 3120



KT NO.	mm	Overall length mm		
302308	T8	50	30	20 / 400
302309	T9	50	30	20 / 400
302310	T10	50	34	20 / 400
302315	T15	50	34	20 / 400
302320	T20	50	33	20 / 400
302325	T25	50	34	20 / 400
302327	T27	50	34	20 / 400
302330	T30	50	35	20 / 400
302340	T40	50	36	20 / 400
302345	T45	50	39	20 / 400
302350	T50	50	40	20 / 400

3027



- For tamper resistant torx screw
- DIN 3120



KT NO.	mm	Overall length mm		
302708	T8H	50	33	20 / 400
302709	T9H	50	33	20 / 400
302710	T10H	50	33	20 / 400
302715	T15H	50	34	20 / 400
302720	T20H	50	33	20 / 400
302725	T25H	50	34	20 / 400
302727	T27H	50	34	20 / 400
302730	T30H	50	35	20 / 400
302740	T40H	50	35	20 / 400
302745	T45H	50	39	20 / 400
302750	T50H	50	39	20 / 400

3039



- Ribe bit socket
- Use for VW, Audi, Fiat cylinder head bolt
- DIN 3120



KT NO.	size	Overall length mm		
303906	M6	90	70	8 / 160
303907	M7	90	71	8 / 160
303908	M8	90	71	8 / 160
303909	M9	90	88	8 / 160
303910	M10	90	90	8 / 160

302D



- For torx plus tamper screw
- IPR20 for the operation of the screwed connection of the plug-in pump on MERCEDES-BENZ Atego and Actros MAZDA 3 1.4 and 1.6
- IPR25 for the screwed connections at the control unit and the air flow sensor on VW
- DIN 3120



KT NO.	mm	Overall length mm		
302D08	IPR8	50	33	20 / 400
302D09	IPR9	50	33	20 / 400
302D10	IPR10	50	33	20 / 400
302D15	IPR15	50	33	20 / 400
302D20	IPR20	50	34	20 / 400
302D25	IPR25	50	34	20 / 400
302D27	IPR27	50	34	20 / 400
302D30	IPR30	50	35	20 / 400
302D40	IPR40	50	36	20 / 400
302D45	IPR45	50	38	20 / 400
302D50	IPR50	50	40	20 / 400
302D55	IPR55	50	48	20 / 400
302D60	IPR60	50	53	15 / 300

Ratchet

KT No. & D1

3725

FINE GEAR 3/8"

- Reversible ratchet
- 8° gear action degree (45 teeth)
- DIN 3122

KT NO.	Overall length			
	inch	mm		
3725-08F	8	203	369	2 / 40
3725-08G	8	207	384	2 / 32
3725DK	renewal kits		-	-

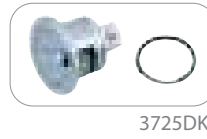

3755

FINE GEAR 3/8"

- Reversible ratchet
- 5° gear action degree (72 teeth)
- DIN 3122

KT NO.	Overall length			
	inch	mm		
3755-08G	8	200	190	2 / 40
3755DK	renewal kits		-	-

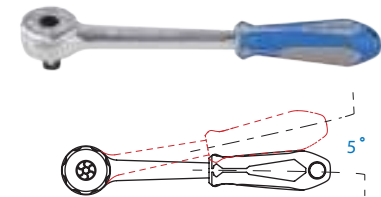

3752

QUICK RELEASE FINE GEAR 3/8"

- Quick release flexible and reversible ratchet
- 5° gear action degree (72 teeth)
- Multi-angle design for difficult-to-reach fasteners



KT NO.	Overall length			
	inch	mm		
3752-09G	9	235	374	2 / 32
3752DK	renewal kits		-	-

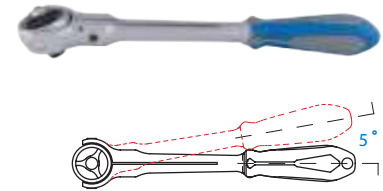

3760

MINI RATCHET FINE GEAR 3/8"

- Mini reversible ratchet
- 5° gear action degree (72 teeth)
- Two teeth pawl action
- DIN 3122

KT NO.	Overall length			
	inch	mm		
3760-45	4-3/8	110	116	6 / 108
3760DK01	renewal kits		-	-



3761

QUICK RELEASE 3/8"

- Quick release reversible ratchet
- 11° gear action degree (32 teeth)
- Two teeth pawl action
- DIN 3122

KT NO.	Overall length			
	inch	mm		
3761-08F	8	200	401	2 / 40
3761-08P	8	200	376	2 / 40
34362-2DK	renewal kits		-	-

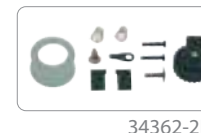

Ratchet



3769

3/8"

- Reversible ratchet
- 11° gear action degree (32 teeth)
- Two teeth pawl action
- DIN 3122

KT NO.	Overall length			
	inch	mm		
3769-08F	8	200	405	2 / 40
3769-08P	8	200	380	2 / 40
3769DK	renewal kits		-	-



3771

QUICK RELEASE 3/8"

- Quick release reversible ratchet
- 11° gear action degree (32 teeth)
- Two teeth pawl action
- DIN 3122

KT NO.	Overall length			
	inch	mm		
3771-08G	8	200	268	2 / 40
3771DK	renewal kits		-	-



3774

3/8"

- Universal joint reversible ratchet
- 11° gear action degree (32 teeth)
- Two teeth pawl action
- DIN 3122
- 15° rotation

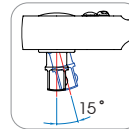

KT NO.	Overall length			
	inch	mm		
3774-08G	8	200	275	2 / 40
3774DK	renewal kits		-	-



3779

3/8"

- Reversible ratchet
- 11° gear action degree (32 teeth)
- Two teeth pawl action
- DIN 3122

KT NO.	Overall length			
	inch	mm		
3779-08F	8	200	366	2 / 40
3779-08G	8	200	273	2 / 40
3779DK	renewal kits		-	-



3781

QUICK RELEASE 3/8"

- Quick release flexible and reversible ratchet
- 11° gear action degree (32 teeth)
- Two teeth pawl action
- DIN 3122

KT NO.	Overall length			
	inch	mm		
3781-11F	11	280	467	2 / 40
3781-11P	11	280	445	2 / 40
3781DK	renewal kits		-	-

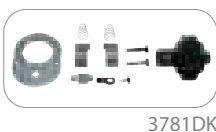

- Material - chrome vanadium alloy steel
- Finishing - polished, chrome plated & black phosphate sunk

Accessory

KT No. & D1

3221 3/8"

- Extension bar
- DIN 3123



KT NO.	Overall length		⚖️	📦/📦
	inch	mm		
3221-16	1-3/4	44	47	12 / 360
3221-03	3	75	77	12 / 240
3221-06	6	150	146	6 / 120
3221-10	10	250	238	6 / 96
3221-18	18	450	324	1 / 50
3221-24	24	600	424	1 / 50

3223 3/8"

- Offset extension bar
- Max. torque : 150 N·m
- DIN 3123



The offset extension bar has less strength than normal extension bar. Do not use as a normal extension bar.



KT NO.	Overall length		⚖️	📦/📦
	inch	mm		
3223-14	1-1/2	38	40	14 / 224
3223-02	2	50	52	12 / 360
3223-03	3	75	75	12 / 240
3223-06	6	150	144	6 / 120
3223-10	10	250	237	6 / 96

3293 3/8"

- Multi-function of extension bar and offset extension bar
- Max. torque : 150 N·m



KT NO.	Overall length		⚖️	📦/📦
	inch	mm		
3293-03	3	75	75	12 / 240
3293-06	6	150	143	6 / 120
3293-10	10	250	228	6 / 96

3311 3/8"

- Flexible extension bar
- DIN 3120



KT NO.	Overall length		⚖️	📦/📦
	inch	mm		
3311-06	6	150	144	5 / 100
3311-12	12	300	168	12 / 108

3893EW 1/4" & 3/8"

- Extension wrench
- Length extension drive bar enables easier works in confined spaces
- Provided with two square drive adapters in 1/4" and 3/8"
- Chain-driven mechanism enhances working durability and smoothness
- Max torque allowed: 130 N m / 96 ft lb



KT NO.	Drive	Overall length		Capacity	⚖️	📦/📦
		inch	mm			
3893EW		13.4	340	300	410	20 / 40
3893EW-01	3/8"	-	-		20	10 / 160
3893EW-02	1/4"	-	-		20	10 / 160

3452 3/8"

- Flexible handle
- Action degree -180°
- DIN 3122



KT NO.	Overall length		⚖️	📦/📦
	inch	mm		
3452DK	renewal kits		-	-
3452-08F	8	205	291	4 / 80
3452-10F	10	250	310	4 / 64

3453 3/8"

- Flexible handle
- Action degree -180°
- New pattern design added in firm and powerful elements
- New forge technologies I-Beam shank offers 15% lightweight
- DIN 3122



KT NO.	Overall length		⚖️	📦/📦
	inch	mm		
3453DK	renewal kits		-	-
3453-08F	8	200	221	4 / 80

3571 3/8"

- Sliding T-handle
- DIN 3122



KT NO.	Overall length		⚖️	📦/📦
	inch	mm		
3571-08	8	200	178	4 / 80

Accessory

KT No. & DT

3792 3/8"

- Universal joint
- DIN 3123



KT NO.	Overall length		Scales	Boxes
	inch	mm		
3792	2	50	67	15 / 300

3794 3/8"

- Universal joint
- 30° rotation
- Short pattern design enables greater access in confined spaces

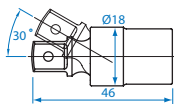

KT NO.	Overall length		Scales	Boxes
	inch	mm		
3794	1-4/5	46	106	15 / 300

9113PR 1/4" 3/8" 1/2"

- Universal joint
- Ball point type universal joint & with hex locking design
- Short pattern design enables greater access in confined spaces



3 PC.

Contents Scales 0.20 Boxes 6 / 108

2793	31mm
3793	43mm
4793	59mm

3812 3814 3/8"

- Adapter
- Convert to 1/4" drive or 1/2" drive
- 3812 → Max. torque : 62 N·m
- DIN 3123, ISO 3316

1/4" drive (M) 3/8" drive (F)
1/2" drive (M)

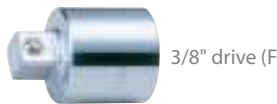

3812 / 3814

KT NO.	Spec.	Scales	Boxes
3812	3/8"Fx1/4"M	30	12 / 192
3814	3/8"Fx1/2"M	46	12 / 360

3148 3/8"

- Bit holder
- DIN 3120 / 3126



KT NO.	Size	Overall length mm	Scales	Boxes
314808S	1/4"	30	35	12 / 360
314810S	5/16"	30	35	12 / 360
314810M	10 mm	30	35	12 / 360

Socket Rail Set

3013MR 3013SR

3513MR 3/8"

- Socket rail 290mmL

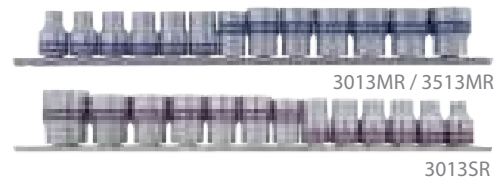

13 PC.

KT NO.	Contents	Scales	Boxes
3013MR	3330M 7, 8, 9, 10, 11, 12, 13, 14, 15, 16, 17, 18, 19	0.52	4 / 24
3013SR	3330S 1/4, 5/16, 11/32, 3/8, 7/16, 15/32, 1/2, 9/16, 19/32, 5/8, 11/16, 3/4, 13/16		8731213
3513MR	3335M 7, 8, 9, 10, 11, 12, 13, 14, 15, 16, 17, 18, 19		

3508MR10 3/8"

- Socket rail 210mmL



8 PC.

Contents	Scales	Boxes
3235M 10, 11, 12, 13, 14, 16, 17, 19	0.65	2 / 24
8730808		

3106PR 3/8"

- Socket rail 150mmL



6 PC.

Contents	Scales	Boxes
3375M E8, E10, E12, E14, E16, E18	0.28	4 / 48
8730606		

3116PR 3/8"

- Socket rail 150mmL



6 PC.

Contents	Scales	Boxes
3275M E4, E5, E8, E10, E12, E14	0.39	4 / 32
8730606		

3129PR 3/8"

- Socket rail 210mmL



9 PC.

Contents	Scales	Boxes
3375M E4, E5, E6, E7, E8, E10, E12, E14, E16	0.27	4 / 32
8730809		

Socket Rail Set

Packing

3109PR8 / 3119PR8 / 3149PR8 / 3131PR8



3121PR

3/8"

- Socket rail 290mmL

11 PC.



Contents

0.32 4 / 24



3375M

E4, E5, E6, E7, E8, E10, E11, E12, E14, E16, E18

8731213

3E07PR

3/8"

- Socket rail 210mmL

7 PC.



Contents

0.42 4 / 32



333E

EP10, EP11, EP12, EP14, EP16, EP18, EP20

8730808

3108PR8

3/8"

- Socket rail 210mmL
- For hex head screw
- H : 50mm

8 PC.



Contents

0.34 50



3025

H3, H4, H5, H6, H7, H8 H10, H12

8730808

3109PR8

3/8"

- Socket rail 210mmL
- For torx head screw
- H : 50mm

9 PC.



Contents

0.36 50



3023

T10, T15, T20, T25, T27, T30, T40, T45, T50

8730809

3119PR8

3/8"

- Socket rail 210mmL
- For tamper resistant torx head screw
- H : 50mm

9 PC.



Contents

0.36 50



3027

T10H, T15H, T20H, T25H, T27H, T30H, T40H, T45H, T50H

8730809

3131PR8

3/8"

- Socket rail 210mmL
- For tamper resistant torx head screw
- H : 50mm

11 PC.



Contents

0.4 48



3027

T8H, T9H, T10H, T15H, T20H, T25H, T27H, T30H, T40H, T45H, T50H

8730811

3146PR

3/8"

- Socket rail 150mmL
- For torx plus tamper resistant head screw
- H : 50mm

6 PC.



Contents

0.36 4 / 32



302D

IPR10, IPR15, IPR20, IPR25, IPR27, IPR30

8730606

3149PR8

3/8"

- Socket rail 210mmL
- For torx plus tamper resistant head screw
- H : 50mm

9 PC.



Contents

0.36 50



302D

IPR10, IPR15, IPR20, IPR25, IPR27, IPR30, IPR40, IPR45, IPR50

8730809

3105PR

3/8"

- 3/8" + 1/2" drive ribe bit socket set
- Socket rail 150mmL
- For ribe head screw
- H : 100mm

5 PC.



Contents

0.75 4 / 32



3039

M7, M8



4049

M10, M12, M13

8740606



Socket Rail

873

3/8"

- Rail length from 160 mm to 560 mm



KT NO.		L (mm)
870406		160
870311		280
870422		560
8730		-

8730811D1

3/8"

- Socket rail carrier with retaining clip
- 446mm roller cabinet



KT NO.	Square drive	Clip	L (mm)
8730811D1	3/8"	11	508

Extension Bar Set

3113PR

3/8"



3 PC.

Contents

0.5 35

3221 3", 6", 10"

3103PR

3/8"



3 PC.

Contents

0.4 35

3223 3", 6", 10"

Socket Set

3213MR

3/8"

Contents

0.79 1 / 24

3330M 8, 9, 10, 11, 12, 13, 14, 15, 16, 17, 19

3755-08G 3221-06

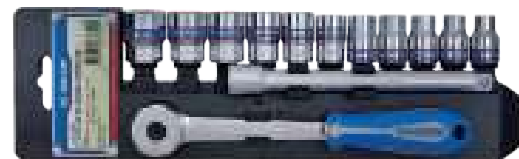

13 PC.

3508MR

3/8"

Metal case size (mm):
203 x 79 x 41 (0.023 cuft)



Contents

1.0 1 / 20

3235M 10, 11, 12, 13, 14, 16, 17, 19

3508SR

3/8"

Metal case size (mm):
203 x 79 x 41 (0.023 cuft)



8 PC.

Contents

1.0 1 / 20

3235S 3/8, 7/16, 1/2, 9/16, 5/8, 11/16, 3/4, 13/16

Socket Set

3020MR

3020SR

3020MR02

3020SR02

3520MR

3520MR02

3/8"

Metal case size (mm) :
372 x 153 x 40 (0.08 cuft)

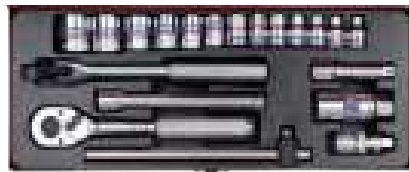



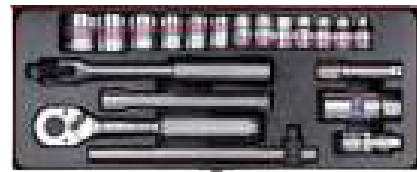







3020MR / 3520MR



3020SR

20
PC.







KT NO.	Contents		Kg	Box	Case
3020MR	 3330M 6, 7, 8, 9, 10, 11, 12, 13, 14, 17, 19, 21, 22	 363021	3769-08F	 	2.5
3020MR02			3779-08F		
3020SR	 3330S 1/4, 5/16, 11/32, 3/8, 7/16, 15/32, 1/2, 9/16, 19/32, 11/16, 3/4, 13/16, 7/8	 363521	3769-08F	 3452-08F	2.5
3020SR02			3779-08F	 3571-08	2.8
3520MR	 3335M 6, 7, 8, 9, 10, 11, 12, 13, 14, 17, 19, 21, 23	 363521	3769-08F	 3792	2.5
3520MR02			3779-08F		2.8

3023MR

3523MR

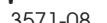
3/8"

Metal case size (mm) :
372 x 153 x 40 (0.08 cuft)

KT NO.	Contents		Kg	Box	Case
3023MR	 3330M 6, 7, 8, 9, 10, 11, 12, 13, 14, 15, 16, 17, 19, 20, 21, 22	 3769-08F	 3452-08F	2.8	1 / 6
3523MR			 3571-08		
			 3221-03  3221-06		
			 3792		



22
PC.









3024MR

3024SR

3524MR

3/8"

Metal case size (mm) :
318 x 147 x 46 (0.076 cuft)

KT NO.	Contents		Kg	Box	Case
3024MR	 3330M 6, 7, 8, 9, 10, 11, 13, 14, 17, 19	 3021 PH2, PH3  3022 5.8  3025 H3, H4, H5, H6, H7, H8, H10	 3779-08G  3792	2.2	1 / 10
3524MR					
3024SR	 3330S 1/4, 5/16, 11/32, 3/8, 7/16, 1/2, 9/16, 5/8, 11/16, 3/4		 3221-06		



3024MR/3524MR

24
PC.



3024SR

Socket Set

3027MR

3027SR

3527MR

3/8"

Metal case size (mm) :
318 x 147 x 46 (0.076 cuft)

KT NO. Contents 2.6 1 / 10

KT NO.	Contents			
3027MR	3330M	7, 8, 9, 10, 11, 12, 13, 14, 15, 16, 17, 18, 19	3235M	3779-08G
3527MR	3335M		8, 10, 11, 12, 13, 14, 16, 17, 19	3221-03
3027SR	3330S	1/4, 5/16, 11/32, 3/8, 7/16, 15/32, 1/2, 9/16, 19/32, 5/8, 11/16, 3/4, 13/16		3812
	3235S		5/16, 3/8, 7/16, 1/2, 9/16, 5/8, 11/16, 3/4, 13/16	3792



3027MR/3527MR



3027SR

26
PC.

3034MR

3534MR

3/8"

Metal case size (mm) :
372 x 153 x 40 (0.08 cuft)

KT NO. Contents 3.1 1 / 6

KT NO.	Contents				
3034MR	3330M	6, 7, 8, 9, 10, 11, 13, 14, 17, 19	3375M	E4, E5, E6, E7, E8, E10, E12, E14, E16, E18	
3534MR	3335M		3023	T8, T9, T10, T15, T20, T25, T27, T30, T40, T45	3779-08G
			3571-08	3221-03	3221-06
			3792		

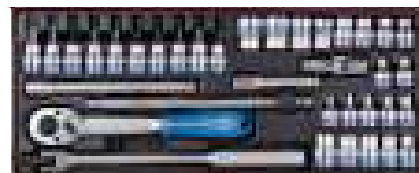

36
PC.

3036CR

3/8"

Metal case size (mm) :
372 x 153 x 40 (0.08 cuft)

Contents 3.27 1 / 6

3330M	6, 7, 8, 9, 10, 11, 12, 13, 14, 15, 16, 17, 19, 20, 21, 22
3330S	1/4, 5/16, 11/32, 3/8, 7/16, 15/32, 1/2, 9/16, 19/32, 5/8, 11/16, 3/4, 13/16, 7/8
3769-08F	3452-08F
3571-08	3221-03
	3221-06
	3792

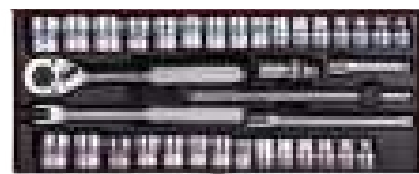

36
PC.

3537MR

3/8"

Metal case size (mm) :
372 x 153 x 40 (0.08 cuft)

Contents 3.17 1 / 6

3023	T8, T9, T10, T15, T20, T25, T27, T30, T40, T45
3335M	6, 7, 8, 9, 10, 11, 12, 13, 14, 15, 17, 18, 19
3375M	E4, E5, E6, E7, E8, E10, E12, E14, E16, E18
3779-08G	3452-10F
	3571-08
	3221-03
	3221-06
	3792

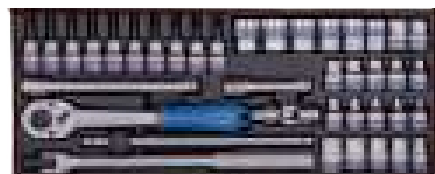

39
PC.

Socket Set

3055CR

3/8"

Metal case size (mm) :
490 x 205 x 52 (0.185 cuft)

Contents		⚖️ 6	📦 1 / 3
○	3330M	6, 7, 8, 9, 10, 11, 12, 13, 14, 15, 16, 17, 18, 19, 20, 21, 22	
○	3230M	10, 11, 12, 13, 14, 15, 16, 17, 18, 19	
○	3330S	1/4, 5/16, 3/8, 7/16, 1/2, 9/16, 5/8, 11/16, 3/4, 13/16, 7/8	
○	3230S	1/4, 5/16, 3/8, 7/16, 1/2, 9/16, 5/8, 11/16, 3/4	
○	363516	○	363521
🔧	3771-08G	🔧	3452-10F
🔧	3293-06	🔧	3221-03 3221-10

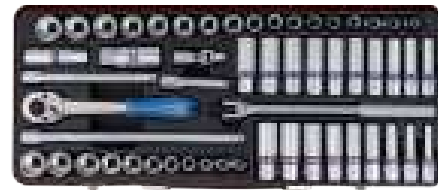

55 PC.

3523MRV10

Tray category #10 (375 x 140mm) 3/8"

Plastic case size (mm) :
389 x 185 x 66 (0.168 Cuft)

Contents		⚖️ 2.43	📦 1 / 10
○	3335M	6, 7, 8, 9, 10, 11, 12, 13, 14, 15, 16, 17, 19, 21, 22, 23, 24	
🔧	3771-08G	🔧	3792
🔧	3571-08	🔧	3452-08F
🔧	3293-03 3293-06		



23 PC.

3023MRV11

3523MRV11

Tray category #10 (375 x 140mm) 3/8"

Plastic case size (mm) :
389 x 185 x 66 (0.168 Cuft)



3023MRV11



3523MRV11

23 PC.

KT NO.	Contents	⚖️ 2.40	📦 1 / 10
3023MRV11	○ 3330M	6, 7, 8, 9, 10, 11, 12, 13, 14, 15, 16, 17, 18, 19, 21, 22, 24	🔧 3771-08G 🔧 3453-08F
3523MRV11	○ 3335M	6, 7, 8, 9, 10, 11, 12, 13, 14, 15, 16, 17, 18, 19, 21, 22, 24	🔧 3571-08 🔧 3293-03 🔧 3293-06 🔧 3792

3032SRV

Tray category #8 (375 x 187mm) 3/8"

Plastic case size (mm) :
389 x 230 x 66 (0.168 Cuft)

Contents		⚖️ 3.28	📦 1 / 6
○	3230S	5/16, 3/8, 7/16, 15/32, 1/2, 9/16, 19/32, 5/8, 11/16, 3/4, 13/16, 7/8	
○	3330S	1/4, 5/16, 11/32, 3/8, 7/16, 15/32, 1/2, 9/16, 19/32, 5/8, 11/16, 3/4, 13/16, 7/8, 15/16	
🔧	3771-08G	🔧	3453-08F
🔧	3293-03 3293-06	🔧	3792

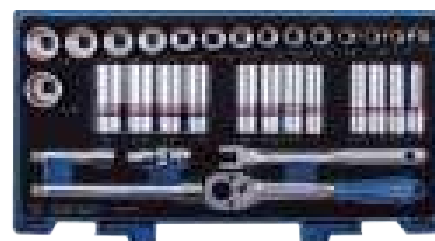

32 PC.

Socket Set

3033MRV

Plastic case size (mm) :
389 x 230 x 66 (0.168 Cuft)



3033MRV

3533MRV

Tray category #8 (375 x 187mm) 3/8"



3533MRV

33
PC.

KT NO.	Contents	kg 3.40	1 / 6
3033MRV	3330M 7, 8, 9, 10, 11, 12, 13, 14, 15, 16, 17, 18, 19, 21, 22, 24	3771-08G	3792
	3230M 8, 10, 11, 12, 13, 14, 15, 16, 17, 19, 21, 22		
3533MRV	3335M 7, 8, 9, 10, 11, 12, 13, 14, 15, 16, 17, 18, 19, 21, 22, 24	3453-08F	3293-03 3293-06
	3235M 8, 10, 11, 12, 13, 14, 15, 16, 17, 19, 21, 22		

3545MRV

Plastic case size (mm) :
389 x 230 x 66 (0.168 Cuft)

Contents 2.47 1 / 6

3335M	6, 7, 8, 9, 10, 11, 12, 13, 14, 15, 16, 17, 18, 19, 21, 22, 24
3375M	E4, E5, E6, E7, E8, E10, E11, E12, E14, E16, E18
3023	T8, T9, T10, T15, T20, T25, T27, T30, T40, T45, T50
3771-08G	3453-08F
3571-08	3792 3293-03 3293-06



45
PC.

3054MR

Blow case size (mm) :
340 x 263 x 80 (0.25cuft)

Contents 3.85 1 / 3

3330M	6, 7, 8, 9, 10, 11, 12, 13, 14, 15, 17, 18, 19, 21, 22
3235M	8, 10, 12, 13, 14
1025T	T10, T15, T20, T25, T30, T40, T45 T50
3630	16, 21
1145MR	H1.5, H2, H2.5, H3, H4, H5, H6, H8, H10
14A1	PH2 x 100
14A2	5.5 x 100
1060	8, 10, 12, 13, 14, 17, 19
3771-08G	3792 3221-03 3221-06
31480S	6111-06



54
PC.

Socket Set

3568MR



3/8"

Metal shelf size (mm) :
415 x 336 x 320 (1.58 cuft)

268
PC.



HAND SOCKET & ACCESSORIES

Contents		Each Q'ty	
○ 	3335M	8, 9, 10, 11, 12, 13	10
		14, 15, 16, 17, 18, 19	8
		21, 22, 23, 24	6
○ 	3235M	7, 8, 9, 10, 11, 12, 13	10
		14, 15, 16, 17, 18, 19	8
		21, 22, 24	6



KT NO.	Spec.		Cuft
3568MR-A	87102	6.35	0.67
3568MR-D	268 PC. socket content	16.50	0.38



Standard Socket

KT No. & D1 

4330MR

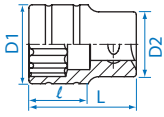

4330SR 1/2"



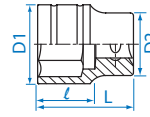

4335MR







4335SR 1/2"



KT NO.	mm	D1 mm	D2 mm	l mm	L mm		
433008MR	8	13.2	23.3	7.0	38	53	10 / 200
433009MR	9	14.0	23.3	7.0	38	52	10 / 200
433010MR	10	15.0	23.3	8.0	38	51	10 / 200
433011MR	11	16.4	23.3	8.0	38	54	10 / 200
433012MR	12	17.8	23.3	9.0	38	54	10 / 200
433013MR	13	19.0	23.3	10.0	38	58	10 / 200
433014MR	14	20.4	23.3	11.0	38	60	10 / 200
433015MR	15	21.6	23.3	11.0	38	61	10 / 200
433016MR	16	22.5	23.3	11.0	38	61	10 / 200
433017MR	17	24.0	23.2	12.0	38	62	10 / 200
433018MR	18	25.2	23.2	13.0	38	69	10 / 200
433019MR	19	27.0	23.2	13.0	38	72	10 / 160
433020MR	20	27.9	23.2	13.0	38	74	10 / 160
433021MR	21	28.9	23.2	14.0	38	78	10 / 160
433022MR	22	30.2	24.0	15.0	40	90	10 / 160
433023MR	23	31.2	25.0	15.0	40	92	8 / 160
433024MR	24	32.1	26.0	17.0	42	101	8 / 160
433025MR	25	33.4	27.0	17.0	42	107	8 / 160
433026MR	26	35.0	28.0	17.0	42	125	6 / 120
433027MR	27	36.6	28.0	19.0	42	130	6 / 120
433028MR	28	37.8	30.0	20.0	42	142	6 / 120
433029MR	29	39.0	30.0	21.0	44	161	6 / 120
433030MR	30	40.0	29.5	21.0	44	156	6 / 120
433032MR	32	42.5	30.0	23.0	44	163	6 / 120
433033MR	33	43.0	30.0	24.0	46	173	6 / 96
433034MR	34	45.0	30.0	24.0	46	207	6 / 96
433036MR	36	47.0	33.0	24.0	46	236	6 / 96

KT NO.	inch	D1 mm	D2 mm	l mm	L mm		
433010SR	5/16	13.2	21.8	7.0	38	41	10 / 200
433012SR	3/8	15.0	21.8	7.0	38	44	10 / 200
433013SR	13/32	15.0	23.3	7.0	38	51	10 / 200
433014SR	7/16	16.4	23.3	8.0	38	53	10 / 200
433015SR	15/32	18.0	23.3	8.0	38	55	10 / 200
433016SR	1/2	19.0	23.3	10.0	38	57	10 / 200
433018SR	9/16	20.4	23.3	11.0	38	59	10 / 200
433019SR	19/32	21.6	23.3	11.0	38	60	10 / 200
433020SR	5/8	22.5	23.3	11.0	38	62	10 / 200
433022SR	11/16	24.0	23.2	12.0	38	60	10 / 200
433024SR	3/4	27.0	23.2	13.0	38	73	10 / 160
433025SR	25/32	28.0	23.2	13.0	38	75	10 / 160
433026SR	13/16	28.6	23.2	13.0	38	79	10 / 160
433028SR	7/8	30.2	24.0	15.0	40	87	10 / 160
433030SR	15/16	32.6	26.0	17.0	42	105	8 / 160
433032SR	1	34.8	26.8	17.0	42	119	8 / 160
433034SR	1-1/16	36.6	28.0	19.0	42	133	6 / 120
433036SR	1-1/8	39.0	30.0	21.0	44	158	6 / 120
433038SR	1-3/16	40.0	29.5	21.0	44	156	6 / 120
433040SR	1-1/4	42.5	30.0	23.0	44	173	6 / 120
433044SR	1-3/8	46.0	33.0	24.0	46	243	6 / 96

KT NO.	mm	D1 mm	D2 mm	l mm	L mm		
433506MR	6	12.0	23.3	7.0	38	51	10 / 200
433507MR	7	12.6	23.3	7.0	38	51	10 / 200
433508MR	8	13.2	23.3	7.0	38	52	10 / 200
433509MR	9	14.0	23.3	7.0	38	51	10 / 200
433510MR	10	15.0	23.3	8.0	38	51	10 / 200
433511MR	11	16.4	23.3	8.0	38	54	10 / 200
433512MR	12	17.8	23.3	9.0	38	56	10 / 200
433513MR	13	19.0	23.3	10.0	38	58	10 / 200
433514MR	14	20.4	23.3	11.0	38	61	10 / 200
433515MR	15	21.6	23.3	11.0	38	62	10 / 200
433516MR	16	22.5	23.3	11.0	38	63	10 / 200
433517MR	17	24.0	23.2	13.5	38	63	10 / 200
433518MR	18	25.2	23.2	13.5	38	66	10 / 200
433519MR	19	27.0	23.2	17.0	38	74	10 / 160
433520MR	20	27.9	23.2	17.0	38	76	10 / 160
433521MR	21	28.9	23.2	17.0	38	79	10 / 160
433522MR	22	30.2	24.0	17.0	38	90	10 / 160
433523MR	23	31.2	25.0	17.0	38	99	8 / 160
433524MR	24	32.1	26.0	17.0	38	108	8 / 160
433525MR	25	33.4	27.0	18.0	40	118	8 / 160
433526MR	26	35.0	28.0	21.0	42	130	6 / 120
433527MR	27	36.6	28.0	21.0	42	141	6 / 120
433528MR	28	37.8	30.0	20.0	42	154	6 / 120
433529MR	29	39.0	30.0	20.0	44	165	6 / 120
433530MR	30	40.0	29.5	22.0	44	164	6 / 120
433532MR	32	42.5	30.0	22.0	44	180	6 / 120
433533MR	33	43.0	30.0	24.0	46	185	6 / 96
433534MR	34	45.0	30.0	24.0	46	206	6 / 96
433536MR	36	47.0	33.0	24.0	46	251	6 / 96
433538MR	38	49.0	34.0	25.0	50	268	6 / 60
433539MR	39	50.0	34.0	25.0	50	291	6 / 60
433541MR	41	53.0	36.0	27.0	53	336	6 / 36
433546MR	46	59.0	40.0	30.0	58	453	4 / 32

KT NO.	inch	D1 mm	D2 mm	l mm	L mm		
433510SR	5/16	13.2	21.8	7.0	38	44	10 / 200
433512SR	3/8	15.0	21.8	7.0	38	45	10 / 200
433514SR	7/16	16.4	23.3	8.0	38	54	10 / 200
433515SR	15/32	18.0	23.3	8.0	38	56	10 / 200
433516SR	1/2	19.0	23.3	10.0	38	58	10 / 200
433518SR	9/16	20.4	23.3	11.0	38	59	10 / 200
433519SR	19/32	21.6	23.3	11.0	38	61	10 / 200
433520SR	5/8	22.5	23.3	11.0	38	62	10 / 200
433522SR	11/16	24.0	23.2	12.0	38	62	10 / 200
433524SR	3/4	27.0	23.2	13.0	38	75	10 / 160
433525SR	25/32	28.0	23.2	13.0	38	77	10 / 160
433526SR	13/16	28.6	23.2	13.0	38	80	10 / 160
433528SR	7/8	30.2	24.0	15.0	40	92	10 / 160
433530SR	15/16	32.6	26.0	17.0	42	113	8 / 160
433532SR	1	34.8	26.8	17.0	42	124	8 / 160
433534SR	1-1/16	36.6	28.0	19.0	42	138	6 / 120
433536SR	1-1/8	39.0	30.0	21.0	44	166	6 / 120
433538SR	1-3/16	40.0	29.5	21.0	44	168	6 / 120
433540SR	1-1/4	42.5	30.0	23.0	44	176	6 / 120

Socket Set

4072MR

4072SR

4572MR









4572SR

1/2"

Metal shelf size (mm) :
415x 336 x 320 (1.58 cuft)



4072MR / 4572MR

KT NO.	PC.		Contents	Each Q'ty	
4072MR	172		 4330MR	8, 9, 10, 11, 12, 13, 14, 15, 16, 17, 18	8
				19, 20, 21, 22, 23, 24, 25	7
4572MR	172		 4335MR	26, 27, 28, 29, 30,	6
				32	5
4072SR	136		 4330SR	5/16, 3/8, 7/16, 15/32, 1/2, 9/16, 19/32, 5/8, 11/16	8
				3/4, 25/32, 13/16, 7/8, 15/16	7
4572SR	136		 4335SR	1, 1-1/16, 1-1/8, 1-3/16	6
				1-1/4	5

KT NO.	Spec.		Cuft
4072MR -A 4572MR	87103	6.37	0.67
4072MR -D 4572MR	172 PC. socket content	17.73	0.38
4072SR -A 4572SR	87103	6.37	0.67
4072SR -D 4572SR	136 PC. socket content	13.00	0.28



Deep Socket



4230M

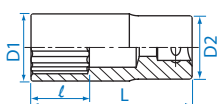

4230S  1/2"

- Metric-DIN 3124, ISO 2725-1
- Inch-ANSI / ASME B107.1



KT NO.	 mm	D1 mm	D2 mm	l mm	L mm		
423008M	8	13.2	22.0	16	77	79	6 / 120
423009M	9	14.0	22.0	16	77	79	6 / 120
423010M	10	15.2	23.7	24	77	99	6 / 120
423011M	11	16.3	23.7	24	77	104	6 / 120
423012M	12	17.7	23.7	24	77	110	6 / 120
423013M	13	18.7	23.7	24	77	114	6 / 120
423014M	14	20.2	23.7	35	77	121	6 / 120
423015M	15	21.3	23.7	35	77	120	6 / 120
423016M	16	22.6	23.7	35	77	128	6 / 96
423017M	17	23.7	23.2	35	77	122	6 / 96
423018M	18	25.5	23.2	35	77	141	6 / 96
423019M	19	25.7	23.2	35	77	126	6 / 96
423020M	20	27.7	24.0	35	77	150	6 / 96
423021M	21	27.7	25.0	35	77	148	6 / 96
423022M	22	29.8	26.0	35	77	175	6 / 96

KT NO.	 mm	D1 mm	D2 mm	l mm	L mm		
423023M	23	31.8	27.5	35	77	210	5 / 60
423024M	24	31.8	28.5	35	77	204	5 / 60
423025M	25	33.8	29.5	35	77	239	5 / 60
423026M	26	35.8	30.5	35	77	220	5 / 60
423027M	27	35.8	31.5	34	77	253	5 / 60
423028M	28	37.8	32.5	34	77	308	5 / 50
423029M	29	37.8	33.5	34	77	273	5 / 50
423030M	30	39.8	34.5	34	77	276	5 / 50
423032M	32	41.8	36.0	34	77	309	5 / 50
423033M	33	43.8	38.5	35	77	356	5 / 50
423034M	34	44.8	38.5	35	77	422	5 / 50
423036M	36	46.8	40.5	36	77	462	2 / 40

KT NO.	 inch	D1 mm	D2 mm	l mm	L mm		
423010S	5/16	13.2	22.0	9	77	92	6 / 120
423012S	3/8	14.7	22.0	10	77	82	6 / 120
423014S	7/16	16.3	23.7	12	77	98	6 / 120
423016S	1/2	18.7	23.7	14	77	114	6 / 120
423018S	9/16	20.2	23.7	15	77	119	6 / 120
423020S	5/8	22.6	23.7	17	77	129	6 / 96
423022S	11/16	23.7	23.2	35	77	124	6 / 96
423024S	3/4	25.7	23.2	35	77	128	6 / 96
423026S	13/16	27.7	25.0	37	77	151	6 / 96
423028S	7/8	29.8	26.0	37	77	170	6 / 96
423030S	15/16	31.8	28.5	37	77	208	5 / 60
423032S	1	33.8	29.5	37	77	233	5 / 60
423034S	1-1/16	36.6	31.5	28	77	247	5 / 60
423036S	1-1/8	37.8	32.5	28	77	254	5 / 50
423038S	1-3/16	39.8	34.5	34	77	285	5 / 50
423040S	1-1/4	41.8	36.0	34	77	305	5 / 50

Deep Socket

KT No. & D1

4235M

4235S \bigcirc 1/2"

- Metric-DIN 3124, ISO 2725-1
- ANSI / ASME B107.1

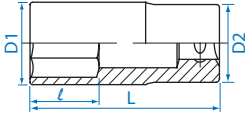

KT NO.	\bigcirc mm	D1 mm	D2 mm	l mm	L mm		
423508M	8	13.2	22.0	16	77	90	6 / 120
423509M	9	14.0	22.0	16	77	81	6 / 120
423510M	10	15.2	23.7	24	77	102	6 / 120
423511M	11	16.3	23.7	24	77	103	6 / 120
423512M	12	17.7	23.7	24	77	113	6 / 120
423513M	13	18.7	23.7	24	77	119	6 / 120
423514M	14	20.2	23.7	35	77	121	6 / 120
423515M	15	21.3	23.7	35	77	126	6 / 120
423516M	16	22.6	23.7	35	77	130	6 / 96
423517M	17	23.7	23.2	35	77	127	6 / 96
423518M	18	25.5	23.2	35	77	149	6 / 96
423519M	19	25.7	23.2	35	77	133	6 / 96
423520M	20	27.7	24.0	35	77	158	6 / 96
423521M	21	27.7	25.0	35	77	155	6 / 96
423522M	22	29.8	26.0	35	77	185	6 / 96
423523M	23	31.8	27.5	35	77	218	5 / 60
423524M	24	31.8	28.5	35	77	211	5 / 60
423525M	25	33.8	29.5	35	77	251	5 / 60
423526M	26	35.8	30.5	35	77	236	5 / 60
423527M	27	35.8	31.5	34	77	295	5 / 60
423528M	28	37.8	32.5	34	77	281	5 / 50
423529M	29	37.8	33.5	34	77	292	5 / 50
423530M	30	39.8	34.5	34	77	301	5 / 50
423532M	32	41.8	36.0	34	77	330	5 / 50
423533M	33	43.8	38.5	35	77	373	5 / 50
423534M	34	44.8	38.5	35	77	478	5 / 50
423536M	36	46.8	40.5	36	77	478	2 / 40
423538M	38	49.0	40.5	38	77	504	2 / 40
423541M	41	53.0	40.5	40	77	521	2 / 24

KT NO.	\bigcirc inch	D1 mm	D2 mm	l mm	L mm		
423510S	5/16	13.2	22.0	16	77	90	6 / 120
423512S	3/8	14.7	22.0	16	77	84	6 / 120
423514S	7/16	16.3	23.7	24	77	104	6 / 120
423516S	1/2	18.7	23.7	24	77	116	6 / 120
423518S	9/16	20.2	23.7	35	77	123	6 / 120
423520S	5/8	22.6	23.7	35	77	130	6 / 96
423522S	11/16	23.7	23.2	35	77	124	6 / 96
423524S	3/4	25.7	23.2	35	77	131	6 / 96
423526S	13/16	27.7	25.0	35	77	157	6 / 96
423528S	7/8	29.8	26.0	35	77	181	6 / 96
423530S	15/16	31.8	28.5	35	77	218	5 / 60
423532S	1	33.8	29.5	35	77	223	5 / 60
423534S	1-1/16	36.6	31.5	34	77	266	5 / 60
423536S	1-1/8	37.8	32.5	34	77	262	5 / 50
423538S	1-3/16	39.8	34.5	34	77	296	5 / 50
423540S	1-1/4	41.8	36.0	34	77	327	5 / 50
423542S	1-5/16	44.0	38.5	35	77	430	5 / 50
423544S	1-3/8	46.0	38.5	35	77	452	2 / 40
423546S	1-7/16	47.5	40.5	36	77	485	2 / 40
423548S	1-1/2	49.0	40.5	38	77	507	2 / 40

4245M

EXTENDED LENGTH \bigcirc 1/2"

- DIN 3120

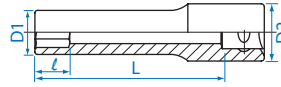

KT NO.	\bigcirc mm	D1 mm	D2 mm	l mm	L mm		
424508M	8	13.2	22.0	9.0	90	104	6 / 120
424509M	9	14.0	22.0	10.0	90	106	6 / 120
424510M	10	15.2	23.7	11.0	90	130	6 / 120
424512M	12	17.7	23.7	13.0	90	152	6 / 120
424513M	13	18.7	23.7	14.0	90	151	6 / 120
424514M	14	20.2	23.7	15.0	90	159	6 / 120

4255M

EXTENDED LENGTH \bigcirc 1/2"

- DIN 3120

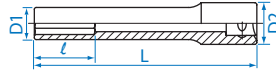

KT NO.	\bigcirc mm	D1 mm	D2 mm	l mm	L mm		
425508M	8	13.2	22.0	9	120	127	6 / 96
425509M	9	14.0	22.0	10	120	134	6 / 96
425510M	10	15.2	23.7	11	120	160	6 / 96
425512M	12	17.7	23.7	13	120	195	6 / 96
425513M	13	18.7	23.7	14	120	201	6 / 96
425514M	14	20.2	23.7	15	120	202	6 / 96

Square Socket

4014M

\blacksquare 1/2"

- DIN 3120

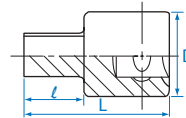

KT NO.	\blacksquare mm	inch	D mm	l mm	L mm		
401408M	RB8.0		23.5	13.5	35	54	10 / 200
401409M	RB9.5	3/8	23.5	13.5	35	58	10 / 200
401410M	RB10.0		23.5	13.5	35	57	10 / 200
401411M	RB10.5		23.5	13.5	35	58	10 / 200
401412M	RB12.0		23.5	13.5	35	62	10 / 200
401413M	RB12.7	1/2	23.5	13.5	35	64	10 / 200
401414M	RB13.5		23.5	13.5	35	67	10 / 200
401419M	RB19.0		25.0	15.5	40	108	10 / 160

Deep Socket Set

4066MR

4066SR

4566MR

1/2"

Metal shelf size (mm) :
415x 336 x 320 (1.58 cuff)



4066MR / 4566MR

KT NO.	PC.	Contents		Each Q'ty	KT NO.	Spec.		Cuff
4066MR	165		4230M	8, 9, 10, 11, 12, 13, 14, 15, 16, 17, 18 19, 20, 21, 22, 23, 24	8 7	4066MR-A 4566MR	87103	5.87 0.62
4566MR	165		4235M	26, 27, 28, 29, 30 32	6 5	4066MR-D 4566MR	165 PC. socket content	30.70 0.63
4066SR	114		4230S	5/16, 3/8, 7/16, 1/2, 9/16, 5/8, 11/16	8	4066SR -A	87103	5.87 0.62
				3/4, 13/16, 7/8, 15/16, 1	7			
				1-1/16, 1-1/8, 1-3/16	6			
				1-1/4	5			
4066SR -D				114 PC. socket content	21.0 0.47			

Star Socket

4375M

1/2"

- For torx external screw
- Chrome vanadium steel
- Polished, chrome plated
- DIN 3120

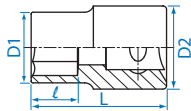

KT NO.	mm	D1 mm	D2 mm	ℓ mm	L mm		
437508M	E08	11.4	23.8	7.0	37	52	10 / 200
437510M	E10	13.2	23.8	7.5	37	55	10 / 200
437511M	E11	14.0	23.8	8.0	37	57	10 / 200
437512M	E12	15.0	23.8	9.0	37	58	10 / 200
437514M	E14	16.4	23.8	10.0	37	59	10 / 200
437516M	E16	18.8	23.8	11.0	37	63	10 / 200
437518M	E18	20.5	23.8	12.5	39	68	10 / 200
437520M	E20	22.8	23.8	14.0	39	72	10 / 200
437522M	E22	24.6	23.8	16.0	39	78	10 / 200
437524M	E24	26.5	23.8	16.0	39	85	10 / 160

4275M

1/2"

- Long type
- Chrome vanadium steel
- Polished, chrome plated
- DIN 3120

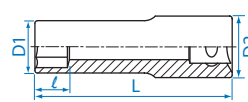

KT NO.	mm	D1 mm	D2 mm	ℓ mm	L mm		
427508M	E08	11.4	23.8	7.0	77	106	6 / 120
427510M	E10	13.2	23.8	7.5	77	112	6 / 120
427512M	E12	15.0	23.8	9.0	77	121	6 / 120
427514M	E14	16.4	23.8	10.0	77	127	6 / 120
427516M	E16	18.8	23.8	11.0	77	143	6 / 120
427518M	E18	20.5	23.8	12.5	77	148	6 / 120
427520M	E20	22.8	23.8	14.0	77	161	6 / 120
427522M	E22	24.6	23.8	16.0	77	178	6 / 96
427524M	E24	26.5	23.8	16.0	77	197	6 / 96

433E

1/2"

- For torx plus external screw
- DIN 3120

KT NO.	mm	D1 mm	D2 mm	ℓ mm	L mm		
433E18M	E18	21	25.8	15.0	45	91	6 / 96
433E20M	E20	23	25.8	15.0	45	98	6 / 96
433E22M	E22	-	25.8	17.0	45	110	6 / 96
433E24M	E24	27.8	26.0	18.0	45	119	6 / 96
433E26M	E26	29.8	26.0	19.0	45	125	6 / 96
433E28M	E28	31.8	26.0	21.0	45	125	6 / 96
433E30M	E30	33.8	26.0	22.0	45	131	6 / 96
433E32M	E32	35.8	26.0	23.0	45	149	6 / 96

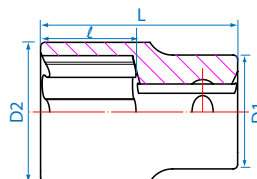

Spark Plug Socket

KT No. & D1



4630RC



4660



4635RC



4665C



4670



4675



- 6 / 12 points
- Size combined
 - 16.0mm (5/8")
 - 20.8mm (13/16")
- Inside sleeve
 - rubber
 - magnet
- DIN 3120
- 14mm use for Toyota Yaris, Vios



Magnet



463014RC - Thin walled design



463514RC - Thin walled design



463016RC - Thin walled design



466016 - Thin walled design



463516RC - Thin walled design



466516C - Thin walled design



463021RC



466021



463521RC



466521C

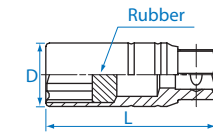

Rubber

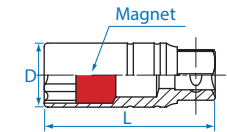

Magnet

KT NO.	Type	Size		D mm	L mm	G	H	I	J
		inch	mm						
463014RC	12 points Rubber	-	14.0	19.05	70	70	12	240	
463016RC	12 points Rubber	5/8	16.0	20.75	70	72	10	200	
466016	12 points Magnet	5/8	16.0	20.75	70	74	10	200	
463514RC	6 points Rubber	-	14.0	19.05	70	70	12	240	
463516RC	6 points Rubber	5/8	16.0	20.75	70	76	10	200	
466516C	6 points Magnet	5/8	16.0	20.75	70	77	10	200	
463021RC	12 points Rubber	13/16	20.8	27.7	70	142	12	120	
466021	12 points Magnet	13/16	20.8	27.7	70	139	12	120	
463521RC	6 points Rubber	13/16	20.8	27.7	70	148	12	120	
466521C	6 points Magnet	13/16	20.8	27.7	70	150	12	120	
467014C	12 points Metal clip	-	14.0	19.05	70	70	12	240	
467016	12 points Metal clip	5/8	16.0	20.75	70	73	10	200	
467021	12 points Metal clip	13/16	20.8	27.7	70	121	12	120	
467514C	6 points Metal clip	-	14.0	19.05	70	70	12	240	
467516	6 points Metal clip	5/8	16.0	20.75	70	74	10	200	
467521	6 points Metal clip	13/16	20.8	27.7	70	162	12	120	



467514C



467014C

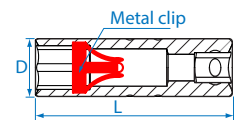

Metal clip



Bit Socket



In order to get normal life of bit socket, always use within limited torque to bit.



4021



- Phillips head
- DIN ISO 8764-1



KT NO.	⊕ No.	Overall length mm		
402102	PH2	60	67	10 / 180
402103	PH3	60	77	10 / 180
402104	PH4	60	68	10 / 180

4025

4035

40D5



- Hexagon head
- DIN 7422

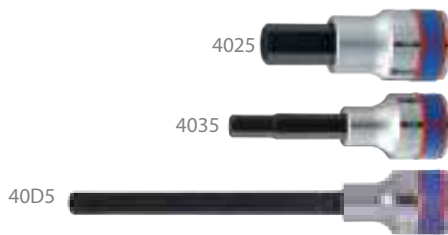

KT NO.	mm / Inch	Overall length mm		
402503	H3	60	65	10 / 180
402504	H4	60	65	10 / 180
402505	H5	60	66	10 / 180
402506	H6	60	68	10 / 180
402507	H7	60	67	10 / 180
402508	H8	60	70	10 / 180
402509	H9	60	78	10 / 180
402510	H10	60	80	10 / 180
402511	H11	60	95	10 / 180
402512	H12	60	94	10 / 180
402514	H14	60	114	10 / 180
402517	H17	66	166	10 / 100
402519	H19	66	225	10 / 120
403504	H4	80	74	6 / 120
403505	H5	80	75	6 / 120
403506	H6	80	77	6 / 120
403507	H7	80	77	6 / 120
403508	H8	80	80	6 / 120
403509	H9	80	91	6 / 120
403510	H10	80	93	6 / 120
403511	H11	80	111	6 / 120
403512	H12	80	113	6 / 120
403514	H14	80	140	6 / 120
403517	H17	80	193	6 / 120
403519	H19	80	259	6 / 96
40D506	H6	140	101	6 / 120
40D508	H8	140	102	6 / 120
40D510	H10	140	131	6 / 120
402506S	3/16	60	66	10 / 180
402507S	7/32	60	68	10 / 180
402508S	1/4	60	69	10 / 180
402509S	9/32	60	71	10 / 180
402510S	5/16	60	76	10 / 180
402512S	3/8	60	79	10 / 180
402514S	7/16	60	92	10 / 180
402516S	1/2	60	110	10 / 180
402518S	9/16	66	156	10 / 120
402520S	5/8	66	162	10 / 120
402524S	3/4	66	226	10 / 120

4022



- Slotted head
- DIN ISO 5264 / 3120



KT NO.	Tip width mm	Tip thickness mm	Overall length mm		
402208	8	1.2	60	68	10 / 180
402210	10	1.6	60	75	10 / 180
402212	12	2.0	60	89	10 / 180
402214	14	2.5	60	104	10 / 180
402216	16	2.5	60	104	10 / 180

40D0



- Hexagon with ball point head



KT NO.	mm	Overall length mm		
40D006	H6	140	101	6 / 120
40D008	H8	140	103	6 / 120
40D010	H10	140	132	6 / 120

4026

4036



4046

4066

- Spline head
- DIN 3120



KT NO.	Size	Overall length mm		
402605	M5	60	69	10 / 180
402606	M6	60	67	10 / 180
402608	M8	60	70	10 / 180
402610	M10	60	78	10 / 180
402612	M12	60	91	10 / 180
402614	M14	60	108	10 / 180
402616	M16	60	144	10 / 120
402618	M18	60	195	10 / 120
403605	M5	80	75	6 / 120
403606	M6	80	76	6 / 120
403608	M8	80	76	6 / 120
403610	M10	80	91	6 / 120
403612	M12	80	110	6 / 120
403614	M14	80	135	6 / 120
404605	M5	100	83	6 / 120
404607	M7	100	84	6 / 120
404608	M8	100	85	6 / 120
404610	M10	100	105	6 / 120
404612	M12	100	128	6 / 120
404614	M14	100	161	6 / 120
406608	M8	140	102	6 / 120
406609	M9	140	131	6 / 120
406610	M10	140	130	6 / 120
406612	M12	140	168	6 / 120
406614	M14	140	212	6 / 120
406616	M16	140	301	6 / 72

Bit Socket

KT No. & D1



404108



- Spline head
- DIN 3120
- Use for Toyota Tercel cylinder head bolt



KT NO.	Size	Overall length mm		
404108	M8.9	100	123	6 / 120

402A



- Pentagon head
- For using on most vehicles fitting brake system



KT NO.	Size	Overall length mm		
402A10	10	60	89	10 / 180

402B



- Spline head
- Tamper resistant type
- For gearbox and pump plugs of Audi A4/A6/A3, Golf IV/LT of VW



KT NO.	Size	Overall length mm		
402B16	M16	66	151	10 / 120
402B18	M18	66	204	10 / 120

4049



- Use for VW, Audi, Fiat cylinder head bolt



KT NO.	Size	Overall length mm		
404904	M4	100	81	6 / 120
404905	M5	100	83	6 / 120
404906	M6	100	83	6 / 120
404907	M7	100	83	6 / 120
404908	M8	100	84	6 / 120
404909	M9	100	102	6 / 120
404910	M10	100	103	6 / 120
404925	M10.5	100	102	6 / 120
404912	M12	100	127	6 / 120
404913	M13	100	156	6 / 120
404914	M14	100	159	6 / 120
404916	M16	100	215	6 / 120

4027

- For tamper resistant torx screw
- DIN 3120



4027



4037

KT NO.	Size	Overall length mm		
402720	T20H	60	65	10 / 180
402725	T25H	60	66	10 / 180
402727	T27H	60	66	10 / 180
402730	T30H	60	66	10 / 180
402740	T40H	60	67	10 / 180
402745	T45H	60	70	10 / 180
402750	T50H	60	68	10 / 180
402755	T55H	60	77	10 / 180
402760	T60H	60	105	10 / 180
403720	T20H	80	74	6 / 120
403725	T25H	80	73	6 / 120
403727	T27H	80	74	6 / 120
403730	T30H	80	77	6 / 120
403740	T40H	80	76	6 / 120
403745	T45H	80	77	6 / 120
403750	T50H	80	79	6 / 120
403755	T55H	80	90	6 / 120
403760	T60H	80	131	6 / 120

4023

- For torx internal screw
- DIN 3120



4023



4033

KT NO.	Size	Overall length mm		
402320	T20	60	68	10 / 180
402325	T25	60	66	10 / 180
402327	T27	60	68	10 / 180
402330	T30	60	65	10 / 180
402340	T40	60	67	10 / 180
402345	T45	60	69	10 / 180
402350	T50	60	69	10 / 180
402355	T55	60	78	10 / 180
402360	T60	60	106	10 / 180
402370	T70	60	110	10 / 180
403320	T20	80	76	6 / 120
403325	T25	80	74	6 / 120
403327	T27	80	75	6 / 120
403330	T30	80	75	6 / 120
403340	T40	80	78	6 / 120
403345	T45	80	76	6 / 120
403350	T50	80	79	6 / 120
403355	T55	80	92	6 / 120
403360	T60	80	132	6 / 120
403370	T70	80	136	6 / 120



Ratchet & Set

KT No. & D1

4725

FINE GEAR 1/2"

- Reversible ratchet
- 8° gear action degree (45 teeth)
- DIN 3122

KT NO.	Overall length			
	inch	mm		
4725-10FR	10	250	590	1 / 40
4725-10GR	10	250	631	1 / 20
4725-12FR	12	300	652	2 / 40
4725-12GR	12	300	693	1 / 20
4725-12BR	12	300	637	2 / 40
4725DKR01	renewal kits		-	-



4725DKR01



4725-10FR
4725-12FR



4725-10GR
4725-12GR

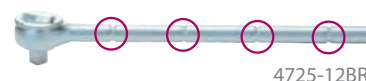

4725-12BR

4755

FINE GEAR 1/2"

- Reversible ratchet
- 5° gear action degree (72 teeth)
- DIN 3122

KT NO.	Overall length			
	inch	mm		
4755-10G	10	262	540	1 / 20
4755DK	renewal kits		-	-



4755DK

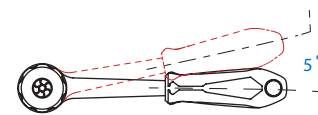

4756

QUICK RELEASE **FINE GEAR** 1/2"

- Quick release reversible ratchet
- 5° gear action degree (72 teeth)
- DIN 3122

KT NO.	Overall length			
	inch	mm		
4756-10G	10	262	539	1 / 20
4756DK	renewal kits		-	-



4756DK

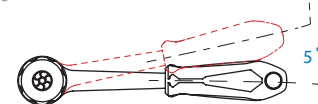

Ratchet

4752

QUICK RELEASE FINE GEAR 1/2"

- Quick release flexible and reversible ratchet
- 5° gear action degree (72 teeth)
- Multi-angle design for difficult-to-reach fasteners

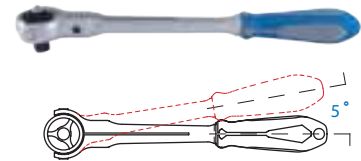
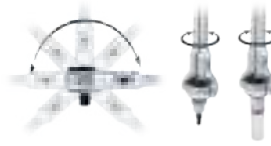

KT NO.	Overall length			
	inch	mm		
4752-12G	12	312	639	1 / 20
4752DK	renewal kits		-	-



4752DK

4760

MINI RATCHET FINE GEAR 1/2"

- Mini reversible ratchet
- 5° gear action degree (72 teeth)
- Two teeth pawl action
- DIN 3122

KT NO.	Overall length			
	inch	mm		
4760-05	4-3/4	120	209	5 / 90
4760-05G	5-1/2	137	201	4 / 72
4760DK01	renewal kits		-	-



4760DK01



4760-05



4760-05G

4762

QUICK RELEASE 1/2"

- Quick release reversible ratchet
- 11° gear action degree (32 teeth)
- Two teeth pawl action
- DIN 3122

KT NO.	Overall length			
	inch	mm		
4762-10G	10	250	536	5 / 30
4762-10F	10	250	580	6 / 36
4762-10P	10	250	552	6 / 36
4762-15G	15	375	693	5 / 20
4762DK	renewal kits		-	-

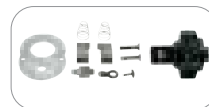

4762DK



4762-10G / 4762-15G



4762-10F



4762-10P

4768

1/2"

- Reversible ratchet
- 11° gear action degree (32 teeth)
- Two teeth pawl action
- DIN 3122

KT NO.	Overall length			
	inch	mm		
4768-10G	10	250	542	5 / 30
4768-10F	10	250	589	6 / 36
4768-10P	10	250	557	6 / 36
4768-15G	15	375	723	5 / 20
4768-15F	15	375	760	6 / 24
4768DK	renewal kits		-	-



4768DK



4768-10G / 4768-15G



4768-10F / 4768-15F



4768-10P

4771

QUICK RELEASE 1/2"

- Quick release reversible ratchet
- 11° gear action degree (32 teeth)
- Two teeth pawl action
- DIN 3122

KT NO.	Overall length			
	inch	mm		
4771-10BR	10	250	551	2 / 40
4771-10FR	10	250	620	2 / 40
4771-10GR	10	262	540	1 / 20
4771DK	renewal kits		-	-



4771DK



4771-10BR



4771-10FR



4771-10GR

Ratchet

KT No. & D1

4774

1/2"

- Universal joint reversible ratchet
- 11° gear action degree (32 teeth)
- Two teeth pawl action
- DIN 3122
- 15° rotation

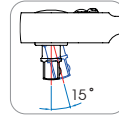

4774-10F



4774-10G



4774DK

KT NO.	Overall length		kg	Crate/Box
	inch	mm		
4774-10F	10	250	619	2 / 40
4774-10G	10	262	553	1 / 20
4774DK	renewal kits		-	-

4779

1/2"

- Reversible ratchet
- 11° gear action degree (32 teeth)
- Two teeth pawl action
- DIN 3122



4779-10BR



4779-10FR



4779-10GR



4779DK01

KT NO.	Overall length		kg	Crate/Box
	inch	mm		
4779-10BR	10	250	559	2 / 40
4779-10FR	10	250	626	2 / 40
4779-10GR	10	262	551	1 / 20
4779DK01	renewal kits		-	-

4772

1/2"

- Design spec. similar to DIN 3122, ISO 3315
- Made from special-purpose drop-forged and hardened **aluminium**
- Finishing - anodic treatment - black driver by phosphate sunk
- The mechanism as in all 4771/9 ratchets is made from high-quality steel



4772DK01

KT NO.	Overall length		kg	Crate/Box
	inch	mm		
4772-10F	10	250	350	1 / 25
4772DK01	renewal kits		-	-

4781

QUICK RELEASE 1/2"

- Quick release flexible and reversible ratchet
- 11° gear action degree (32 teeth)
- Two teeth pawl action
- DIN 3122

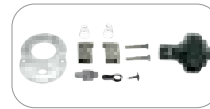

4781DK

KT NO.	Overall length		kg	Crate/Box
	inch	mm		
4781-12F	12	300	783	1 / 20
4781DK	renewal kits		-	-

Ratchet Set

7773GS

QUICK RELEASE 1/2" & 1/4"

- 1/4" & 1/2" DR. 90 teeth dustproof ratchets
- 90 teeth ratchet mechanism, allowing ratchet action in very tight spaces
- IP51, dustproof design



2773-55GS



4773-10GS

Contents		kg	Crate/Box
	2773-55GS	140mm	0.70 / 1 / 36
	4773-10GS	262mm	

90 Teeth Dustproof Ratchet **PAT.**



HAND SOCKET & ACCESSORIES



- Material
 - chrome vanadium alloy steel handle
 - chrome molybdenum steel (gear) driver
- Finishing
 - polished, chrome plated
 - black driver by phosphate sunk



4773-10GS

- Quick release reversible ratchet
- 4° gear action degree (90 teeth)
- DIN 3122
- IP51

KT NO.	Square DR.	Overall length			
		inch	mm		
4773-10GS	1/2"	10	262	500	1 / 25
4773DK				renewal kits	



4773DK

4773-10GS (IP51)

4773-22GS

1/2" DR. Telescopic Ratchet Wrench

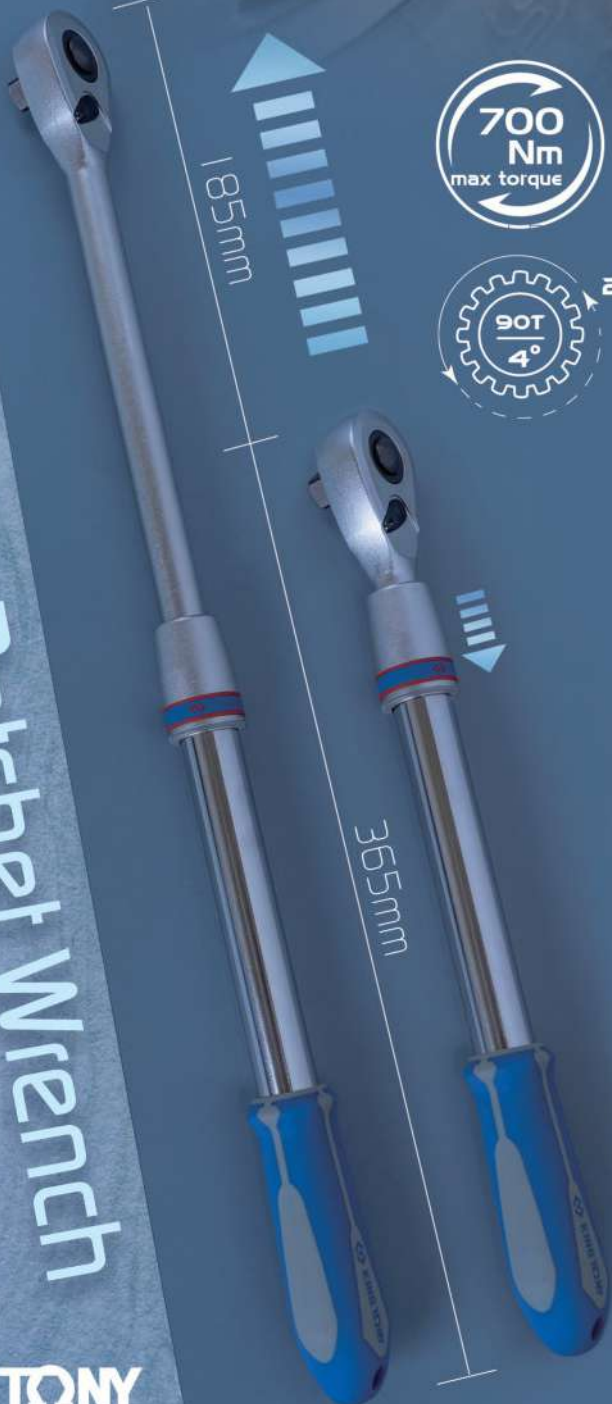

700 Nm
max torque

90T
4°
20%

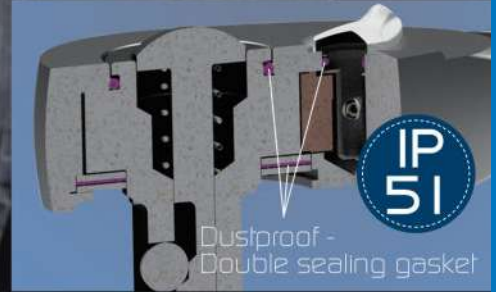

51P



KT NO.	Max L mm	Min L mm		
4773-22GS	550	365	1200	1 / 20
477DK	renewal kits			

- Special telescopic design saves storage space
- Pull down to unlock, fix, and quickly adjust
- Dust-proof design to increase product life
- 700N·m torque value, which far exceeds the standard
- Higher torque, less effort. Extra long lever for increased power: max 550 mm
- The long plastic handle has a hook at its end for hanging and working at height
- 4° gear action degree (90 teeth)



HAND SOCKET & ACCESSORIES

Accessory



The offset extension bar has less strength than normal extension bar. Do not use as a normal extension bar.



4121 1/2"

- Adjustable handle
- Push-Lock design



KT NO.	Overall length		Scales	Boxes
	inch	mm		
4121-11GR	11-1/2	295	535	1 / 20

4251 1/2"

- Extension bar
- DIN 3123



KT NO.	Overall length		Scales	Boxes
	inch	mm		
4251-02R	2	55	105	12 / 216
4251-03R	3	75	143	6 / 120
4251-04R	4	100	182	4 / 80
4251-05R	5	125	197	4 / 80
4251-06R	6	150	231	4 / 64
4251-08R	8	200	294	4 / 80
4251-10R	10	250	364	4 / 64

4104PR 1/2"

- Extension bar

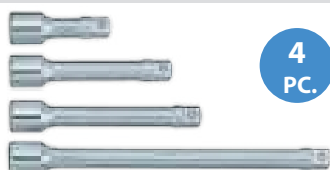

4 PC.

Contents 0.84 1 / 25

KT NO.	3"	5"	6"	10"
4251				

4221 1/2"

- Extension bar
- DIN 3123



KT NO.	Overall length		Scales	Boxes
	inch	mm		
4221-18	18	450	548	1 / 20
4221-24	24	600	685	1 / 20
4221-30	30	750	860	1 / 20
4221-36	36	900	1055	1 / 20

4223 1/2"

- Offset extension bar
- Max. torque : 320 N·m
- DIN 3123



KT NO.	Overall length		Scales	Boxes
	inch	mm		
4223-02R	2	55	98	12 / 216
4223-05R	5	125	194	4 / 80
4223-10R	10	250	358	4 / 64

4293 1/2"

- Multi-function of extension bar and offset extension bar
- Max. torque : 320 N·m
- DIN 3123

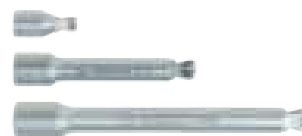

KT NO.	Overall length		Scales	Boxes
	inch	mm		
4293-02	2	55	97	12 / 216
4293-05	5	125	191	4 / 80
4293-10	10	250	356	4 / 64

4311 1/2"

- Speed brace
- DIN 3122



KT NO.	Overall length		Scales	Boxes
	inch	mm		
4311-16F	16-1/4	412	610	5 / 40
4311-16G	16-1/4	412	499	5 / 40

4452 1/2"

- Flexible handle
- Action degree -180°
- DIN 3122



KT NO.	Overall length		Scales	Boxes
	inch	mm		
4452-15FR	15	375	718	2 / 24
4452-18FR	18	450	810	2 / 20
4452DK	renewal kits(for 15F/18F)		62	-

KT NO.	Overall length		Scales	Boxes
	inch	mm		
4452-24FR	24	600	1138	20
4452DK1	renewal kits(for 24F)		62	-

4453 1/2"

- Flexible handle
- Action degree -180°
- New pattern design added in firm and powerful elements
- New forge technologies I-Beam shank offer 15% lightweight
- DIN 3122

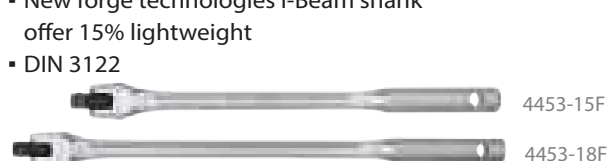

KT NO.	Overall length		Scales	Boxes
	inch	mm		
4453-15F	15	375	630	2 / 24
4453-18F	18	450	708	2 / 20
4452DK	renewal kits(for 15F/18F)		62	-



4462 1/2"

- Extends from 18 in. to 24 in.
- This breaker bar has a 180° swivel head and an ergonomically designed handle
- Break free stubborn or stuck fasteners
- Flexible head for multiple angles of use

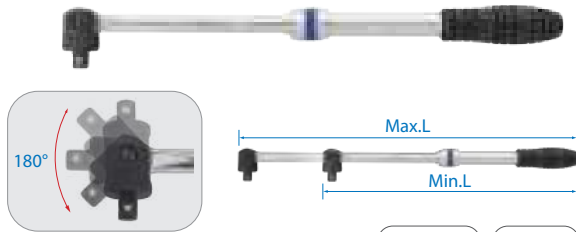

KT NO.	Max.L mm	Min.L mm		
4461-24G	600	450	1185	1 / 10
4462DK	renewal kits			

4462 1/2"

- Flexible handle
- Action degree -180°
- DIN 3122

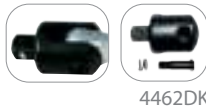

KT NO.	Overall length inch	Overall length mm		
4462-18F	18	463	1046	1 / 20
4462-24F	24	613	1350	1 / 20
4462DK	renewal kits			

4572 1/2"

- Sliding T-handle
- DIN 3122



KT NO.	Overall length inch	Overall length mm		
4572-10	10	250	371	2 / 40
4572-12	12	300	426	2 / 40
4572DK	renewal kits			

4573 1/2"

- Sliding T-handle
- DIN 3120



KT NO.	Overall length inch	Overall length mm		
4573-10R	10	250	470	2 / 40
4573DK	renewal kits			

4581 1/2"

- 90° L-handle
- DIN 3122



KT NO.	Overall length inch	Overall length mm		
4581-10	10	250	450	1 / 40

4583 1/2"

- 105° L-handle
- DIN 3120



KT NO.	Overall length inch	Overall length mm		
4583-12R	12-1/2	315	550	1 / 40

4584 1/2"

- 90° L-handle
- DIN 3120

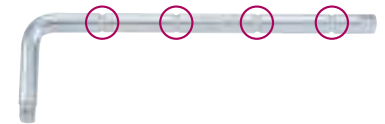

KT NO.	Overall length inch	Overall length mm		
4584-12R	12	300	547	40

4148 1/2"

- Bit holder



KT NO.	Size	Overall length mm		
414808S	1/4"	38	50	10 / 200
414810S	5/16"	38	55	10 / 200
414810M	10 mm	38	56	10 / 200

4813 4816 1/2"

- Adapter
- Convert to 3/8" drive or 3/4" drive
- 4813 → Max. torque : 202 N-m
- DIN 3123, ISO 3316



KT NO.	Spec.		
4813	1/2"Fx3/8"M	56	10 / 200
4816	1/2"Fx3/4"M	111	10 / 200

Accessory

KT No. & D1



HAND SOCKET & ACCESSORIES

4791R 1/2"

- Universal joint
- DIN 3120, ISO 3316

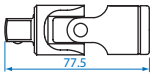

KT NO.	Overall length inch	mm		
4791R	3	77.5	159	5 / 100

4794 1/2"

- Universal joint
- 30° rotation
- Short pattern design enables greater access in confined spaces

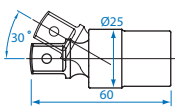

KT NO.	Overall length inch	mm		
4794	2-3/8	60	105	5 / 180

9113PR 1/4" 3/8" 1/2"

- Universal joint
- Ball point type universal joint & with hex locking design
- Short pattern design enables greater access in confined spaces



3 PC.

Contents		
2793 31mm	0.20	6 / 108
3793 43mm		
4793 59mm		

4844R 1/2"

- 1/2" drive (1/2" F x 1/2" M)
- Finish : Chrome Alloy Steel, chrome plated
- Reversible
- 5° gear action degree (72 teeth)
- Apply to 1/2" accessory (Ex : 4453-15F)
- Apply to 1/2" torque wrench (Ex : 3446E series)



PAT.

Outer diameter 37 x Height 62 mm

KT NO.	Overall length inch	mm		
4844R	2-7/16	62	250	1 / 64

KT NO.	Contents		
4122FR	4844R 4453-15F	880	1 / 20
4122FR01	4844R 4453-18F	958	1 / 20

Magnetic Insert

91000M

- Magnetic insert for sockets
- Powerful retention force
- Reusable
- 11 PC. set, for metric sockets

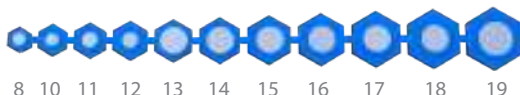
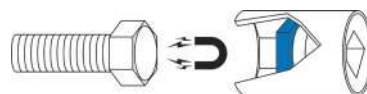

11 PC.

KT NO.	Size (mm)		
91000M	8, 10, 11, 12, 13, 14, 15, 16, 17, 18, 19 mm	42	12 / 144

Socket Rail Set

4010MR

4010SR

4510MR

4510SR 1/2"

▪ Socket rail 230mmL



8 PC.

4010MR/4510MR



4010SR/4510SR

KT NO. Contents 0.64 4 / 32

4010MR	4330MR	10, 12, 13, 14, 17, 19, 21, 22	8740908
4510MR	4335MR		
4010SR	4330SR	3/8, 7/16, 1/2, 9/16, 11/16, 3/4, 13/16, 7/8	
4510SR	4335SR		

4208MR10

4308MR10 1/2"

▪ Socket rail 240mmL



8 PC.

KT NO. Contents 1.22 2 / 12

4208MR10	4230MR	12, 13, 14, 17, 19, 21, 22, 23	8741108
4308MR10	4235MR		

4106PR

1/2"

▪ Socket rail 230mmL



6 PC.

Contents 0.51 4 / 32

4375M	E10, E12, E14, E16, E18, E20
8740906	

4148PR10

1/2"

▪ Socket rail 240mmL



8 PC.

Contents 1.24 2 / 12

4275M	E10, E12, E14, E16, E18, E20, E22, E24
8741108	

4118MR

1/2"

▪ Socket rail 230mmL



8 PC.

Contents 0.57 4 / 32

4014M	RB8, RB9.5, RB10, RB10.5, RB12, RB12.7, RB13.5, RB19
8740908	

4311MR

1/2"

▪ Socket rail 230mmL



11 PC.

Contents 0.92 2 / 12

4335MR	10, 11, 13, 14, 15, 17, 18, 19
4725-10GR	4572-10
4251-05R	8740908

Bit Socket Rail Set

4110PR10

1/2"

▪ Socket rail 240mmL

▪ For hex head screw

▪ H : 60mm



9 PC.

Contents 0.77 2 / 12

4025	H3, H4, H5, H6, H7, H8, H10, H12, H14
8741009	

4110SR10

1/2"

▪ Socket rail 240mmL

▪ For hex head screw

▪ H : 60mm



9 PC.

Contents 1.22 2 / 12

4025S	3/16, 7/32, 1/4, 9/32, 5/16, 3/8, 1/2, 9/16, 5/8
8741009	

Bit Socket Rail Set

4120PR10

1/2"

- Socket rail 240mmL
- For hex head screw
- H : 80mm

9 PC.



Contents

1.0 2 / 12

	4035	H4, H5, H6, H7, H8, H10, H12, H14, H17
8741009		

4108PR10

1/2"

- Socket rail 240mmL
- For hex head screw
- H : 60mm

8 PC.



Contents

0.96 2 / 12

	4025	H6, H7, H8, H10, H12, H14, H17, H19
8741009		

4126PR

1/2"

- Socket rail 127mmL
- For spline head screw
- H : 60mm

4 PC.



Contents

0.38 4 / 32

	4026	M6, M8, M10, M12
8740504		

4105PR

1/2"

- Socket rail 150mmL
- For spline head screw
- H : 60 & 66 mm

5 PC.



Contents

0.57 4 / 32

	4026	M8, M10, M12, M14
	402B	M16
8740605		

4136PR

1/2"

- Socket rail 127mmL
- For spline head screw
- H : 80mm

4 PC.



Contents

0.46 4 / 32

	4036	M6, M8, M10, M12
8740504		

4109PR10

1/2"

- Socket rail 240mmL
- For torx head screw
- H : 60mm

9 PC.



Contents

0.74 2 / 12

	4023	T20, T25, T27, T30, T40, T45, T50, T55, T60
8741009		

4119PR10

1/2"

- Socket rail 240mmL
- For torx head screw
- H : 80mm

9 PC.



Contents

0.84 2 / 2

	4033	T20, T25, T27, T30, T40, T45, T50, T55, T60
8741009		

4116PR

1/2"

- Socket rail 180mmL
- For ribe head screw
- H : 100mm

6 PC.



Contents

0.38 4 / 24

	4049	M9, M10, M12, M13, M14, M16
8740706		

Socket Rail

874

1/2"

- Rail length from 160 mm to 560 mm

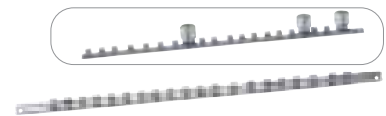

KT NO.

L (mm)

870406		160
870410		260
870422		560
8740		-

8740809D1

1/2"

- Socket rail carrier with retaining clip
- 446mm roller cabinet



KT NO.

Square drive

Clip

L (mm)

8740809D1	1/2"	9	508
-----------	------	---	-----

Socket & Wrench Set

4313MR01 1/2"



13 PC.

Contents 1.55 1 / 12

- 4335MR 8, 10, 11, 12, 13, 14, 15, 16, 17, 18, 19
- 4771-10GR 4251-06R

4213MR 1/2"



11 PC.

Contents 1.39 1 / 15

- 4330MR 10, 11, 12, 13, 14, 17, 19, 21, 22
- 4766-10G 4251-06R



Socket Set

4208MR **4208SR**

4308MR 1/2"

Metal case size (mm) :
246 x 103 x 38 (0.034 cuft)

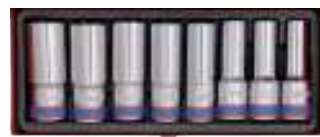

8 PC.

4208MR / 4308MR



4208SR

KT NO. Contents 1.75 1 / 12

KT NO.	Contents	
4208MR	4230M	12, 13, 14, 17, 19, 21, 22, 23
4308MR	4235M	
4208SR	4230S	1/2, 9/16, 5/8, 11/16, 3/4, 13/16, 7/8, 15/16

4215MR **4315MR** 1/2"

Metal case size (mm) :
445 x 135 x 50 (0.107 cuft)

15 PC.

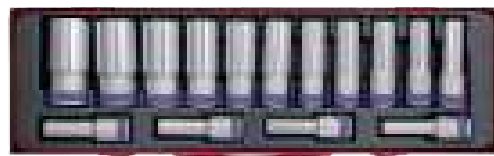

KT NO. Contents 3.80 1 / 6

KT NO.	Contents	
4215MR	4230M	10, 11, 12, 13, 14, 15, 16, 17, 19, 21, 22, 24, 27, 30, 32
4315MR	4235M	

4216MR **4316MR** 1/2"

Metal case size (mm) :
445 x 135 x 50 (0.107 cuft)

16 PC.

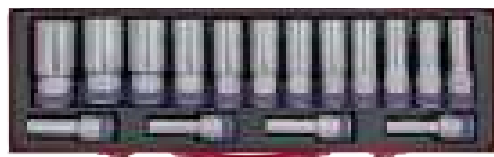

KT NO. Contents 3.68 1 / 6

KT NO.	Contents	
4216MR	4230M	10, 11, 12, 13, 14, 15, 16, 17, 18, 19, 21, 22, 24, 27, 30, 32
4316MR	4235M	

Bit Socket Set

4109PR

Metal case size (mm) :
198 x 105 x 32 (0.023 cuft)

9
PC.



4109PR

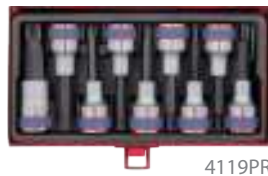

4119PR

KT NO.	Contents	kg	1/6
4109PR	4023 T20, T25, T27, T30, T40, T45, T50, T55, T60	1.04	1 / 20
4119PR	4033	1.13	1 / 20

4110PR

Metal case size (mm) :
198 x 105 x 32 (0.023 cuft)

9
PC.



4110PR



4120PR

KT NO.	Contents	kg	1/6
4110PR	4025 H3, H4, H5, H6, H7, H8, H10, H12, H14	1.03	1 / 20
4120PR	4035 H4, H5, H6, H7, H8, H10, H12, H14, H17	1.38	1 / 20

4117PR

Metal case size (mm) :
224 x 94 x 40 (0.03 cuft)

7
PC.



Contents

kg 1.22 1/8

- 4026 M6, M8, M10, M12, M14
- 402B M16, M18

4128PR

Metal case size (mm) :
224 x 94 x 40 (0.03 cuft)

8
PC.



Contents

kg 1.24 1/8

- 4026 M5, M6, M8, M10
- 402B M16
- 4036 M8, M10, M12

Socket Set

4501MR

Metal case size (mm) :
392 x 90 x 50 (0.062 cuft)

15
PC.



Contents

kg 3.28 1/6

- 4335MR 8, 10, 11, 12, 13, 14, 17, 19, 21, 22, 24, 27
- 4779-10FR 4251-05R
- 4452-15FR

4511MR

Metal case size (mm) :
445 x 187 x 50 (0.147 cuft)

24
PC.

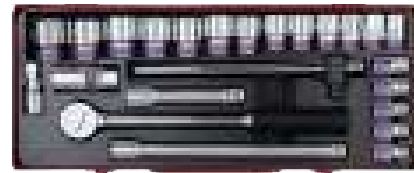

4511MR

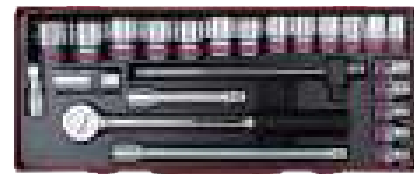

4511SR

KT NO. Contents kg 5.5 1/4

4511MR	4335MR	10, 11, 12, 13, 14, 15, 16, 17, 18, 19, 20, 21, 22, 23, 24, 27, 30, 32	463521RC 4725-12GR
4511SR	4335SR	3/8, 7/16, 15/32, 1/2, 9/16, 19/32, 5/8, 11/16, 3/4, 25/32, 13/16, 7/8, 15/16, 1, 1-1/16, 1-1/8, 1-3/16, 1-1/4	4572-10 4251-05R 4251-10R 4223-02R

Socket Set

4012MR

Metal case size (mm) :
445 x 135 x 50 (0.106 cuft)

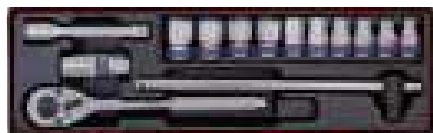

4012MR / 4512MR

4012SR

4512MR

4512SR

1/2"



4012SR / 4512SR

14
PC.

KT NO.	Contents		Kg 3.50	1 / 6
4012MR	4330MR	10, 11, 12, 13, 14, 17, 19, 21, 22, 24	463021RC	4768-10F
4512MR	4335MR		463521RC	4572-12
4012SR	4330SR	3/8, 7/16, 15/32, 1/2, 9/16, 11/16, 3/4, 13/16, 7/8, 15/16	463021RC	4251-05R
4512SR	4335SR		463521RC	

4016SR

Metal case size (mm) :
370 x 150 x 54 (0.105 cuft)

4516MR

4516SR

1/2"



4516MR



4016SR / 4516SR

16
PC.

KT NO.	Contents		Kg 3.68	1 / 6
4016SR	4330SR	3/8, 7/16, 1/2, 9/16, 5/8, 11/16, 3/4, 13/16, 7/8, 15/16, 1-1/16	463021RC	4791R 4779-10FR
4516MR	4335MR	10, 11, 12, 13, 14, 17, 19, 21, 23, 24, 27	463521RC	4251-05R
4516SR	4335SR	3/8, 7/16, 15/32, 1/2, 9/16, 5/8, 3/4, 13/16, 15/16, 1, 1-1/16	463521RC	4452-15FR

4220MR

Metal case size (mm) :
445 x 135 x 50 (0.106 cuft)

KT NO. Contents Kg 3.83 1 / 6

4220MR	4330MR	8, 9, 10, 11, 12, 13, 14, 15, 16, 17, 18, 19, 21, 22, 24, 27	4755-10G	
4320MR	4335MR		4251-05R 4251-10R	4791R



20
PC.

4223MR

Metal case size (mm) :
490 x 205 x 52 (0.185 cuft)

Contents Kg 4.7 1 / 3

4330MR	10, 11, 12, 13, 14, 15, 16, 17, 18, 19, 21, 22, 23, 24, 27, 30, 32, 34
4771-10G	4461-24G
4791R	4251-05R

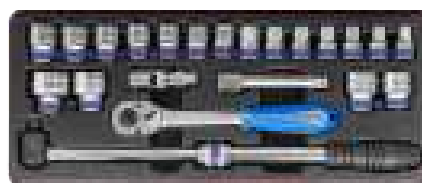

22
PC.

Socket Set

4031MR

4031SR

4531MR

4531SR

1/2"

Metal case size (mm) :
445 x 187 x 50 (0.147 cuft)



4031MR / 4531MR















4031SR / 4531SR

23
PC.

KT NO.

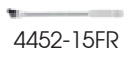
Contents

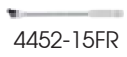
5.3 1/4

KT NO.	Contents	5.3 1/4
4031MR	 4330MR 10, 11, 12, 13, 14, 15, 16, 17, 18, 19, 20, 21, 22, 23, 24, 27, 30, 32	 4779-10GR  4251-05R  4251-10R
4531MR	 4335MR 10, 11, 12, 13, 14, 15, 16, 17, 18, 19, 20, 21, 22, 23, 24, 27, 30, 32	 4779-10GR  4251-05R  4251-10R
4031SR	 4330SR 5/16, 3/8, 7/16, 15/32, 1/2, 9/16, 19/32, 5/8, 11/16, 3/4, 25/32, 13/16, 7/8, 15/16, 1, 1-1/16, 1-3/16, 1-1/4	 4452-15FR  4791R
4531SR	 4335SR 5/16, 3/8, 7/16, 15/32, 1/2, 9/16, 19/32, 5/8, 11/16, 3/4, 25/32, 13/16, 7/8, 15/16, 1, 1-1/16, 1-3/16, 1-1/4	 4452-15FR  4791R

4024MR

4024SR

4524MR

4524SR

4033MR

4033SR

4533MR

4533SR

1/2"

Metal case size (mm) :
445 x 187 x 50 (0.147 cuft)



4024SR / 4524SR



4024MR / 4524MR

24
PC.



4033SR / 4533SR

































4033MR / 4533MR

KT NO.

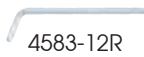
Contents

5.7 1/4

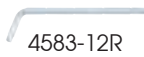
KT NO.	Contents	5.7 1/4
4033SR	 4330SR 5/16, 3/8, 7/16, 15/32, 1/2, 9/16, 19/32, 5/8, 11/16, 3/4, 25/32, 13/16, 7/8, 15/16, 1, 1-1/16, 1-3/16, 1-1/4	 463021RC  4779-10BR  4121-11GR
4533SR	 4335SR 5/16, 3/8, 7/16, 15/32, 1/2, 9/16, 19/32, 5/8, 11/16, 3/4, 25/32, 13/16, 7/8, 15/16, 1, 1-1/16, 1-3/16, 1-1/4	 463521RC  4779-10BR  4121-11GR
4033MR	 4330MR 10, 11, 12, 13, 14, 15, 16, 17, 18, 19, 20, 21, 22, 23, 24, 27, 30, 32	 463021RC  4779-10BR  4121-11GR
4533MR	 4335MR 10, 11, 12, 13, 14, 15, 16, 17, 18, 19, 20, 21, 22, 23, 24, 27, 30, 32	 463521RC  4779-10BR  4121-11GR
4024SR	 4330SR 3/8, 7/16, 15/32, 1/2, 9/16, 19/32, 5/8, 11/16, 3/4, 25/32, 13/16, 7/8, 15/16, 1, 1-1/16, 1-1/8, 1-3/16, 1-1/4	 463021RC  4779-10BR  4121-11GR
4524SR	 4335SR 3/8, 7/16, 15/32, 1/2, 9/16, 19/32, 5/8, 11/16, 3/4, 25/32, 13/16, 7/8, 15/16, 1, 1-1/16, 1-1/8, 1-3/16, 1-1/4	 463521RC  4779-10BR  4121-11GR
4024MR	 4330MR 10, 11, 12, 13, 14, 15, 16, 17, 18, 19, 20, 21, 22, 23, 24, 27, 30, 32	 463021RC  4725-12BR  4583-12R
4524MR	 4335MR 10, 11, 12, 13, 14, 15, 16, 17, 18, 19, 20, 21, 22, 23, 24, 27, 30, 32	 463521RC  4725-12BR  4583-12R

Socket Set

4224MR

4324MR

1/2"

Metal case size (mm) :
445 x 187 x 50 (0.147 cuft)



24
PC.

4224MR / 4324MR

KT NO.

Contents

5.3 1 / 4

4224MR	 4330MR	10, 11, 12, 13, 14, 15, 16, 17, 18, 19, 20, 21, 22, 23, 24, 27, 30, 32					
4324MR	 4335MR		4779-10GR	4452-18FR	4572-12	4251-05R 4251-10R	4791R

4028MR

4028SR

4528MR

4528SR

1/2"

Metal case size (mm) :
445 x 187 x 50 (0.147 cuft)



4028MR / 4528MR



















4028SR / 4528SR

24
PC.

KT NO.

Contents

5.3 1 / 4

4028MR	 4330MR	10, 11, 12, 13, 14, 15, 16, 17, 18, 19, 20, 21, 22, 23, 24, 27, 30, 32	 463021RC		
4528MR	 4335MR		 463521RC		
4028SR	 4330SR	3/8, 7/16, 15/32, 1/2, 9/16, 19/32, 5/8, 11/16, 3/4, 25/32, 13/16, 7/8, 15/16, 1, 1-1/16, 1-1/8, 1-3/16, 1-1/4	 463021RC		
4528SR	 4335SR		 463521RC		

4032MR

4032SR

4532MR

4532SR

1/2"

Metal case size (mm) :
445 x 187 x 50 (0.147 cuft)



4032MR / 4532MR





















4032SR / 4532SR

24
PC.

KT NO.

Contents

5.3 1 / 4

4032MR	 4330MR	10, 11, 12, 13, 14, 15, 16, 17, 18, 19, 20, 21, 22, 23, 24, 27, 30, 32	 463021RC			
4532MR	 4335MR		 463521RC			
4032SR	 4330SR	5/16, 3/8, 7/16, 15/32, 1/2, 9/16, 19/32, 5/8, 11/16, 3/4, 25/32, 13/16, 7/8, 15/16, 1, 1-1/16, 1-3/16, 1-1/4	 463021RC			
4532SR	 4335SR		 463521RC			

Socket Set











4325MR

1/2"

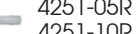
Metal case size (mm) :
445 x 187 x 50 (0.147 cuft)

Contents

5.3 1 / 4

		4335MR	10, 11, 12, 13, 14, 15, 16, 17, 18, 19, 20, 21, 22, 23, 24, 27, 30, 32
		4779-10GR	
		4251-05R 4251-10R	
		4791R	
		4311-16G	
		4572-10	



24 PC.

4026MR

4026SR

4526MR

4526SR

4026MR03

4026SR03

4526MR03

4526SR03

4026MR04

1/2"

Metal case size (mm) :
445 x 187 x 50 (0.147 cuft)



4026MR / 4526MR



4026SR / 4526SR



4026SR03 / 4526SR03



4026MR03 / 4526MR03











4026MR04

24 PC.

KT NO.

Contents

5.95 1 / 4

KT NO.	Contents	Weight	Volume
4026MR	 4330MR	5.95	1 / 4
4526MR	 4335MR		
4026MR03	 4330MR	5.95	1 / 4
4526MR03	 4335MR		
4026MR04	 4330MR		
4026SR	 4330SR	5.95	1 / 4
4526SR	 4335SR		
4026SR03	 4330SR	5.95	1 / 4
4526SR03	 4330MR		

KT NO.	Contents	Weight	Volume
4026MR	10, 11, 12, 13, 14, 15, 16, 17, 18, 19, 20, 21, 22, 23, 24, 27, 30, 32	5.95	1 / 4
4526MR	10, 11, 12, 13, 14, 15, 16, 17, 18, 19, 20, 21, 22, 23, 24, 27, 30, 32		
4026MR03	8, 10, 11, 13, 14, 15, 16, 17, 18, 19, 20, 21, 22, 23, 24, 27, 30, 32	5.95	1 / 4
4526MR03	8, 10, 11, 13, 14, 15, 16, 17, 18, 19, 20, 21, 22, 23, 24, 27, 30, 32		
4026MR04	8, 10, 11, 13, 14, 15, 16, 17, 18, 19, 20, 21, 22, 23, 24, 27, 30, 32		
4026SR	5/16, 3/8, 7/16, 15/32, 1/2, 9/16, 19/32, 5/8, 11/16, 3/4, 25/32, 13/16, 7/8, 15/16, 1, 1-1/16, 1-3/16, 1-1/4	5.95	1 / 4
4526SR	5/16, 3/8, 7/16, 15/32, 1/2, 9/16, 19/32, 5/8, 11/16, 3/4, 25/32, 13/16, 7/8, 15/16, 1, 1-1/16, 1-3/16, 1-1/4		
4026SR03	5/16, 3/8, 7/16, 15/32, 1/2, 9/16, 19/32, 5/8, 11/16, 3/4, 25/32, 13/16, 7/8, 15/16, 1, 1-1/16, 1-3/16, 1-1/4	5.95	1 / 4
4526SR03	5/16, 3/8, 7/16, 15/32, 1/2, 9/16, 19/32, 5/8, 11/16, 3/4, 25/32, 13/16, 7/8, 15/16, 1, 1-1/16, 1-3/16, 1-1/4		

Socket Set

4033MR03

Metal case size (mm) :
445 x 187 x 50 (0.147 cuft)









4533MR03

1/2"

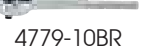

24
PC.

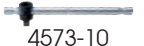
4033MR03 / 4533MR03

KT NO.			Contents	4.43	1 / 4	
4033MR03		4330MR	10, 11, 12, 13, 14, 15, 16, 17, 18, 19, 20, 21, 22, 23, 24, 27, 30, 32	 4791R	 4779-10BR	 4223-02R
4533MR03		4335MR		 4121-11GR	 4573-10	 4583-12R

4030CR

Metal case size (mm) :
445 x 187 x 50 (0.147 cuft)

4030CR01

1/2"









4030CR

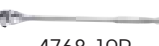

4030CR01

30
PC.

KT NO.			Contents	4.90	4.92	1 / 4
4030CR		4330MR	10, 12, 13, 14, 15, 16, 17, 18, 19, 21, 22, 23, 24, 30, 32	 4768-10P	 4452-15FR	 4791R
4030CR01		4330SR	7/16, 1/2, 9/16, 5/8, 11/16, 3/4, 13/16, 7/8, 15/16, 1	 4779-10GR	 4251-05R	 4813

4034MR

4034MR06

4534MR

4534MR06

1/2"

Metal case size (mm) :
476 x 282 x 57 (0.27 cuft)





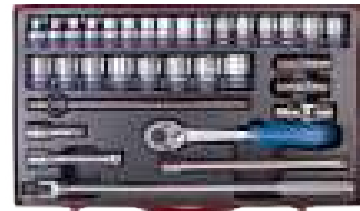







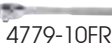
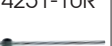

4034MR / 4534MR



4034MR06 / 4534MR06

33
PC.

KT NO.			Contents	7.6	7.9	1 / 2
4034MR		4330MR	 463021RC	 463516RC	4251-03R 4251-05R 4251-10R	1 / 2
4534MR		4335MR	 463521RC	 4779-10FR	 4572-12	
4034MR06		4330MR	8, 9, 10, 11, 12, 13, 14, 15, 16, 17, 18, 19, 20, 21, 22, 23, 24, 25, 26, 27, 28, 29, 30, 32	 463014RC	 4779-10GR	 4452-18FR
4534MR06		4335MR		 463016RC		 4791R

Socket Set

4535MR

1/2"

Metal case size (mm) :
445 x 187 x 50 (0.147 Cuft)

Contents

4.46 1 / 4

	4335MR	10, 11, 12, 13, 14, 15, 17, 19, 21, 22, 24, 27, 30, 32
	1836H	H5, H6, H7, H8, H10, H12
	1836T	T25, T27, T30, T40, T45, T50
	1836P	PH2, PH3
	463516RC	463514RC
	4251-05R 4251-10R	4771-10GR 4794 414810S

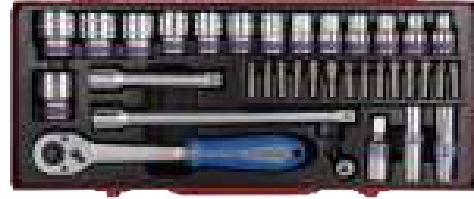

35 PC.

4042CR

4042CR02

4542CR

4542CR02

1/2"

Metal case size (mm) :
476 x 282 x 57 (0.27 cuft)

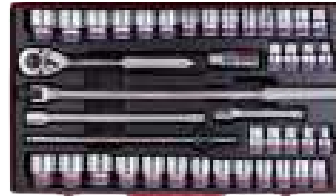

4042CR / 4542CR

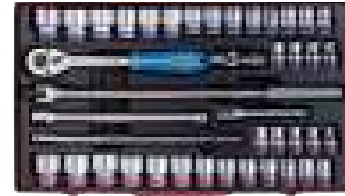

4042CR02 / 4542CR02

42 PC.

KT NO.

Contents

8.5 1 / 2

KT NO.	Contents	Weight	Box Qty
4042CR	4330MR 4330SR 10, 11, 12, 13, 14, 15, 16, 17, 18, 19, 20, 21, 22, 23, 24, 27, 30, 32	8.5	1 / 2
4542CR	4335MR 4335SR 5/16, 3/8, 7/16, 1/2, 9/16, 19/32, 5/8, 11/16, 3/4, 25/32, 13/16, 7/8, 15/16, 1, 1-1/16, 1-1/8, 1-3/16, 1-1/4		
4042CR02	4330MR 4330SR		
4542CR02	4335MR 4335SR		
	463021RC 4768-10F 463521RC		
	4779-10GR 4791R		
	4452-18FR 4251-05R 4251-10R 4572-12		

4044CR

4544CR

1/2"

Metal case size (mm) :
476 x 282 x 57 (0.27 cuft)

KT NO. Contents

8.5 1 / 2

4044CR	4330MR 8, 9, 10, 11, 12, 13, 14, 15, 16, 17, 18, 19, 20, 21, 22, 23, 24, 25, 26, 27, 28, 30, 32	4779-10BR 4573-10 4121-11GR
	4330SR 3/8, 7/16, 1/2, 9/16, 5/8, 11/16, 3/4, 13/16, 7/8, 15/16, 1, 1-1/8, 1-3/16, 1-1/4	4583-12R 4791R
	4335MR 8, 9, 10, 11, 12, 13, 14, 15, 16, 17, 18, 19, 20, 21, 22, 23, 24, 25, 26, 27, 28, 30, 32	4223-02R
4544CR	4335SR 3/8, 7/16, 1/2, 9/16, 5/8, 11/16, 3/4, 13/16, 7/8, 15/16, 1, 1-1/8, 1-3/16, 1-1/4	

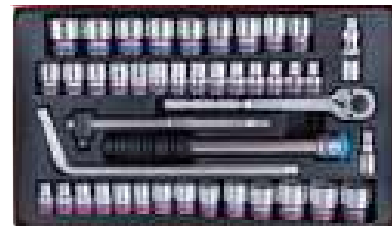

43 PC.

Socket Set

4523MRV01

Tray category #8 (375 x 187mm) 1/2"

Plastic case size (mm) :
389 x 230 x 66 (0.208 Cuft)

Contents

3.88 kg 1 / 6

○		4335MR	8, 9, 10, 11, 12, 13, 14, 15, 16, 17, 18, 19, 21, 22, 24, 27, 30, 32
		4771-10GR	4791R
		4572-10	4251-05R 4251-10R

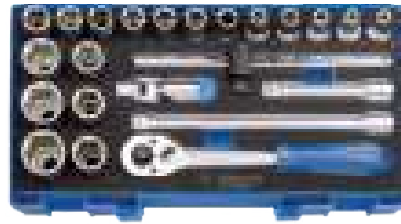

23 PC.

Socket & Tool Set

4524MRV04

Tray category #8 (375 x 187mm) 1/2"

Plastic case size (mm) :
389 x 230 x 66 (0.208 Cuft)

Contents

5.08 kg 1 / 4

○		4335MR	8, 10, 11, 12, 13, 14, 15, 16, 17, 18, 19, 21, 22, 23, 24, 27, 28, 30, 32
		4251R	5, 10
		4793	
		4572-12	
		4773-22GS	

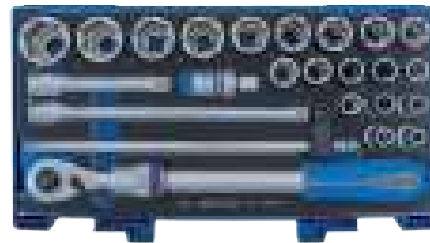

24 PC.

4526MR15

1/2"

Blow case size (mm) :
422 x 275 x 85 (0.35 cuft)

Contents

5.05 kg 1 / 4

○		4335MR	8, 10, 11, 12, 13, 14, 15, 16, 17, 18, 19, 21, 22, 23, 24, 27, 30, 32
		4779-10FR	4572-12
		4452-15FR	4791R
		4251-05R	4251-10R

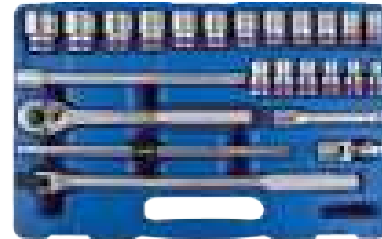

24 PC.

4047MR

Blow case size (mm) :
422 x 275 x 85 (0.35 cuft)

KT NO.	Contents	6.62 kg 1 / 2
4047MR	○ 4330MR	10, 11, 12, 13, 14, 15, 16, 17, 18, 19, 20, 21, 22, 23, 24, 27, 30, 32
4547MR	○ 4335MR	4251-05R 4452-15FR 4251-10R 4791R 4572-12 4791R 4768-10F 463521RC 6111-07 6311-06

4547MR

1/2"



47 PC.

Socket Set

4306MRN

1/2"

Contents

2.28 1 / 8

	4335MR	17, 19
	4121-11GR	4251-03R
	4584-12R	4725-12BR



6 PC.



Impact Driver Set



CAUTION Please wear proper safety gear while working.



4108FR

4111FR

4112FR

1/2"

Metal case size (mm) :
190 x 60 x 48 (0.019 cuft)



414810S



4112



4108FR



4111FR



4112FR

KT NO.	PC.	Contents				
4108FR	8	1836S 9, 11	1836P PH2, PH3	1880P PH2, PH3	4112	1.04
4111FR	6	1880S 8, 10	1880P PH2, PH3		414810S	1.00
4112FR	6	1836S 9, 11	1836P PH2, PH3			1.00
						1 / 24

4505MR

4505SR

1/2"

Metal case size (mm) :
246 x 103 x 38 (0.034 cuft)



10 PC.



10 PC.

KT NO.	Contents		
4505MR	4335MR 8, 10, 12, 14	1.6	1 / 12
4505SR	4335SR 5/16, 3/8, 1/2, 9/16		
		1836S 9, 11	1836P PH2, PH3
		4112	414810S

4116FR01

3/4"

- 3/4"DR. impact driver with knurled grip
- Instant impact force releases rusted or frozen screws without damaging them
- Forward and reverse drive direction
- Comfortable handle with non-slip knurled handle
- Can be used anywhere, no air or power source required
- Max torque: 512N.m for 1/2" DR. convert adapter

1.27 1 / 20

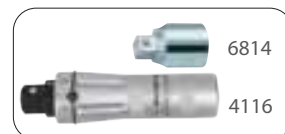

6814



4116



Standard Socket

6330M

▪ Metric-DIN 3124, ISO 2725-1

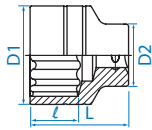

3/4"



6330S

▪ Inch-ANSI / ASME B107.1

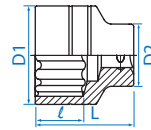

3/4"



KT NO.	mm	D1 mm	D2 mm	ℓ mm	L mm	⚖	📦
633017M	17	26.0	32.7	14	51	144	8 / 96
633019M	19	30.0	32.7	14	51	164	8 / 96
633021M	21	32.0	32.7	16	51	169	8 / 96
633022M	22	33.0	35.7	16	51	204	8 / 96
633023M	23	34.0	35.7	16	51	210	8 / 96
633024M	24	35.0	35.7	17	51	209	8 / 96
633026M	26	35.7	35.0	17	52	196	8 / 96
633027M	27	38.0	36.0	19	52	219	8 / 96
633028M	28	39.0	36.0	19	52	220	8 / 96
633029M	29	40.0	38.0	19	52	245	8 / 96
633030M	30	42.0	38.0	21	54	274	6 / 48
633032M	32	44.0	38.0	23	56	297	6 / 48
633033M	33	46.0	39.0	23	56	330	6 / 48
633034M	34	47.0	42.0	24	57	377	6 / 48
633035M	35	48.0	42.0	25	58	393	6 / 36
633036M	36	50.0	42.0	25	58	420	6 / 36
633038M	38	52.0	45.0	27	60	468	6 / 36
633041M	41	56.0	45.0	29	64	549	4 / 32
633042M	42	57.0	45.0	29	64	541	4 / 32
633046M	46	62.0	48.0	33	68	673	4 / 32
633048M	48	64.0	48.0	34	70	689	2 / 24
633050M	50	68.0	48.0	34	72	840	2 / 24
633054M	54	72.0	50.0	35	75	943	1 / 20
633055M	55	74.0	50.0	37	76	989	1 / 20
633058M	58	77.0	50.0	37	78	1044	1 / 20
633060M	60	80.0	50.0	40	78	1072	1 / 20
633063M	63	83.0	55.0	40	81	1201	1 / 12
633065M	65	85.0	58.0	43	83	1311	1 / 12
633070M	70	92.0	58.0	46	88	1634	1 / 12

KT NO.	inch	D1 mm	D2 mm	ℓ mm	L mm	⚖	📦
633022S	11/16	26	35.7	14	50.8	144	8 / 96
633024S	3/4	30	35.7	14	50.8	164	8 / 96
633026S	13/16	32	35.7	16	50.8	169	8 / 96
633028S	7/8	33	35.7	16	51.0	206	8 / 96
633030S	15/16	35	35.7	17	51.0	213	8 / 96
633032S	1	35	35.7	17	52.0	208	8 / 96
633034S	1-1/16	38	36.0	19	52.0	219	8 / 96
633036S	1-1/8	40	38.0	19	52.0	244	8 / 96
633038S	1-3/16	42	38.0	21	54.0	273	6 / 48
633040S	1-1/4	44	38.0	23	56.0	299	6 / 48
633042S	1-5/16	46	39.0	23	56.0	331	6 / 48
633044S	1-3/8	48	42.0	25	58.0	393	6 / 36
633046S	1-7/16	50	42.0	25	58.0	412	6 / 36
633048S	1-1/2	52	45.0	27	60.0	477	6 / 36
633050S	1-9/16	54	45.0	28	62.0	493	4 / 32
633052S	1-5/8	56	45.0	29	64.0	564	4 / 32
633054S	1-11/16	58	45.0	29	65.0	562	4 / 32
633056S	1-3/4	60	48.0	31	66.0	636	4 / 32
633058S	1-13/16	62	48.0	34	68.0	669	4 / 32
633060S	1-7/8	64	48.0	34	70.0	712	2 / 24
633062S	1-15/16	66	48.0	34	70.0	768	2 / 24
633064S	2	68	48.0	34	72.0	826	2 / 24
633066S	2-1/16	70	50.0	35	74.0	893	1 / 20
633068S	2-1/8	72	50.0	35	75.0	944	1 / 20
633070S	2-3/16	74	50.0	37	76.0	957	1 / 20
633072S	2-1/4	76	50.0	37	76.0	962	1 / 20
633074S	2-5/16	78	50.0	37	78.0	1084	1 / 20
633076S	2-3/8	80	50.0	40	78.0	1093	1 / 20
633078S	2-7/16	82	55.0	40	81.0	1160	1 / 12
633080S	2-1/2	84	55.0	40	81.0	1238	1 / 12
633082S	2-9/16	85	58.0	43	83.0	1355	1 / 12
633084S	2-5/8	86	58.0	43	83.0	1277	1 / 12
633086S	2-11/16	90	58.0	43	85.0	1514	1 / 12
633088S	2-3/4	92	58.0	46	88.0	1642	1 / 12



Standard Socket

6335M

3/4"

▪ DIN 3124, ISO 2725-1

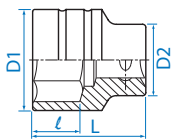

KT NO.	mm	D1 mm	D2 mm	l mm	L mm		
633517M	17	26.0	32.7	14	51	147	8 / 96
633518M	18	28.0	32.7	14	51	155	8 / 96
633519M	19	30.0	32.7	14	51	168	8 / 96
633520M	20	31.0	32.7	16	51	169	8 / 96
633521M	21	32.0	32.7	16	51	173	8 / 96
633522M	22	33.0	35.7	16	51	208	8 / 96
633523M	23	34.0	35.7	16	51	211	8 / 96
633524M	24	35.0	35.7	17	51	216	8 / 96
633525M	25	35.0	35.7	17	52	211	8 / 96
633526M	26	35.7	35.0	17	52	199	8 / 96
633527M	27	38.0	36.0	19	52	226	8 / 96
633528M	28	39.0	36.0	19	52	230	8 / 96
633529M	29	40.0	38.0	19	52	252	8 / 96
633530M	30	42.0	38.0	21	54	287	6 / 48
633531M	31	43.0	38.0	23	55	295	6 / 48
633532M	32	44.0	38.0	23	56	308	6 / 48
633533M	33	46.0	39.0	23	56	345	6 / 48
633534M	34	47.0	42.0	24	57	392	6 / 48
633535M	35	48.0	42.0	25	58	403	6 / 36
633536M	36	50.0	42.0	25	58	438	6 / 36
633537M	37	51.0	45.0	25	59	471	6 / 36
633538M	38	52.0	45.0	27	60	491	6 / 36
633539M	39	53.0	45.0	28	61	499	4 / 32
633540M	40	54.0	45.0	28	62	512	4 / 32
633541M	41	56.0	45.0	29	64	571	4 / 32
633542M	42	57.0	45.0	29	64	573	4 / 32
633543M	43	58.0	45.0	29	65	591	4 / 32
633544M	44	60.0	48.0	31	66	689	4 / 32
633545M	45	61.0	48.0	33	67	687	4 / 32
633546M	46	62.0	48.0	33	68	708	4 / 32
633547M	47	63.0	48.0	33	69	729	4 / 32
633548M	48	64.0	48.0	34	70	708	2 / 24
633549M	49	66.0	48.0	34	70	808	2 / 24
633550M	50	68.0	48.0	34	72	891	2 / 24
633551M	51	69.0	50.0	35	73	911	1 / 20
633552M	52	69.0	50.0	35	73	873	1 / 20
633553M	53	70.0	50.0	35	74	904	1 / 20
633554M	54	72.0	50.0	35	75	968	1 / 20
633555M	55	74.0	50.0	37	76	1025	1 / 20
633556M	56	75.0	50.0	37	76	1052	1 / 20
633557M	57	76.0	50.0	37	76	1017	1 / 20
633558M	58	77.0	50.0	37	78	1067	1 / 20
633559M	59	78.0	50.0	37	78	1127	1 / 20
633560M	60	80.0	50.0	40	78	1145	1 / 20
633562M	62	82.0	55.0	40	81	1258	1 / 12
633563M	63	83.0	55.0	40	81	1304	1 / 12
633564M	64	84.0	55.0	40	81	1300	1 / 12
633565M	65	85.0	58.0	43	83	1422	1 / 12
633570M	70	92.0	58.0	46	88	1800	1 / 12

Deep Socket

KT No. & D1

6230M

3/4"

▪ DIN 3124, ISO 2725-1

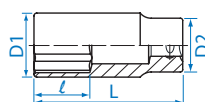

KT NO.	mm	D1 mm	D2 mm	l mm	L mm		
623030M	30	42.0	38.0	31	90	584	1 / 24
623032M	32	44.0	38.0	34	90	568	1 / 24
623033M	33	46.0	39.0	34	90	542	1 / 24
623036M	36	50.0	42.0	37	90	608	1 / 24
623039M	39	53.0	45.0	41	90	666	1 / 24
623041M	41	56.0	45.0	41	90	701	1 / 24
623046M	46	62.0	48.0	46	95	889	1 / 10
623050M	50	68.0	48.0	50	95	1022	1 / 10

6235M

3/4"

▪ DIN 3124, ISO 2725-1

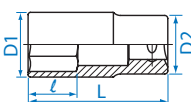

KT NO.	mm	D1 mm	D2 mm	l mm	L mm		
623517M	17	26.0	32.7	20	90	275	2 / 48
623518M	18	28.0	32.7	20	90	345	2 / 48
623519M	19	30.0	32.7	20	90	325	2 / 48
623520M	20	31.0	32.7	22	90	373	2 / 48
623521M	21	32.0	32.7	22	90	335	2 / 48
623522M	22	33.0	35.7	22	90	391	2 / 48
623523M	23	34.0	35.7	24	90	390	2 / 48
623524M	24	35.0	35.7	24	90	406	2 / 48
623525M	25	35.0	35.7	25	90	399	2 / 48
623526M	26	35.7	35.0	25	90	353	1 / 24
623527M	27	38.0	36.0	28	90	389	1 / 24
623528M	28	39.0	36.0	28	90	397	1 / 24
623529M	29	40.0	38.0	28	90	428	1 / 24
623530M	30	42.0	38.0	31	90	469	1 / 24
623531M	31	43.0	38.0	34	90	472	1 / 24
623532M	32	44.0	38.0	34	90	490	1 / 24
623533M	33	46.0	39.0	34	90	549	1 / 24
623534M	34	47.0	42.0	34	90	591	1 / 24
623535M	35	48.0	42.0	37	90	583	1 / 24
623536M	36	50.0	42.0	37	90	632	1 / 24
623537M	37	51.0	45.0	37	90	687	1 / 24
623538M	38	52.0	45.0	41	90	673	1 / 24
623539M	39	53.0	45.0	41	90	689	1 / 24
623540M	40	54.0	45.0	41	90	713	1 / 24
623541M	41	56.0	45.0	41	90	753	1 / 24
623542M	42	57.0	45.0	46	95	794	1 / 24
623543M	43	58.0	45.0	46	95	816	1 / 10
623544M	44	60.0	48.0	46	95	920	1 / 10
623545M	45	61.0	48.0	46	95	932	1 / 10
623546M	46	62.0	48.0	46	95	940	1 / 10
623547M	47	63.0	48.0	46	95	961	1 / 10
623548M	48	64.0	48.0	50	95	948	1 / 10
623549M	49	66.0	48.0	50	95	1015	1 / 10
623550M	50	68.0	48.0	50	95	1064	1 / 10
623551M	51	69.0	50.0	50	95	1114	1 / 10
623552M	52	69.0	50.0	50	95	1109	1 / 10
623553M	53	70.0	50.0	50	95	1119	1 / 10
623554M	54	72.0	50.0	50	95	1170	1 / 10
623555M	55	74.0	50.0	50	95	1236	1 / 10
623556M	56	75.0	50.0	50	95	1272	1 / 10
623557M	57	76.0	50.0	52	100	1392	1 / 10
623558M	58	78.0	50.0	52	100	1446	1 / 10
623559M	59	78.0	50.0	52	100	1410	1 / 10
623560M	60	80.0	50.0	53	100	1471	1 / 10
623563M	63	83.0	55.0	53	100	1511	1 / 6
623565M	65	85.0	58.0	55	100	1613	1 / 6
623570M	70	92.0	58.0	55	100	1766	1 / 6

Bit Socket

6023

3/4"

- For torx internal screw
 - DIN 3120
 - E.g. on commercial vehicles and agricultural machinery
 - Screw of the steering tie lever on commercial vehicles MAN
- 602380 : for M series
6023A0 : for F series



KT NO.	Size	L mm		
602360	T60	80	246	2/48
602370	T70	80	253	2/48
602380	T80	80	326	2/48
602390	T90	80	332	2/48
6023A0	T100	80	339	2/48

6025

3/4"

- HEXAGON head
- DIN 7422



KT NO.	mm	L mm		
602514	H14	80	257	2 / 48
602517	H17	80	268	2 / 48
602519	H19	80	278	2 / 48
602522	H22	80	361	2 / 48

Ratchet

6724

3/4"

- Reversible ratchet
- 8° gear action degree (45 teeth)
- DIN 3122



KT NO.	Overall length inch	mm		
6724-20F	20	500	2223	1 / 6
6724DK	renewal kits	-	-	-

6778

3/4"

- Quick release reversible ratchet
- 15° gear action degree (24 teeth)
- DIN 3122



KT NO.	Overall length inch	mm		
6778-20FS	20	500	2612	1 / 6
6778DK	renewal kits	-	-	-

Ratchet & Accessory

6779

3/4"

- Reversible ratchet
- 15° gear action degree (24 teeth)
- DIN 3122



KT NO.	Overall length inch	mm		
6779-20F	20	500	2449	1 / 6
6779DK	renewal kits	-	-	-

6251

3/4"

- Extension bar
- DIN 3123



KT NO.	Overall length inch	mm		
6251-04	4	100	418	4 / 40
6251-08	8	200	734	2 / 20
6251-16	16	400	1375	1 / 10

6452

3/4"

- Flexible handle
- Action degree -180°
- DIN 3122

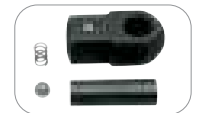

KT NO.	Overall length inch	mm		
6452-18F	18	450	1768	1 / 10
6452-30F	30	750	2581	1 / 8
6452DK	renewal kits	-	-	-

- Material - chrome vanadium alloy steel
- Finishing - polished, chrome plated & black phosphate sunk

6462

3/4"

- Flexible Handle
- Action degree-180
- DIN3122



KT NO.	Overall length inch	mm		
6462-40P	40	1020	3900	1 / 6
6462DK	renewal kits	-	-	-

Ratchet & Accessory

6482

3/4"

- 180° swivel ratchet head
- 3 position ratchet control : forward / reverse / lock
- Telescopic handle : 620 mm-970 mm
- 15° gear action (24 teeth)
- DIN 3122

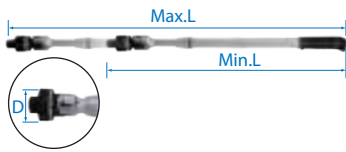
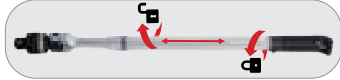
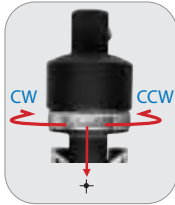

6482DK

KT NO.	D mm	Min.L inch	Min.L mm	Max.L inch	Max.L mm	⚖️	📦
6482-24G	46	24	620	36	970	3	1 / 6
6482DK							renewal kits

6572

3/4"

- Sliding T-handle
- DIN 3122



6572DK



KT NO.	Overall length inch	Overall length mm	⚖️	📦
6572-20	20	500	1542	1 / 10
6572DK		renewal kits	-	-

6581

3/4"

- 90° L-handle



KT NO.	Overall length inch	Overall length mm	⚖️	📦
6581-12	12	300	1307	10
6581-18	18	450	1939	12

6585

3/4"

- Double driver L-handle 90°



KT NO.	Overall length inch	Overall length mm	⚖️	📦
6585-19	19	478	2010	12

6791

KT No. & D1 3/4"

- Universal joint
- DIN 3123, ISO 3316



KT NO.	Overall length inch	Overall length mm	⚖️	📦
6791	4-1/4	108	571	2 / 20

6814

6818

3/4"

- Adapter
- Convert to 1/2" drive or 1" drive
- 6814→Max. torque : 512 N·m
- DIN 3123, ISO 3316



6814 / 6818

KT NO.	Spec.	⚖️	📦
6814	3/4"F x 1/2"M	120	8 / 96
6818	3/4"F x 1"M	296	6 / 60

Socket Rail

8760807D1

3/4"

- Socket rail carrier with retaining clip
- 446mm roller cabinet



KT NO.	Square drive	Clip	L (mm)
8760807D1	3/4"	7	508
8760	🔧		

Socket Set

6014MR

Metal case size (mm) :
537 x 177 x 78 (0.26 cuft)



6014MR

6314MR

3/4"

14
PC.



6314MR

KT NO.

Contents

13.8 1

6014MR	6330M	22, 24, 27, 30, 32, 36, 38, 41, 46, 50	6779-20F	6251-08 6251-16	6572-20
6314MR	6335M				

6016MR

Metal case size (mm) :
537 x 177 x 78 (0.26 cuft)

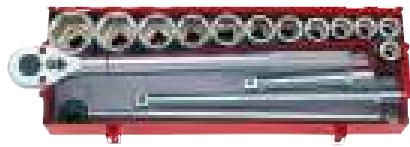

6016MR

6316MR

6016SR

3/4"

16
PC.

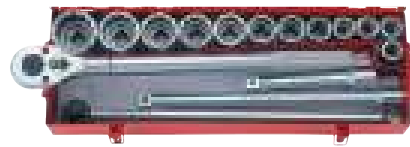

6016MR/6016SR

KT NO.

Contents

14.0 1

6016MR	6330M	21, 22, 23, 24, 27, 30, 32, 36, 38, 41, 46, 50	6779-20F	6251-08 6251-16	
6316MR	6335M				
6016SR	6330S	7/8, 15/16, 1, 1-1/16, 1-1/8, 1-1/4, 1-3/8, 1-1/2, 1-5/8, 1-3/4, 1-7/8, 2	6572-20		

6023MR

Metal case size (mm) :
537 x 177 x 78 (0.26 cuft)



6023MR

6323MR

6023SR

3/4"

23
PC.



6023MR/6023SR

KT NO.

Contents

17.1 1

6023MR	6330M	21, 22, 23, 24, 26, 27, 28, 29, 30, 32, 34, 35, 36, 38, 41, 46, 50	6779-20F	6251-04 6251-08 6251-16	
6323MR	6335M				
6023SR	6330S	7/8, 15/16, 1, 1-1/16, 1-1/8, 1-3/16, 1-1/4, 1-5/16, 1-3/8, 1-7/16, 1-1/2, 1-9/16, 1-5/8, 1-3/4 1-13/16, 1-7/8, 2	6572-20	6791	

6224CR

Metal case size (mm) :
537 x 177 x 78 (0.26 cuft)



24
PC.

KT NO.

Contents

17.9 1

6224CR	6330M	22, 24, 27, 30, 32, 36, 38, 41, 46, 50	6779-20F	6251-08 6251-16	6572-20
	6330S	1, 1-1/8, 1-1/4, 1-5/16, 1-3/8, 1-7/16, 1-1/2, 1-5/8, 1-3/4, 2			

Socket Set

6226CR

3/4"

Metal case size (mm) :
537 x 177 x 78 (0.26 cuft)



26
PC.

KT NO.	Contents		17.2	1
6226CR	6330M	22, 24, 27, 30, 32, 36, 38, 41, 46, 50	6251-04 6251-08	6572-20
	6330S	7/8, 15/16, 1, 1-1/8, 1-3/16, 1-5/16, 1-3/8, 1-7/16, 1-5/8, 1-3/4, 1-7/8, 2		6452-18F

6014MR12

Blow case size(mm) :
422 x 372 x 92 (0.51 cuft)



Contents	10.8	1 / 2
6330M	22, 24, 27, 30, 32, 36, 38, 41, 46, 50	
6251-04 6251-08	6779-20F	
6572-20		

6314MR12

Blow case size(mm) :
422 x 372 x 92 (0.51 cuft)



14
PC.

Contents	10.8	1 / 2
6335M	22, 24, 27, 30, 32, 36, 38, 41, 46, 50	
6251-04 6251-08	6779-20F	
6572-20		



Socket Set

8330M

1"

- DIN 3124, ISO 2725-1

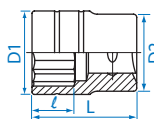

KT NO.	mm	D1 mm	D2 mm	l mm	L mm	Scale	Box
833036M	36	52	48	26	65	514	1 / 24
833038M	38	54	48	26	65	536	1 / 24
833041M	41	58	50	29	70	659	1 / 24
833046M	46	65	54	32	75	961	1 / 24
833050M	50	70	54	34	75	985	1 / 20
833054M	54	74	57	38	80	1164	1 / 20
833055M	55	76	57	42	83	1256	1 / 12
833058M	58	79	57	42	83	1263	1 / 12
833060M	60	82	58	46	87	1488	1 / 12
833063M	63	86	58	46	87	1548	1 / 12
833065M	65	88	65	49	90	1817	1 / 12
833067M	67	91	70	49	91	1932	1 / 12
833070M	70	94	70	50	93	2064	1 / 8
833071M	71	95	70	50	93	2026	1 / 8
833075M	75	100	70	50	95	2168	1 / 8
833077M	77	103	80	52	100	2732	1 / 8
833080M	80	107	80	52	100	3009	1 / 8

8330S

1"

- ANSI / ASME B107.1

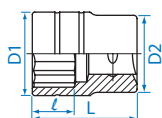

KT NO.	inch	D1 mm	D2 mm	l mm	L mm	Scale	Box
833046S	1-7/16	52	48	26	65	506	1 / 24
833048S	1-1/2	54	48	26	65	537	1 / 24
833054S	1-11/16	60	54	29	70	741	1 / 24
833060S	1-7/8	67	54	34	75	912	1 / 10
833064S	2	71	54	34	75	989	1 / 10
833072S	2-1/4	78	57	42	83	1267	1 / 12
833076S	2-3/8	82	58	46	87	1452	1 / 12
833084S	2-5/8	90	65	49	90	1825	1 / 12
833094S	2-15/16	100	70	52	95	2076	1 / 8
8330A0S	3-1/8	107	80	52	100	2975	1 / 8

Ratchet

8779

1"

- Reversible ratchet
- 15° gear action degree (24 teeth)
- DIN 3122



8779DK



KT NO.	Overall length inch	mm	Scale	Box
8779-32F	32	800	4400	5
8779DK	renewal kits	-	-	-

Accessory

- Chrome vanadium handle, chrome molybdenum driver
- Chrome plated handle & black phosphate sunk driver

8251

1"

- Extension bar
- DIN3123



KT NO.	Overall length		Scale	Box
	inch	mm		
8251-08	8	200	1364	1 / 16
8251-16	16	400	2555	1 / 10

8462

1"

- Flexible Handle
- Action degree-180
- DIN3122



8462DK



KT NO.	Overall length		Scale	Box
	inch	mm		
8462-40P	40	1020	3950	1 / 6
8462DK	renewal kits	-	-	-

8572

1"

- Sliding T-handle
- DIN 3122



8572DK



KT NO.	Overall length		Scale	Box
	inch	mm		
8572-25	25	630	4200	6
8572DK	renewal kits	-	-	-

8581

1"

- L-handle
- DIN 3122



KT NO.	Overall length		Scale	Box
	inch	mm		
8581-26	26	660	5182	4

8816

1"

- Adapter
- Convert to 3/4" drive
- Max. torque : 1412 N·m
- DIN 3123, ISO 3316



3/4" drive(M)

← 1" drive(F)

KT NO.	Spec.	Scale	Box
8816	1" F x 3/4" M	309	6 / 48

Socket Set

8015MR

Metal case size (mm) :
660 x 205 x 108 (0.52 cuft)

8015SR

1"



14
PC.

KT NO.	Contents		Kg 34.1	1
8015MR	8330M	36, 41, 46, 50, 55, 60, 65, 70, 75, 80	8779-32F 8251-08 8251-16 8572-25	
8015SR	8330S	1-7/16, 1-1/2, 1-11/16, 1-7/8, 2, 2-1/4, 2-3/8, 2-5/8, 2-15/16, 3-1/8		

Socket Rail Set

7112PR

- Socket rail 260mmL
- Rail with 5 PC. 3/8" & 6 PC. 1/2" drive clip

12
PC.

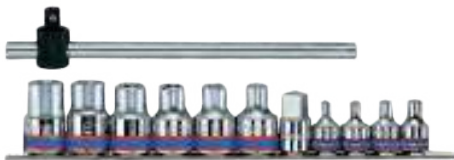

Contents 0.76 2 / 24

3375M	E4, E5, E6, E8
4375M	E10, E12, E14, E16, E18, E20
3571-08	8771011 3814

7113PR

3/8"+1/2"

- Socket rail 260mmL
- Rail with 6 PC. 3/8" drive & 6 PC. 1/2" drive clip

12
PC.



Contents 0.6 2 / 24

3375M	E4, E5, E6, E7, E8, E11
4375M	E10, E12, E14, E16, E18, E20
8771012	

Socket Set

7120PR

Metal case size (mm) :
296 x 130 x 41 (0.056 cuft)

7120PR01

3/8"+1/2"

KT NO.	Contents		Kg 1.79	1 / 10
7120PR	4023	T30, T40, T45, T50, T55	3375M E6, E7, E8, E10 4375M E12, E14, E16, E18, E20	
7120PR01	4027	T30H, T40H, T45H, T50H, T55H		
			3023 T10, T15, T20, T25, T27 4813	



20
PC.

Socket Set

5022MR

Metal case size (mm) :
285 x 135 x 45 (0.059 cuft)

5522MR

5022SR

1/4"+3/8"

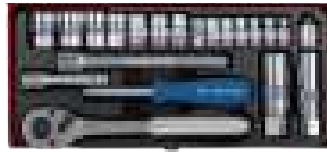

5022MR / 5522MR

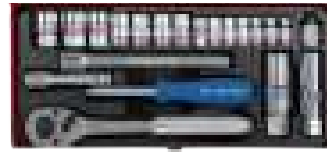

5022SR

21
PC.

KT NO.	Contents		1.60 kg	1 / 10
5022MR	3330M	10, 11, 12, 13, 14, 17, 19	2335M	363021
5522MR	3335M		4, 5, 5.5, 6, 7, 8, 9	363521
5022SR	2335S	5/32, 3/16, 7/32, 1/4, 9/32, 5/16, 11/32	363021	363516
	3330S	3/8, 7/16, 15/32, 1/2, 9/16, 11/16, 3/4		3812
				3769-08F
				3221-03
				2179DF

5039CR

Metal case size (mm) :
318 x 147 x 46 (0.076 cuft)

1/4"+3/8"

Contents		2.60 kg	1 / 10
2335M	4.5, 5, 6, 7, 8, 9, 10, 11, 12		
2335S	3/16, 7/32, 1/4, 9/32, 5/16, 11/32, 3/8, 7/16, 1/2		
3330M	9, 10, 11, 12, 13, 14, 16, 17, 19		
3330S	3/8, 7/16, 1/2, 9/16, 5/8, 11/16, 3/4		
3769-08F	3221-03	2179DF	363021
			3812

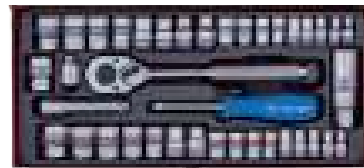

39
PC.

7558MR

Metal case size (mm) :
445 x 187 x 50 (0.147 cuft)

1/4"+1/2"

Contents		3.8 kg	1 / 4
2335M	4, 4.5, 5, 5.5, 6, 7, 8, 9, 10, 11, 12, 13, 14		
4335MR	8, 10, 11, 12, 13, 14, 15, 16, 17, 18, 19, 21, 22, 24		
1025S	4, 6, 8		
1025P	PH1, PH2, PH3		
1025H	H3, H4, H5, H6, H7, H8		
1025U	T10H, T15H, T20H, T25H, T27H, T30H, T40H		
1025Z	PZ1, PZ2, PZ3		
2779-55G	4779-10GR	2792	4791R
2221-02	4251-05R	2179DF	2141
2221-04			

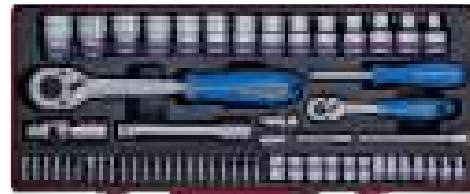

58
PC.

Socket Set

9063MR

9063MR01

9563MR

9563MR01

1/4"+3/8"+1/2"

Metal case size (mm) :
476 x 282 x 57 (0.27 cuft)



9063MR/9563MR



9063MR01/9563MR01

62
PC.

KT NO.	Contents		Kg 7.4	1/2	
9063MR	4330MR	3330M	363021	4768-10F 3769-08F	2335M 4, 4.5, 5, 6, 7, 8, 9, 10, 11, 12 3023 T20, T25, T27, T30, T40 3025 H4, H5, H6, H8, H10
	3330M				
9563MR	4335MR	4330MR / 4335MR 12, 13, 14, 15, 16, 17, 18, 19, 20, 21, 22, 23, 24, 27, 30, 32	363521	3235M 12, 14, 17, 19	2571-45 2221-04 3571-08 3221-06 4572-12 4251-06R
	3335M				
9063MR01	4330MR	3330M / 3335M 8, 9, 10, 11, 12, 13, 14, 15, 17, 19	363021	4755-10G 3779-08G	3792 4791R 3812
	3330M				
9563MR01	4335MR	3335M	363521	3235M 10, 13, 17, 19	
	3335M				

9033CR

1/4"+3/8"+1/2"

Metal case size (mm) :
450 x 370 x 56 (0.329 cuft)

Contents	Kg 12.3	1/2
2335M 4, 4.5, 5, 5.5, 6, 7, 8, 9, 10, 11, 12, 13		
2335S 5/32, 3/16, 7/32, 1/4, 9/32, 5/16, 11/32, 3/8, 7/16, 1/2		
2235M 4, 4.5, 5, 5.5, 6, 7, 8, 9, 10, 11, 12, 13		
2235S 5/32, 3/16, 7/32, 1/4, 9/32, 5/16, 11/32, 3/8, 7/16, 1/2		
3330M 8, 9, 10, 11, 12, 13, 14, 15, 16, 17, 18, 19, 20, 21, 22		
4330MR 8, 9, 10, 11, 12, 13, 14, 15, 16, 17, 18, 19, 20, 21, 22, 23, 24, 25, 26, 27, 28, 30, 32		
4330SR 3/8, 7/16, 1/2, 9/16, 5/8, 11/16, 3/4, 13/16, 7/8, 15/16, 1, 1-1/8, 1-3/16, 1-1/4		
2015MX H3, H4, H5, H6, H8, H10		
2015SX 1/8, 3/16, 7/32, 1/4, 5/16, 3/8		
2011X PH1, PH2, PH3, PH4		
1115-03 H1.5, H2, H2.5		



135
PC.

Contents					
463516RC	463021RC	2179DF	2452-05F		
3769-08F	4768-10F	2571-45	4572-10		
2221-02	3221-03	4251-05R	3812	3792	4791R
2221-04	3221-06	4251-10R			
2561	3840	4840			

cross bar. 4-1/2"L 3/8" drive spin disc. 1/2" drive spin disc.

Socket & Tool Set

7096MR

7596MR

1/4"+1/2"

Blow case size (mm) :
422 x 275 x 85 (0.35 cuft)

96
PC.



KT NO.	Contents		Kg 6.22	1 / 4
7096MR	2330M	4, 4.5, 5, 5.5, 6, 7, 8, 9, 10, 11, 12, 13, 14	2031	2771-55G
	2230M	6, 7, 8, 9, 10, 11, 12, 13	2032	2178DF
	4230M	14, 15, 17, 19, 22	2033	4771-10GR
	4330MR	10, 11, 12, 13, 14, 15, 16, 17, 18, 19, 20, 21, 22, 24, 27, 30, 32	2035	2571-45
	4630RC	16, 21	2038	4222-10 2221-02 2221-04 4251-05R
7596MR	2335M	4, 4.5, 5, 5.5, 6, 7, 8, 9, 10, 11, 12, 13, 14	1836P	2792 4791R
	2235M	6, 7, 8, 9, 10, 11, 12, 13	1836S	3824
	4235M	14, 15, 17, 19, 22	1836T	414810S
	4335MR	10, 11, 12, 13, 14, 15, 16, 17, 18, 19, 20, 21, 22, 24, 27, 30, 32	1836H	7702-25
	4635RC	16, 21	1836Z	2745
		1115-03	1.5, 2, 2.5	

Socket & Tool Set

7011MR

Blow case size (mm) :
422 x 275 x 85 (0.35 cuft)

7511MR

1/4"+1/2"

110
PC.



7011MR



7511MR

HAND SOCKET & ACCESSORIES

KT NO.

Contents

kg 6.90 1 / 4

7011MR	2330M 4, 4.5, 5, 5.5, 6, 7, 8, 9, 10, 11, 12, 13, 14	2375M E4, E5, E6, E7, E8	1115-03 1.5, 2, 2.5
	2230M 6, 7, 8, 9, 10, 11, 12, 13	4375M E10, E11, E12, E14, E16, E18, E20, E24	2771-55G
	4230M 14, 15, 17, 19, 22	2031 PH1, PH2	4771-10GR
	4330MR 10, 11, 12, 13, 14, 15, 16, 17, 18, 19, 20, 21, 22, 24, 27, 30, 32	2032 4, 5.5, 6.5	2178DF
	463016RC 463021RC	2033 T8, T10, T15, T20, T25, T27, T30	4222-10
	2035 H3, H4, H5, H6	4251-05R	
7511MR	2335M 4, 4.5, 5, 5.5, 6, 7, 8, 9, 10, 11, 12, 13, 14	2038 PZ1, PZ2	2571-45
	2235M 6, 7, 8, 9, 10, 11, 12, 13	1836P PH3, PH4	3824
	4235M 14, 15, 17, 19, 22	1836S 8x1.2, 10x1.6, 12x2.0	414810S
	4335MR 10, 11, 12, 13, 14, 15, 16, 17, 18, 19, 20, 21, 22, 24, 27, 30, 32	1836T T40, T45, T50, T55, T60	2792
	463516RC 463521RC	1836H H7, H8, H10, H12, H14	4791R
		1836Z PZ3, PZ4	2745
		7702-25	

Socket & Tool Set

7082MR

























Blow case size (mm) :
422 x 275 x 85 (0.35 cuft)

7582MR

1/4"+1/2"

83
PC.



KT NO.	Contents		5.65 kg	1/4"
7082MR	 2330M	4, 4.5, 5, 5.5, 6, 7, 8, 9, 10, 11, 12, 13, 14	 1060	8, 10, 11, 12, 13, 14, 17, 19
	 4330MR	14, 15, 16, 17, 18, 19, 20, 22, 24, 27, 30, 32	 PH1, PH2 2031	
	 463016RC	 463021RC	 4, 5.5, 6.5 2032	 T8, T10, T15, T20, T25, T27, T30 2033
7582MR	 2335M	4, 4.5, 5, 5.5, 6, 7, 8, 9, 10, 11, 12, 13, 14	 H3, H4, H5, H6 2035	 T40, T45, T50, T55 1836T
	 4335MR	14, 15, 16, 17, 18, 19, 20, 22, 24, 27, 30, 32	 PZ1, PZ2 2038	 PZ3, PZ4 1836Z
	 463516RC	 463521RC	 PH3, PH4 1836P	 2771-55G
			 8x1.2, 10x1.6, 12x2.0 1836S	 4771-10GR
			 H8, H10, H12, H14 1836H	 2178DF
				
				

Socket Set

7077MR

7577MR

1/4"+1/2"

Blow case size (mm) :
422 x 360 x 110 (0.59 Cuft)

77
PC.



KT NO.	Contents		kg 7.52	1/2
7077MR	2330M 4, 5, 6, 7, 8, 9, 10, 11, 12	463016RC	1.5, 2, 2.5 1115-03	2771-55G
	2230M 8, 10, 12, 13		PH1, PH2, PH3 1025P	4771-10GR
	4330MR 12, 13, 14, 15, 17, 18, 19, 21, 22, 24, 27, 30, 32	463021RC	3, 4, 5, 6 1025S	6111-07
7577MR	2335M 4, 5, 6, 7, 8, 9, 10, 11, 12	463516RC	H3, H4, H5, H6 1025H	6516-10
	2235M 8, 10, 12, 13		T10, T15, T20, T25, T27, T30, T40 1025T	2178DF
	4335MR 12, 13, 14, 15, 17, 18, 19, 21, 22, 24, 27, 30, 32	463521RC	PH1 x 80, PH2 x 100, PH3 x 150 1421	7821-50
		4 x 100, 6.5 x 100 1422	2571-45	2221-03
		8, 10, 12, 13, 14, 15, 17, 19 1060	2312-06	2312-06
			4222-10	4222-10
			4251-05R	4251-05R
			2792	2792
			4791R	4791R
			3824	3824
			2141	2141

Socket & Tool Set

7081MR

7581MR

7581MR01

1/4"+1/2"

Blow case size (mm) :
422 x 360 x 110 (0.59 cuft)



HAND SOCKET & ACCESSORIES

81
PC.



7581MR01



7581MR / 7081MR

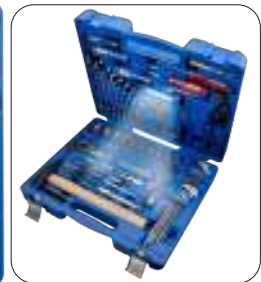

KT NO.

Contents

7.14 1/2

7081MR	2330M 4, 4.5, 5, 5.5, 6, 7, 8, 9, 10, 11, 12, 13 4330MR 10, 11, 12, 13, 14, 15, 17, 19, 22, 24	4771-10GR	463016RC 463021RC	1421 PH1 x 80, PH2 x 100 1422 4 x 100, 5.5 x 125, 6.5 x 150 1025H H3, H4, H5, H6, H7, H8 1025T T20, T25, T30, T40 1120MR H1.5, H2, H2.5, H3, H4, H5, H6, H8, H10 1147R T10H, T15H, T20H, T25H, T27H, T30H, T40H 1060 6, 7, 8, 10, 12, 13, 14, 15, 17, 19 276A-04G 6111-06 6311-06 6516-10 76104-05 76215-05 76404-06 2221-04 9DC22 79831 7821-50 4251-05R 750-60 2792 4791R
7581MR	2335M 4, 4.5, 5, 5.5, 6, 7, 8, 9, 10, 11, 12, 13	4771-10GR	463516RC	
7581MR01	4335MR 10, 11, 12, 13, 14, 15, 17, 19, 22, 24	4755-10G	463521RC	

Socket & Tool Set

7087MR

7587MR01

Blow case size (mm) :
422 x 360 x 110 (0.59 cuft)

7587MR

7587SR

1/4"+1/2"



7087MR / 7587MR



7587MR01



7587SR

87
PC.

KT NO.

Contents

9.2 1/2

7087MR	<ul style="list-style-type: none"> 5, 5.5, 6, 7, 8, 10, 11, 12, 13 2330M 7, 8, 10, 12, 13 2230M 10, 12, 13, 14, 15, 17, 18, 19, 21, 22, 24, 27, 30, 32 4330MR 8, 10, 12, 13, 14, 15, 17, 18, 19, 22 1060 	<ul style="list-style-type: none"> 20107MR01 2312-06 463016RC 	<ul style="list-style-type: none"> H5, H6, H7, H8, H10, H12 1636H M6, M8, M10, M12 1636M T30, T40, T45, T50, T55, T60 1636T
7587MR	<ul style="list-style-type: none"> 5, 5.5, 6, 7, 8, 10, 11, 12, 13 2335M 7, 8, 10, 12, 13 2235M 10, 12, 13, 14, 15, 17, 18, 19, 21, 22, 24, 27, 30, 32 4335MR 8, 10, 12, 13, 14, 15, 17, 18, 19, 22 1060 	<ul style="list-style-type: none"> 20107MR01 2312-06 	<ul style="list-style-type: none"> PH1 x 80, PH2 x 100 1421 4 x 100, 5.5 x 100 1422
7587MR01	<ul style="list-style-type: none"> 5, 5.5, 6, 7, 8, 10, 11, 12, 13 2335S 7, 8, 10, 12, 13 2235S 10, 12, 13, 14, 15, 17, 18, 19, 21, 22, 24, 27, 30, 32 4335SR 8, 10, 12, 13, 14, 15, 17, 18, 19, 22 1060 	<ul style="list-style-type: none"> 20107MR01 2221-06 	<ul style="list-style-type: none"> 463014RC 414810M 4791R 2792 4251-05R 2571-45 4453-15FR
7587SR	<ul style="list-style-type: none"> 5/32, 3/16, 1/4, 9/32, 5/16, 11/32, 3/8, 7/16, 1/2 2335S 9/32, 5/16, 3/8, 7/16, 1/2 2235S 3/8, 7/16, 1/2, 9/16, 5/8, 11/16, 3/4, 25/32, 13/16, 7/8, 15/16, 1-1/16, 1-1/8, 1-1/4 4335SR 1/4, 5/16, 3/8, 7/16, 1/2, 9/16, 11/16, 3/4, 13/16, 7/8 5060 	<ul style="list-style-type: none"> 20107SR 2312-06 463516RC 	<ul style="list-style-type: none"> 2779-55G 4779-10GR 6111-06 6231-07 6516-10 20407PR 19980016 19980410

Socket & Tool Set

7098MR

7598MR

1/4"+1/2"

Blow case size (mm) :
422 x 360 x 110 (0.59 cuft)



97
PC.



HAND SOCKET & ACCESSORIES

KT NO.	Contents		Weight 8.87	Box 1/2
7098MR	2330M	4, 4.5, 5, 5.5, 6, 7, 8, 9, 10, 11, 12, 13	1421	4771-10BR
	2230M	7, 8, 10, 12, 13	1422	2771-55F
	4330MR	10, 12, 13, 14, 15, 16, 17, 18, 19, 21, 22, 24, 27, 30, 32	1462	2571-45
	463016RC		1025S	4573-10
	463021RC		1025P	4121-11GR
7598MR	2335M	4, 4.5, 5, 5.5, 6, 7, 8, 9, 10, 11, 12, 13	1025H	6111-06
	2235M	7, 8, 10, 12, 13	1025U	6516-10
	4335MR	10, 12, 13, 14, 15, 16, 17, 18, 19, 21, 22, 24, 27, 30, 32	1025Z	2178DF
	463516RC		1060	4583-12R
	463521RC		4251-10R	2221-02
			2221-04	2792
			4223-02R	4791R
			2141	

Socket & Tool Set

7003MR

7503MR















































1/4"+1/2"

Blow case size (mm) :
422 x 360 x 110 (0.59 Cuft)

103
PC.



HAND SOCKET & ACCESSORIES

KT NO.	Contents		kg 9.24	1/2
7003MR	  4, 4.5, 5, 5.5, 6, 7, 8, 9, 10 2330M	  E4, E5, E6, E7, E8, E10 2375M	 4771-10GR  2771-55G  6111-07  2178DF  3611-08R  2221-03  2221-06  2571-45  4572-10	 1 / 2
	  8, 9, 10, 11, 12, 13, 14, 15, 16, 17, 18, 19, 20, 21, 22, 23, 24, 27, 30, 32 4330MR	  E11, E12, E14, E16, E18 4375M		
	  463016RC   463021RC	 8, 10, 11, 12, 13, 14, 15, 16, 17, 18, 19, 21, 22, 24 1060  8 x 10, 11 x 13, 12 x 14, 17 x 19 1930		
7503MR	  4, 4.5, 5, 5.5, 6, 7, 8, 9, 10 2335M	  H2, H2.5, H3, H4, H5, H6, H7, H8, H10 1025H	 2312-06  4251-05R  4251-10R  2792  4791R  4223-02R  2128-26  2141	 1 / 2
	  8, 9, 10, 11, 12, 13, 14, 15, 16, 17, 18, 19, 20, 21, 22, 23, 24, 27, 30, 32 4335MR	  T15, T20, T25, T27, T30, T40, T45, T50 1025T		
	  463516RC   463521RC	 PH1 x 80, PH2 x 100 1421  5.5 x 125, 6.5 x 150 1422		

Socket & Tool Set

7010MR

7510MR

1/4"+1/2"

Blow case size (mm) :
422 x 360 x 110 (0.59 cuft)



7010MR



7510MR

110
PC.



KT NO.	Contents		9.2	1/2
7010MR	8, 10, 12, 13 2230M	PH0, PH1, PH2, PH3 1025P	1.5, 2, 2.5, 3, 4, 5, 6, 8, 10 1145MR	
	5, 5.5, 6, 7, 8, 10, 12, 13, 14 2330M	H2.5, H3, H4, H5, H6 1025H	8, 10, 12, 13, 14, 15, 17, 18, 19 1060	
	14, 17, 19, 22 4230M	3, 4, 5, 6.5 1025S	4771-10GR	276A-04G
	8, 10, 12, 13, 14, 15, 17, 18, 19, 22, 24, 27, 30 4330MR	T15, T20, T25, T27, T30 1025T	2178DF	6111-06 6211-06
	463014RC	PZ1, PZ2 1025Z	6516-10	79831
7510MR	8, 10, 12, 13 2235M	H5, H6, H7, H8, H10, H12 1636H	4452-15FR	2452-05F
	5, 5.5, 6, 7, 8, 10, 12, 13, 14 2335M	M6, M8, M10, M12 1636M	4251-05R	2221-04
	14, 17, 19, 22 4235M	T30, T40, T45, T50, T55, T60 1636T	9DC22	7821-50
	8, 10, 12, 13, 14, 15, 17, 18, 19, 22, 24, 27, 30 4335MR	No.1 x 80, No.2 x 100, No.2 x 38 1421	4791R	2792 414810M
	463514RC	5.5 x 100, 6.5 x 150, 6.5 x 38 1422	2141	

Socket & Tool Set

7028MR

7528MR

7528MR01

1/4"+1/2"

Blow case size (mm) :
560 x 400 x 110 (0.87 Cuft)

128
PC.



7028MR



7528MR



7528MR01

HAND SOCKET & ACCESSORIES

KT NO.

Contents

14.95

1 / 2

KT NO.	Contents	14.95	1 / 2	
7028MR	4, 4.5, 5, 5.5, 6, 7, 8, 9, 10, 11, 12, 13 2330M	6, 7, 8, 9, 10, 11, 12, 13, 14, 15, 16, 17, 19, 21, 22, 24, 27, 30, 32 1060		
	7, 8, 10, 12, 13 2230M	8 x 10, 9 x 11, 12 x 13, 14 x 17, 17 x 19 1930		
	10, 12, 13, 14, 15, 17, 19 4230M	2755-55G	1143 T10, T15, T20, T25, T27, T30, T40	
	8, 9, 10, 11, 12, 13, 14, 15, 16, 17, 18, 19, 21, 22, 24, 27, 30, 32 4330MR	4755-10G	1145 H1.5, H2, H2.5, H3, H4, H5, H6, H8, H10	
	463016RC 463021RC		1421 PH1 x 80, PH2 x 38, PH2 x 100	
7528MR	4, 4.5, 5, 5.5, 6, 7, 8, 9, 10, 11, 12, 13 2335M	2755-55G	1422 5 x 75, 6.5 x 38, 6.5 x 100	
	7, 8, 10, 12, 13 2235M	4755-10G	2033 T10, T15, T20, T25, T27	
	10, 12, 13, 14, 15, 17, 19 4235M		2035 H4, H5, H6, H7, H8, H10	2311-06
	8, 9, 10, 11, 12, 13, 14, 15, 16, 17, 18, 19, 21, 22, 24, 27, 30, 32 4335MR	2771-55G	4025 H12, H14, H17	2293-02 2293-06
	463516RC 463521RC	4771-10GR	7821-50	2221-03 2221-06
7528MR01		6111-07	4251-05R 4251-10R	
		6211-06	76215-05	
		6511-10C	76404-06	
		4452-15FR	76505-05	
		2571-45	76104-05	
	4572-10	76303-05	2128-26	
		4223-02R	2792 4791R	

Socket & Tool Set

7053MR01

Blow case size (mm) :
560 x 400 x 110 (0.87 cuft)

7553MR01

1/4"+1/2"



7053MR01



7553MR01

153
PC.



HAND SOCKET & ACCESSORIES

KT NO.	Contents		Kg 14.17	1/2
7053MR01	2330M	4, 4.5, 5, 5.5, 6, 7, 8, 9, 10, 11, 12, 13	2375M	E4, E5, E6, E7, E8
	4330MR	10, 11, 12, 13, 14, 15, 16, 17, 18, 19, 20, 21, 22, 23, 24, 25, 26, 27, 28, 29, 30, 32	4375M	E10, E12, E14, E16, E18, E20
	2230M	6, 7, 8, 9, 10, 11, 12, 13	1461	PH1 x 75, PH2 x 100
	4230M	13, 14, 17, 19, 22	1462	5.5 x 100, 6.5 x 150
7553MR01	2335M	4, 4.5, 5, 5.5, 6, 7, 8, 9, 10, 11, 12, 13	1421	PH2 x 38
	4335MR	10, 11, 12, 13, 14, 15, 16, 17, 18, 19, 20, 21, 22, 23, 24, 25, 26, 27, 28, 29, 30, 32	1422	6.5 x 38
	2235M	6, 7, 8, 9, 10, 11, 12, 13	1025S	4, 5, 6.5
	4235M	13, 14, 17, 19, 22	1025P	PH0, PH1, PH2
			1025H	H3, H4, H5, H6
			1025Z	PZ1, PZ2, PZ3
			1025T	T10, T15, T20, T25, T27, T30, T40
			1636H	H5, H6, H7, H8, H10, H12
			1636M	M6, M8, M10, M12
			1636T	T30, T40, T45, T50, T55, T60
			1680H	H5, H6, H7, H8, H10, H12
			1680M	M6, M8, M10, M12
		1680T	T25, T30, T40, T45, T50, T55	
		463014RC		
		463016RC		
	8, 10, 11, 12, 13, 14, 15, 16, 17, 18, 19, 21, 22, 24, 27	1060		
	8x10, 11x13, 12x14	1930		
		4771-10GR		
		2771-55G		
		6511-10		
		6111-06		
		6211-06		
		2178DF		
		4462-18FR		
		2452-05F		
		2221-02		
		2221-06		
		4251-05R		
		4251-10R		
		2792		
		4791R		
		4223-02R		
		2142		
		414810M		

Socket & Wrench Set

9043MR

9543MR

1/4"+3/8"+1/2"

Blow case size (mm) :
560 x 400 x 110 (0.87 cuft)

143
PC.



9043MR



9543MR



HAND SOCKET & ACCESSORIES

KT NO.

Contents

13.7 1/2

<p>9043MR</p> <ul style="list-style-type: none"> 4, 4.5, 5, 5.5, 6, 7, 8, 9, 10 2330M 6, 7, 8, 9, 10, 11, 12, 13, 14, 15, 17, 18, 19, 21, 22 3330M 8, 10, 12, 13, 14, 15, 16, 17, 18, 19, 20, 21, 22, 23, 24, 25, 27, 30, 32 4330MR 16, 21 4630RC 	<ul style="list-style-type: none"> E4, E5, E6, E7, E8 2375M E10, E12, E14, E16, E20 4375M PH0, PH1, PH2, PH3 1025P 4, 5.5, 7 1025S T10H, T15H, T20H, T25H, T27H, T30H, T40H 1025U H2, H3, H4, H5, H6, H7, H8, H10 1025H PZ0, PZ1, PZ2, PZ3 1025Z 	<ul style="list-style-type: none"> H1.5, H2.0, H2.5, H3.0, H4.0, H5.0, H6.0, H8.0, H10 1145MR 4771-10GR 2771-55G 2178DF 6111-07 3781-11F 4452-18FR 4581-10 6011-10R 4222-10 2312-06 2221-02 2221-04 2221-06 3221-03 3221-06 4251-03R 3824 3812 2141 2792 3792 4791R 7821-30 79093-03M 79831
<p>9543MR</p> <ul style="list-style-type: none"> 4, 4.5, 5, 5.5, 6, 7, 8, 9, 10 2335M 6, 7, 8, 9, 10, 11, 12, 13, 14, 15, 17, 18, 19, 21, 22 3330M 8, 10, 12, 13, 14, 15, 16, 17, 18, 19, 20, 21, 22, 23, 24, 25, 27, 30, 32 4335MR 16, 21 4635RC 	<ul style="list-style-type: none"> PH2 x 38, PH1 x 80 1421 PH2 x 100 1461 6.5 x 38, 5.5 x 75 1422 6.5 x 150 1462 6, 7, 8, 9, 10, 11, 12, 13, 14, 15, 16, 17, 18, 19, 21, 22, 24 1060 8 x 10, 10 x 12, 11 x 13, 12 x 14, 17 x 19 1930 	<ul style="list-style-type: none"> 2771-55G 2178DF 6111-07 3781-11F 4452-18FR 4581-10 6011-10R 4222-10 2312-06 2221-02 2221-04 2221-06 3221-03 3221-06 4251-03R 3824 3812 2141 2792 3792 4791R 7821-30 79093-03M 79831

Socket & Wrench Set

9519MR50 1/4"+3/8"+1/2"

Blow case size (mm) :
560 x 400 x 110 (0.87 cuft)

119
PC.



Contents	
	2335M 4, 4.5, 5, 5.5, 6, 7, 8, 9, 10, 11, 12, 13
	3335M 9, 10, 11, 12, 13, 14, 15, 16, 17, 18, 19
	4335MR 20, 21, 22, 24, 27, 30, 32
	2235M 4, 4.5, 5, 5.5, 6, 7, 8
	3235M 10, 11, 12, 13, 14, 15
	3375M E8, E10, E11, E12, E14, E16, E18
	2031 PH1, PH2, PH3
	2032 5.5, 6.5
	2035 H3, H4, H6, H8, H10
	3023 T10, T15, T20, T25, T27, T30, T40, T45, T50

Contents		12.48	1 / 2
	4535M	17, 19, 21	
	4435M	10, 12, 13, 14, 17, 19	
	1060	8, 9, 10, 11, 12, 13, 14, 15, 16, 17, 18, 19	
	36A014	366516	2178DF 4453-15F
	2293-02	3293-03	4293-05 2792 3792 4791R
	2293-04	3293-06	4293-10
	6516-10C	6111-06	6211-06 6311-08
	2771-55G	3771-08G	4771-10GR 20219MR

HAND SOCKET & ACCESSORIES

Tool Box Set

112
PC.



9052-002MRV

Plastic case size (mm) :
456 x 372 x 155 (0.93 cuft)



HAND SOCKET & ACCESSORIES



Pouch 1

13
PC.



Pouch 2

7
PC.



EVA foam(9-7592MPV)

92
PC.



Pouch 1

Contents

	1062	8, 9, 10, 11, 12, 13, 14, 16, 17, 18, 19, 22
	9TA281	

Pouch 2

Contents

3611-10R	6AB31-75	6211-06	6111-07
6311-08	6511-10	79095-05M	

EVA foam(9-7592MPV)

Contents



10.46 KG CUFT 1.16

	2335MR	4, 4.5, 5, 5.5, 6, 7, 8, 9, 10, 11, 12, 13, 14
	4335MR	10, 13, 15, 16, 17, 18, 19, 20, 21, 22, 24, 27, 30, 32
	1147PR	T10H, T15H, T20H, T25H, T27H, T30H, T40H, T45H, T50H
	1120MR	H1.5, H2, H2.5, H3, H4, H5, H6, H8, H10
	20002UB	5 x 6mm, 8 x 10mm
	1032CQ	
	1005APR	
	2792	
	4791R	
	4251-10R	
	2179DF	
	7821-30	
	4773-10GS	
	2755-55G	
	2142	

Tools Bag Set

92543MR

92543MR01 1/4"

Tool bag size (mm) :
250 x 400 x 30 (0.11 cuft)



43
PC.

92543MR

92543MR01

KT NO.	Contents		Weight	Quantity
92543MR	79093-03C	2335M 4, 5, 6, 7, 8, 9, 10, 11, 12, 13, 14	2.49	1 / 10
	7978-07	1421 PH0 x 60, PH1 x 100, PH2 x 38, PH2 x 150		
	2141	1422 3.0 x 75, 6.5 x 38, 6.5 x 150		
92543MR01	79093-03M	1025Z PZ1, PZ2, PZ3	2.49	1 / 10
	7971-07	1025T T10, T15, T20, T25, T27, T30, T40		
	2142			

Axial Lock Nut Socket

44K9M 1/2"

64K9M 3/4"

▪ Specially for SKF bearing

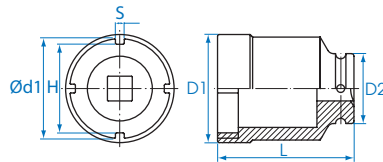

KT NO.	Designation	mm	DR.	H mm	S mm	D1 mm	D2 mm	Ød1 mm	L mm	Weight	Quantity
44K928M	TMFS 3	28	1/2	24.4	3.8	36	30	30	90	382	1 / 24
44K932M	TMFS 4	32	1/2	28.4	3.8	38	30	34	90	378	1 / 24
44K938M	TMFS 5	38	1/2	34.4	4.8	46	30	40	90	559	1 / 24
64K975M	TMFS 11	75	3/4	69.4	6.8	83.5	54	77	105	1645	1 / 6

External & Internal KM Locknut Socket

44K7 1/2"

64K7 3/4"

44K8 1/2"

64K8 3/4"

- Specially for SKF bearing

KT NO.	Designation	mm	DR.	H mm	S mm	D1 mm	D2 mm	Ød1 mm	L mm		
44K732M	TMFS 4	32	1/2	28.3	3.7	37.3	30	28.3	60	207	1 / 24
44K738M	TMFS 5	38	1/2	34.3	4.7	44.3	30	34.3	60	259	1 / 24
44K745M	TMFS 6	45	1/2	41.3	4.7	52.3	30	41.3	60	321	1 / 24
44K752M	TMFS 7	52	1/2	48.3	4.7	59.3	30	48.3	60	350	1 / 20
44K758M	TMFS 8	58	1/2	53.5	4.7	65.5	30	53.5	60	422	1 / 20
64K765M	TMFS 9	65	3/4	60.5	5.7	73.5	42	60.5	68	601	1 / 20
64K770M	TMFS 10	70	3/4	65.5	5.7	78.5	42	65.5	68	625	1 / 12
64K775M	TMFS 11	75	3/4	69.5	6.7	82.6	42	59.5	68	664	1 / 12
64K780M	TMFS 12	80	3/4	74.5	6.7	87.7	42	74.5	68	691	1 / 12

KT NO.	Designation	mm	DR.	H mm	S mm	D1 mm	D2 mm	Ød1 mm	L mm		
44K832M	TMFS 4	32	1/2	28.3	3.7	41.5	30	34.5	60	282	1 / 24
44K838M	TMFS 5	38	1/2	34.3	4.7	49.5	30	40.7	60	365	1 / 24
44K845M	TMFS 6	45	1/2	41.3	4.7	59.0	30	48.0	60	474	1 / 24
44K852M	TMFS 7	52	1/2	48.3	4.7	66.0	30	54.8	60	540	1 / 20
44K858M	TMFS 8	58	1/2	53.5	5.7	73.0	30	60.8	60	582	1 / 20
64K865M	TMFS 9	65	3/4	60.5	5.7	80.0	42	67.7	68	915	1 / 20
64K870M	TMFS 10	70	3/4	65.5	5.7	86.0	42	72.7	68	1022	1 / 12
64K875M	TMFS 11	75	3/4	69.5	6.7	93.0	42	78.8	68	1167	1 / 12
64K880M	TMFS 12	80	3/4	74.5	6.7	98.0	42	83.5	68	1329	1 / 12



44K7 & 64K7

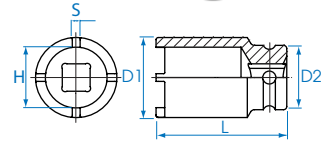

44K8 & 64K8

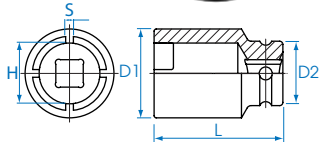

Application: Removal and installation of bearings, gear wheels, cone roll bearings, ball bearings etc.
Trucks, land and construction machines, municipally and forestry technology etc.

Internal KM Locknut Socket Set

7K09MP

1/2"+3/4"

- For loosening and tightening groove nuts DIN 981 on crimping or clamping sleeves
- Minimum space on nut size
- Use in conjunction with extensions, ratchets etc.
- Working range KM4 to KM12 (nuts of ball bearing)

Contents		7.90		1 / 3
44K8	TMFS 4, 5, 6, 7, 8			
64K8	TMFS 9, 10, 11, 12			



9 PC.

External KM Locknut Socket Set

7K09MP01

1/2"+3/4"

- For loosening and tightening groove nuts DIN 981 on crimping or clamping sleeves
- Minimum space on nut size
- Slim design
- Working range KM4 to KM12 (nuts of ball bearing)

Contents		5.33		1 / 3
44K7	TMFS 4, 5, 6, 7, 8			
64K7	TMFS 9, 10, 11, 12			



9 PC.





IMPACT SOCKETS & ACCESSORIES

Professional production & quality control



KING TONY impact socket 50% higher torque on performance.

Quality control also ensure that a sufficient level of production output. King Tony uses advance technology to inspect tiny difference on each step. Our Impact socket reach 50% higher torque than DIN standards.

Standard Impact Socket & Rail Set

2535M

1/4"

- DIN 3129, ISO 2725-2

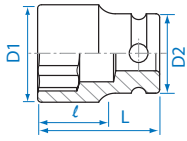

KT NO.	mm	D1 mm	D2 mm	l mm	L mm	g	kg	kg
253504M	4	7.5	13	4	23	12	20	600
253545M	4.5	8.1	13	5	23	12	20	600
253505M	5	8.8	13	6	23	11	20	600
253555M	5.5	9.4	13	6	23	12	20	600
253506M	6	10.0	13	7	23	13	20	600
253507M	7	11.3	13	7	23	13	20	600
253510M	10	15.0	13	9	23	17	12	360
253513M	13	18.8	13	9	23	22	12	360
253514M	14	19.8	13	9	23	23	10	300

Standard Impact Socket

3535M

3/8"

- DIN 3129, ISO 2725-2

3535S

3/8"

- ANSI / ASME B107.2

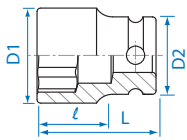

KT NO.	mm	D1 mm	D2 mm	l mm	L mm	g	kg	kg
353506M	6	10.6	19	5	32	33	12	360
353507M	7	11.8	19	5	32	33	12	360
353508M	8	13.2	19	6	32	35	12	360
353509M	9	14.5	19	6	32	36	12	360
353510M	10	15.5	19	7	32	37	12	360
353511M	11	17.0	19	7	32	39	12	360
353512M	12	18.2	19	8	32	39	12	360
353513M	13	19.4	22	9	32	53	10	200
353514M	14	20.7	22	9	32	54	10	200
353515M	15	22.0	22	10	32	56	10	200
353516M	16	23.8	22	10	32	57	10	200
353517M	17	24.8	22	11	32	58	10	200
353518M	18	25.8	22	11	32	62	10	200
353519M	19	27.6	22	13	32	63	10	160

KT NO.	inch	D1 mm	D2 mm	l mm	L mm	g	kg	kg
353508S	1/4	10.8	19	5	32	32	12	360
353510S	5/16	13.0	19	6	32	36	12	360
353512S	3/8	15.3	19	7	32	38	12	360
353514S	7/16	17.0	19	7	32	38	12	360
353516S	1/2	18.2	19	9	32	53	12	360
353518S	9/16	20.7	22	9	32	53	10	200
353520S	5/8	23.8	22	10	32	57	10	200
353522S	11/16	24.5	22	11	32	60	10	200
353524S	3/4	27.0	22	11	32	61	10	160

Impact Accessory

2863P

1/4"

- Adapter
- Convert to 3/8" drive
- DIN 3121



KT NO.	Spec.	D mm	g	kg
2863P	1/4"F x 3/8"M	14	20	12 / 360

Deep Impact Socket

3435M

3/8"

- DIN 3121

3435S

3/8"

- ANSI / ASME B107.2

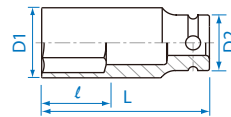

KT NO.	mm	D1 mm	D2 mm	l mm	L mm	g	kg	kg
343506M	6	10.6	19	10	65	50	6	120
343507M	7	11.8	19	10	65	55	6	120
343508M	8	13.2	19	12	65	68	6	120
343509M	9	14.5	19	12	65	65	6	120
343510M	10	15.5	19	12	65	82	6	120
343511M	11	17.0	19	13	65	75	6	120
343512M	12	18.2	19	14	65	89	6	120
343513M	13	19.4	22	14	65	111	6	120
343514M	14	20.7	22	14	65	109	6	120
343515M	15	22.0	22	16	65	112	6	120
343516M	16	23.8	22	16	65	126	6	96
343517M	17	24.8	22	17	65	143	6	96
343518M	18	25.8	22	18	65	133	6	96
343519M	19	27.6	22	20	65	171	6	96
343520M	20	28.3	22	20	65	154	6	96
343521M	21	29.5	22	22	65	161	6	96
343522M	22	30.8	22	22	65	178	5	60
343523M	23	32.0	22	24	65	177	5	60
343524M	24	32.5	22	24	65	176	5	60



KT NO.	inch	D1 mm	D2 mm	l mm	L mm	g	kg	kg
343508S	1/4	10.8	19	10	63.5	62	6	120
343510S	5/16	13.0	19	12	63.5	71	6	120
343512S	3/8	15.3	19	12	63.5	82	6	120
343514S	7/16	17.0	19	13	63.5	84	6	120
343516S	1/2	18.2	19	14	63.5	113	6	120
343518S	9/16	20.7	22	14	65	114	6	120
343520S	5/8	23.8	22	16	65	126	6	96
343522S	11/16	24.5	22	17	65	138	6	96
343524S	3/4	27.0	22	20	65	154	6	96
343526S	13/16	29.5	22	22	65	156	6	96
343528S	7/8	30.8	22	22	65	172	5	60

Impact Star Socket

3575M

 3/8"

- For torx external screw
- DIN 3121

KT NO.	Size	D1 mm	D2 mm	ℓ mm	L mm		
357505M	E5	9.6	19	4.0	32	31	12 / 360
357506M	E6	10.2	19	5.0	32	31	12 / 360
357507M	E7	10.8	19	6.0	32	33	12 / 360
357508M	E8	11.5	19	6.5	32	35	12 / 360
357510M	E10	12.0	19	7.0	32	33	12 / 360
357512M	E12	14.0	19	9.0	32	34	12 / 360
357514M	E14	17.0	19	9.5	32	40	12 / 360

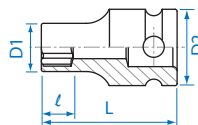

Impact Bit Socket

KT No. & D1





- Air pressure must not exceed 90PSI (6.3bar)
- Adjust your air tool to its lowest torque output, should this torque level not be enough, increase it gradually

3051

 3/8"

- For phillips head screw
- DIN 3121





KT NO.	⊕ No.	L mm		
305101	PH1	55	33	12 / 360
305102	PH2	55	35	12 / 360
305103	PH3	55	40	12 / 360
305104	PH4	55	45	12 / 360

3052

 3/8"

- For slotted head screw
- DIN 3121





KT NO.	Tip width mm	L mm		
305255	5.5	55	32	12 / 360
305208	8	55	39	12 / 360
305210	10	55	45	12 / 360

3055M

 3/8"

- For hexagon head screw
- DIN 3121





KT NO.	mm	L mm	Max. torq N-m		
305504M	H4	55	20.8	34	12 / 360
305505M	H5	55	36.0	38	12 / 360
305506M	H6	55	62.4	40	12 / 360
305507M	H7	55	97.0	43	12 / 360
305508M	H8	55	144.0	46	12 / 360
305510M	H10	55	264.0	55	12 / 360
305512M	H12	55	480.0	65	12 / 360
305514M	H14	55	650.0	77	12 / 288
305516M	H16	55	680.0	91	12 / 288
305517M	H17	55	715.0	99	12 / 288

3055S

 3/8"

- For hexagon head
- DIN 3121





KT NO.	inch	L mm	Max. torq N-m		
305504S	1/8	55	18.8	34	12 / 360
305545S	9/64	55	20.8	34	12 / 360
305505S	5/32	55	22.5	36	12 / 360
305506S	3/16	55	36.0	36	12 / 360
305507S	7/32	55	62.4	38	12 / 360
305508S	1/4	55	93.6	41	12 / 360
305510S	5/16	55	144.0	46	12 / 360
305512S	3/8	55	264.0	54	12 / 360
305516S	1/2	55	518.0	71	12 / 360

3065M

 3/8"

- For hexagon head screw
- DIN 3121



KT NO.	mm	L mm	Max. torq N-m		
306504M	H4	90	20.8	39	8 / 160
306505M	H5	90	36.0	44	8 / 160
306506M	H6	90	62.4	50	8 / 160
306508M	H8	90	144.0	66	8 / 160
306510M	H10	90	264.0	86	8 / 160



Impact Bit Socket

KT No. & D1

3053

3063

3/8"

- For torx internal screw
- DIN 3121



KT NO.	Size	L mm	g	Box
305310	T10	55	35	12 / 360
305315	T15	55	34	12 / 360
305320	T20	55	35	12 / 360
305325	T25	55	36	12 / 360
305327	T27	55	36	12 / 360
305330	T30	55	36	12 / 360
305340	T40	55	39	12 / 360
305345	T45	55	43	12 / 360
305350	T50	55	44	12 / 360
305355	T55	55	52	12 / 288
305360	T60	55	60	12 / 288
306320	T20	90	42	8 / 160
306325	T25	90	42	8 / 160
306327	T27	90	43	8 / 160
306330	T30	90	45	8 / 160
306340	T40	90	50	8 / 160
306345	T45	90	57	8 / 160
306350	T50	90	64	8 / 160
306355	T55	90	82	8 / 160

Impact Accessory

3862P

3/8"

- Adapter
- Convert to 1/4" drive
- 3862P → Max. torque : 62 N·m
- DIN 3121



KT NO.	Spec.	D mm	g	Box
3862P	3/8" F x 1/4" M	20.8	32	24 / 384

3864P

3/8"

- Adapter
- Convert to 1/2" drive
- DIN 3121



KT NO.	Spec.	D mm	g	Box
3864P	3/8" F x 1/2" M	20.8	53	24 / 384

Impact Accessory

3147

3/8"

- Bit holder



KT NO.	Size	L mm	g	Box
314708S	1/4"	40	41	12 / 420
314710S	5/16"	40	43	12 / 420
314710M	10mm	40	42	12 / 420

3260P

3/8"

- Extension bar
- DIN 3121



KT NO.	Overall length inch	Overall length mm	g	Box
3260-03P	3	75	98	6 / 120
3260-04P	4	100	121	8 / 160
3260-05P	5	125	147	8 / 144
3260-06P	6	150	169	5 / 100
3260-08P	8	200	217	6 / 72
3260-10P	10	250	264	6 / 54

3796P

3/8"

- Universal joint
- DIN 3121

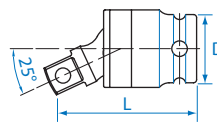

KT NO.	Overall length inch	Overall length mm	D mm	g	Box
3796P	2	50	22	87	10 / 200

90608

90609

3/8"

- Locking pin
- Chrome vanadium steel
- DIN 3129



KT NO. Desp. ϕ d / l Applied to socket sizes

90608	pin	2.5	14	3535M (6~12 mm)	3535S (1/4~1/2 inch)
				3435M (6~12 mm)	3435S (1/4~1/2 inch)
				3055M (4~12 mm)	3055S (3/16~1/2 inch)
				3065M (4~10 mm)	3053 (T10~T15)
				3575M (E5~E14)	
3053.3055.3065.3147.3862.3864					

90609	pin	2.5	16	3535M (13~19 mm)	3535S (9/16~3/4 inch)
				3435M (13~24 mm)	3435S (9/16~7/8 inch)
				3260.3796	

Impact Bit Socket Set

3406MP

3/8"

- For hexagon head screw
- 55mmL

Metal case size (mm) :
203 x 79 x 41 (0.023 cuft)

6
PC.



Contents 0.72 1 / 20

3055M H4, H5, H6, H8, H10, H12

3419PP

3/8"

- For torx internal head
- 55mmL

Metal case size (mm) :
203 x 79 x 41 (0.023 cuft)

9
PC.



Contents 0.62 1 / 20

3053 T10, T15, T20, T25, T27, T30, T40, T45, T50



Standard Impact Socket

KT No. & D1



4530M

1/2"

- DIN 3129, ISO 2725-2

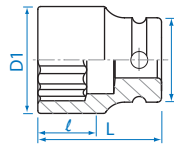

KT NO.	mm	D1 mm	D2 mm	l mm	L mm		
453008M	8	15.0	25	7	38	65	10 / 200
453009M	9	16.3	25	7	38	68	10 / 200
453010M	10	17.6	25	8	38	68	10 / 200
453011M	11	18.8	25	8	38	69	10 / 200
453012M	12	20.0	25	9	38	73	10 / 200
453013M	13	21.2	25	10	38	71	10 / 200
453014M	14	22.5	25	10	38	78	10 / 200
453015M	15	23.8	30	11	38	111	10 / 160
453016M	16	25.0	30	11	38	118	10 / 160
453017M	17	26.2	30	12	38	116	10 / 160
453018M	18	27.5	30	13	38	115	10 / 160
453019M	19	28.8	30	13	38	114	10 / 160
453020M	20	29.5	30	13	38	117	10 / 160
453021M	21	30.0	30	14	40	121	8 / 160
453022M	22	32.4	30	14	40	129	8 / 160
453023M	23	33.2	30	15	40	130	8 / 160
453024M	24	34.4	30	15	42	147	6 / 120
453025M	25	36.0	30	15	42	164	6 / 120
453026M	26	37.0	30	15	42	168	6 / 120
453027M	27	38.0	30	16	44	170	6 / 120
453028M	28	41.0	30	16	44	205	6 / 120
453029M	29	41.0	30	17	44	184	6 / 120
453030M	30	42.0	30.5	17	44	197	6 / 120
453032M	32	46.0	30	19	44	226	6 / 120
453033M	33	46.0	30	19	46	246	6 / 96
453034M	34	46.0	30	20	46	217	6 / 96
453036M	36	47.0	30	20	46	214	6 / 96
453038M	38	50.0	30	21	50	279	6 / 60
453041M	41	56.0	30	22	52	402	6 / 60

4530S

1/2"

- ANSI / ASME B107.2

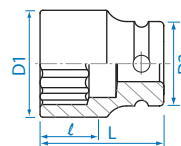

KT NO.	inch	D1 mm	D2 mm	l mm	L mm		
453016S	1/2	20	25	10	38	72	10 / 200
453018S	9/16	22	25	10	38	76	10 / 200
453020S	5/8	24	25	11	38	78	10 / 200
453022S	11/16	26	30	12	38	116	10 / 160
453024S	3/4	28.8	30	13	38	120	10 / 160
453026S	13/16	30	30	14	40	122	8 / 160
453028S	7/8	32	30	14	40	138	8 / 160
453030S	15/16	34	30	15	42	148	6 / 120
453032S	1	36	30	15	42	162	6 / 120
453034S	1-1/16	38	30	16	44	167	6 / 120
453036S	1-1/8	41	30	17	44	189	6 / 120
453038S	1-3/16	42	30.5	17	44	203	6 / 120

Stubby Impact Socket

4525M

1/2"

- For impact wrench use
- DIN 3129, ISO 2725-2

19, 22, 24 mm

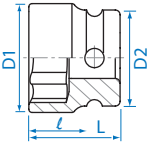

KT NO.	mm	D1 mm	D2 mm	ℓ mm	L mm	g	kg
452513M	13	20	26	5.5	28.5	57	10 / 160
452514M	14	22	26	5.5	28.5	61	10 / 160
452517M	17	26	26	5.5	28.5	64	10 / 160
452519M	19	28	26	10	28.5	63	10 / 160
452521M	21	30	30	10	28.5	81	8 / 160
452522M	22	32	30	10	28.5	87	8 / 160
452524M	24	34	30	10	28.5	80	6 / 120

Standard Impact Socket

4535M

1/2"

- DIN 3129, ISO 2725-2

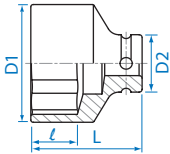

KT NO.	mm	D1 mm	D2 mm	ℓ mm	L mm	g	kg
453508M	8	15.0	25	7	38	67	10 / 200
453509M	9	16.3	25	7	38	69	10 / 200
453510M	10	17.6	25	8	38	70	10 / 200
453511M	11	18.8	25	8	38	71	10 / 200
453512M	12	20.0	25	9	38	73	10 / 200
453513M	13	21.2	25	10	38	75	10 / 200
453514M	14	22.5	25	10	38	78	10 / 200
453515M	15	23.8	30	11	38	117	10 / 160
453516M	16	25.0	30	11	38	118	10 / 160
453517M	17	26.2	30	12	38	121	10 / 160
453518M	18	27.5	30	13	38	123	10 / 160
453519M	19	28.8	30	13	38	117	10 / 160
453520M	20	29.5	30	13	38	115	10 / 160
453521M	21	30.0	30	14	40	118	8 / 160
453522M	22	31.8	30	14	40	132	8 / 160
453523M	23	33.8	30	15	40	144	8 / 160
453524M	24	33.8	30	15	42	139	6 / 120
453525M	25	35.8	30	15	42	156	6 / 120
453526M	26	37.8	30	15	42	173	6 / 120
453527M	27	37.8	30	16	44	175	6 / 120
453528M	28	39.8	30	16	44	204	6 / 120
453529M	29	39.8	30	17	44	198	6 / 120
453530M	30	41.8	30.5	17	44	206	6 / 120
453532M	32	46.0	30	19	44	239	6 / 120
453533M	33	46.0	30	19	46	246	6 / 96
453534M	34	46.0	30	20	46	240	6 / 96
453535M	35	46.0	30	20	46	227	6 / 96
453536M	36	47.0	30	20	46	243	6 / 96
453537M	37	49.0	30	21	48	271	6 / 60

KT NO.	mm	D1 mm	D2 mm	ℓ mm	L mm	g	kg
453538M	38	50.0	30	21	50	291	6 / 60
453539M	39	51.0	30	22	50	306	6 / 60
453541M	41	56.0	30	22	52	403	6 / 60
453546M	46	64.0	30	23	55	595	4 / 32

4535S

1/2"

- ANSI / ASME B107.2

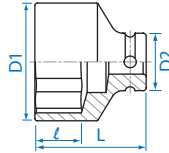

KT NO.	inch	D1 mm	D2 mm	ℓ mm	L mm	g	kg
453510S	5/16	15	25	7	38	66	10 / 200
453512S	3/8	17	25	7	38	70	10 / 200
453514S	7/16	18	25	8	38	70	10 / 200
453516S	1/2	20	25	10	38	72	10 / 200
453518S	9/16	22	25	10	38	77	10 / 200
453520S	5/8	24	25	11	38	80	10 / 160
453522S	11/16	26	30	12	38	116	10 / 160
453524S	3/4	28.8	30	13	38	116	10 / 160
453526S	13/16	30	30	14	40	127	8 / 160
453528S	7/8	32	30	14	40	136	8 / 160
453530S	15/16	34	30	15	42	152	6 / 120
453532S	1	36	30	15	42	164	6 / 120
453534S	1-1/16	38	30	16	44	180	6 / 120
453536S	1-1/8	41	30	17	44	199	6 / 120
453538S	1-3/16	42	30.5	17	44	208	6 / 120
453540S	1-1/4	46	30	18	44	237	6 / 120

Impact Socket Set

4472MP

4472SP 1/2"

- Standard impact socket
- Stand size (mm) : 415 x 336 x 320



4472MP / 4472SP

KT NO.	PC.	Contents	Each Q'ty	
4472MP	158		8, 9, 10, 11, 12, 13, 14	8
			15, 16, 17, 18, 19, 20, 21	6
			22, 23, 24	7
			25, 26, 27, 28	6
			29, 30, 32	5
4472SP	106		5/16, 3/8, 7/16, 1/2, 9/16	8
			5/8, 11/16, 3/4, 13/16	6
			7/8, 15/16,	7
			1, 1-1/16, 1-1/8	6
			1-3/16, 1-1/4	5

KT NO.	Spec.	kg	Cuft
4472MP-A	87103	6.37	0.67
4472MP-D	158 PC. socket content	19.63	0.54
4472SP-A	87103	6.37	0.67
4472SP-D	106 PC. socket content	20.4	0.37

Deep Impact Socket

KT No. & D1



4430M

1/2"

▪ DIN 3121

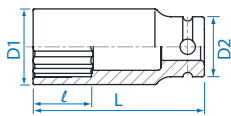

KT NO.	mm	D1 mm	D2 mm	l mm	L mm	g	kg
443008M	8	15.0	24.8	12	78	125	6 / 120
443009M	9	16.3	24.8	12	78	135	6 / 120
443010M	10	17.6	24.8	12	80	153	6 / 120
443011M	11	18.8	24.8	13	80	150	6 / 120
443012M	12	20.0	24.8	14	80	166	6 / 120
443013M	13	21.2	24.8	14	80	158	6 / 120
443014M	14	22.5	24.8	14	80	172	6 / 120
443015M	15	23.8	29.8	16	80	233	6 / 96
443016M	16	25.0	29.8	16	80	232	6 / 96
443017M	17	26.2	29.8	16	80	240	6 / 96
443018M	18	27.5	29.8	17	80	253	6 / 96
443019M	19	28.8	29.8	18	80	272	6 / 96
443020M	20	29.5	29.8	20	80	253	6 / 96
443021M	21	29.8	29.8	20	80	254	6 / 96
443022M	22	32.4	30.0	22	80	296	5 / 60
443023M	23	33.2	30.0	24	80	291	5 / 60
443024M	24	34.4	30.0	24	80	299	5 / 60
443027M	27	38.0	30.0	27	80	343	5 / 60
443030M	30	42.0	30.5	30	80	397	5 / 50
443032M	32	46.0	30.0	32	80	454	1 / 24
443036M	36	47.0	30.0	36	80	422	1 / 24

4430S

1/2"

▪ ANSI / ASME B107.2

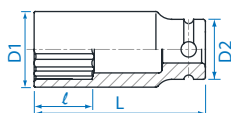

KT NO.	inch	D1 mm	D2 mm	l mm	L mm	g	kg
443020S	5/8	24.0	24.8	16	80	179	6 / 96
443024S	3/4	28.8	29.8	18	80	258	6 / 96
443028S	7/8	32.0	30.0	22	80	284	5 / 60
443030S	15/16	34.0	30.0	24	80	297	5 / 60
443032S	1	36.0	30.0	24	80	328	5 / 60
443034S	1-1/16	38.0	30.0	27	80	340	5 / 60
443036S	1-1/8	41.0	30.0	27	80	394	5 / 50
443040S	1-1/4	46.0	30.0	32	80	477	1 / 24
443042S	1-5/16	46.0	30.0	34	80	440	1 / 24
443048S	1-1/2	50.0	30.0	34	80	454	1 / 24

4435M

1/2"

▪ DIN 3121

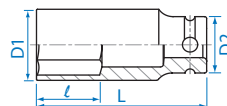

KT NO.	mm	D1 mm	D2 mm	l mm	L mm	g	kg
443508M	8	15.0	24.8	12	78	124	6 / 120
443509M	9	16.3	24.8	12	78	137	6 / 120
443510M	10	17.6	24.8	12	80	149	6 / 120
443511M	11	18.8	24.8	13	80	153	6 / 120
443512M	12	20.0	24.8	14	80	164	6 / 120
443513M	13	21.2	24.8	14	80	169	6 / 120
443514M	14	22.5	24.8	14	80	168	6 / 120
443515M	15	23.8	29.8	16	80	225	6 / 96
443516M	16	25.0	29.8	16	80	233	6 / 96
443517M	17	26.2	29.8	16	80	239	6 / 96
443518M	18	27.5	29.8	17	80	246	6 / 96
443519M	19	28.8	29.8	18	80	254	6 / 96
443520M	20	29.0	29.8	20	80	244	6 / 96
443521M	21	29.8	29.8	20	80	247	6 / 96
443522M	22	31.8	30.0	22	80	278	5 / 60
443523M	23	33.8	30.0	24	80	316	5 / 60
443524M	24	33.8	30.0	24	80	297	5 / 60
443525M	25	35.8	30.0	24	80	326	5 / 60
443526M	26	37.8	30.0	27	80	367	5 / 60
443527M	27	37.8	30.0	27	80	364	5 / 60
443528M	28	39.8	30.0	27	80	424	5 / 50
443529M	29	39.8	30.0	27	80	407	5 / 50
443530M	30	41.8	30.5	30	80	422	5 / 50
443532M	32	46.0	30.0	32	80	503	1 / 24
443533M	33	46.0	30.0	32	80	471	1 / 24
443534M	34	46.0	30.0	33	80	466	1 / 24
443536M	36	47.0	30.0	36	80	445	1 / 24
443538M	38	50.0	30.0	38	80	515	1 / 24
443541M	41	56.0	30.0	38	80	689	1 / 24
443546M	46	64.0	30.0	40	80	943	1 / 24

4435S

1/2"

▪ ANSI / ASME B107.2

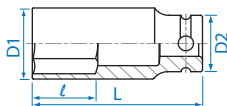

KT NO.	inch	D1 mm	D2 mm	l mm	L mm	g	kg
443510S	5/16	14.0	24.8	12	78	123	6 / 120
443512S	3/8	17.0	24.8	12	80	151	6 / 120
443514S	7/16	18.0	24.8	13	80	151	6 / 120
443516S	1/2	20.0	24.8	14	80	157	6 / 120
443518S	9/16	22.0	24.8	14	80	175	6 / 120
443520S	5/8	24.0	24.8	16	80	182	6 / 96
443522S	11/16	26.0	29.8	17	80	247	6 / 96
443524S	3/4	28.8	29.8	18	80	254	6 / 96
443526S	13/16	29.8	29.8	20	80	263	6 / 96
443528S	7/8	32.0	30.0	22	80	294	5 / 60
443530S	15/16	34.0	30.0	24	80	308	5 / 60
443532S	1	36.0	30.0	24	80	337	5 / 60



KT NO.	inch	D1 mm	D2 mm	ℓ mm	L mm		
443534S	1-1/16	38.0	30.0	27	80	364	5 / 60
443536S	1-1/8	41.0	30.0	27	80	407	5 / 50
443538S	1-3/16	42.0	30.5	30	80	418	5 / 50
443540S	1-1/4	46.0	30.0	32	80	499	1 / 24
443542S	1-5/16	46.0	30.0	34	80	471	1 / 24

Impact Socket Set

4466MP **4466SP** **1/2"**

- Deep impact socket
- Stand size (mm) :
415 x 336 x 320



4466MP / 4466SP

KT NO.	PC.	Contents	Each Q'ty	
4466MP	166	4435M	8, 9, 10, 11, 12, 13, 14	8
			15, 16, 17, 18, 19, 20	7
			21, 22, 23, 24	7
			25, 26, 27, 28, 29	6
			30, 32	5
4466SP	110	4435S	5/16, 3/8, 7/16,	8
			1/2, 9/16	8
			5/8, 11/16, 3/4,	7
			13/16, 7/8, 15/16	7
			1, 1-1/16, 1-1/8	6
			1-3/16, 1-1/4	5

Packing NO.	Spec.		Cuff
4466MP-A	87103	5.87	0.54
4466MP-DA	166 PC. socket content	21.63	0.44
4466MP-DB		23.40	0.37
4466SP-A	87103	6.37	0.67
4466SP-D	110 PC. socket content	28.0	0.47

Impact Thin Wall Socket

4835M **1/2"**

- DIN 3121

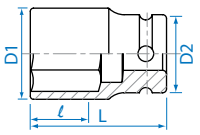

KT NO.	mm	D1 mm	D2 mm	ℓ mm	L mm		
483510M	10	16	25.0	20	52	93	10 / 180
483511M	11	17	25.0	20	52	88	10 / 180
483512M	12	18	25.0	20	52	92	10 / 180
483513M	13	19	25.0	20	52	95	10 / 180
483514M	14	21	25.0	20	52	99	10 / 180
483516M	16	23	25.0	20	52	101	8 / 80
483517M	17	25	25.0	23	52	106	8 / 80
483519M	19	27	30.0	23	52	150	8 / 80
483521M	21	29	30.0	25	52	142	8 / 80
483522M	22	31	30.0	25	52	158	8 / 80
483523M	23	32	30.0	26	52	172	8 / 80
483524M	24	33	30.0	26	52	165	8 / 80
483526M	26	36	30.0	27	65	241	6 / 60
483527M	27	37	30.0	27	65	249	6 / 60
483530M	30	41	30.5	27	65	294	5 / 50
483535M	35	46	30.0	32	70	367	1 / 24

4930M **1/2"**

- DIN 3121

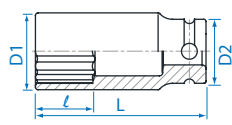

KT NO.	mm	D1 mm	D2 mm	ℓ mm	L mm		
493008M	8	13.2	25	12	78	118	6 / 120
493009M	9	14.0	25	12	78	118	6 / 120
493010M	10	15.5	25	12	80	134	6 / 120
493011M	11	16.7	25	13	80	136	6 / 120
493012M	12	18.0	25	14	80	142	6 / 120
493013M	13	19.0	25	14	80	165	6 / 120
493014M	14	20.5	25	14	80	153	6 / 120
493015M	15	21.5	30	16	80	204	6 / 96
493016M	16	23.0	30	16	80	219	6 / 96
493017M	17	24.5	30	16	80	218	6 / 96
493018M	18	25.5	30	17	80	267	6 / 96
493019M	19	27.0	30	18	80	241	6 / 96
493020M	20	28.0	30	20	80	235	6 / 96
493021M	21	29.0	30	20	80	241	6 / 96
493022M	22	30.5	30	22	80	252	5 / 60
493023M	23	32.0	30	24	80	267	5 / 60
493024M	24	33.0	30	24	80	277	5 / 60
493027M	27	37.0	30	27	80	318	5 / 60
493030M	30	40.5	30	30	80	355	5 / 50
493032M	32	42.5	30	32	80	356	5 / 50
493036M	36	45.5	30	36	80	361	1 / 24

4935M **1/2"**

- DIN 3121

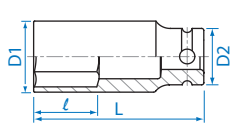

KT NO.	mm	D1 mm	D2 mm	ℓ mm	L mm		
493510M	10	15.5	25	12	80	133	6 / 120
493511M	11	16.7	25	13	80	134	6 / 120
493512M	12	18.0	25	14	80	140	6 / 120
493513M	13	19.0	25	14	80	142	6 / 120
493514M	14	20.5	25	14	80	142	6 / 120

KT NO.	mm	D1 mm	D2 mm	ℓ mm	L mm		
493516M	16	23.0	30	16	80	201	6 / 96
493517M	17	24.5	30	16	80	211	6 / 96
493519M	19	27.0	30	18	80	222	6 / 96
493521M	21	29.0	30	20	80	230	6 / 96
493522M	22	30.5	30	22	80	261	5 / 60
493523M	23	32.0	30	24	80	273	5 / 60
493524M	24	33.0	30	24	80	285	5 / 60
493526M	26	35.5	30	27	80	303	5 / 60
493527M	27	37.0	30	27	80	335	5 / 60
493530M	30	40.5	30	30	80	376	5 / 50

Impact Thin Wall Socket

4935S 1/2"

- ANSI / ASME B107.2

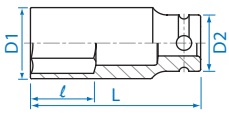

KT NO.	inch	D1 mm	D2 mm	ℓ mm	L mm		
493510S	5/16	13.0	25.0	12	80	129	6 / 120
493512S	3/8	16.0	25.0	12	80	144	6 / 120
493514S	7/16	16.7	25.0	13	80	148	6 / 120
493516S	1/2	19.0	25.0	14	80	159	6 / 120
493518S	9/16	20.5	25.0	14	80	165	6 / 120
493520S	5/8	23.0	25.0	16	80	167	6 / 96
493522S	11/16	24.5	30.0	17	80	235	6 / 96
493524S	3/4	27.0	30.0	18	80	224	6 / 96
493526S	13/16	29.0	30.0	20	80	250	6 / 96
493528S	7/8	30.5	30.0	22	80	260	5 / 60
493530S	15/16	33.0	30.0	24	80	336	5 / 60
493532S	1	34.0	30.0	24	80	356	5 / 60
493534S	1-1/16	37.0	30.0	27	80	405	5 / 60
493536S	1-1/8	39.0	30.5	27	80	355	5 / 50
493538S	1-3/16	40.5	30.0	30	80	417	5 / 50
493540S	1-1/4	42.5	30.0	32	80	389	5 / 50

Extra Thin Wall Impact Socket

4415M 1/2"

- Finishing - phosphate sunk
- For aluminum alloy wheel
- Material - chrome molybdenum alloy steel
- Super thin wall version has less strength than a standard deep one
- DIN 3121

Thin walled design (D1)

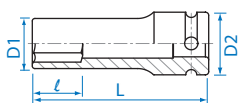

KT NO.	mm	D1 mm	D2 mm	ℓ mm	L mm		
441517M	17	23.8	25	17	80	163	6 / 96
441519M	19	25.8	30	20	80	214	6 / 96
441521M	21	27.8	30	22	80	221	6 / 96
441522M	22	29.5	30	24	80	238	6 / 96

Wheel Nut Impact Socket KT No. & D1

- Material - chrome molybdenum alloy steel
- Durable outer sleeve protects polished wheels and lug nuts
- Plastic sleeve thin wall version



4945M 1/2"

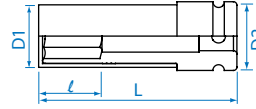

KT NO.	mm	D1 mm	D2 mm	ℓ mm	L mm		
494515M	15	25.0	26.0	25	85	160	5 / 60
494517M	17	27.3	30.0	26	85	213	5 / 60
494519M	19	29.3	30.0	26	85	232	5 / 60
494521M	21	30.9	30.0	26	85	243	5 / 60
494522M	22	32.0	31.5	25	85	266	5 / 60

4955MX 1/2"

- Plastic insert to protect the surface of the wheel rim
- 17MX: Especially for wheel mounting and dismounting on AMG-rims and/or alloy rims with deeply located wheel bolts
- 19MX: Particularly suitable for wheel mounting and assembly on SUVs e.g. PORSCHE Cayenne, Macan, AUDI Q7, Q5, VW Touareg
- 21MX: Particularly for wheel mounting and installation of aluminium rims to HYUNDAI, KIA, TOYOTA, MAZDA, TESLA

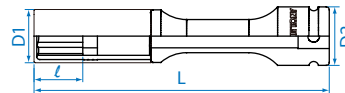

KT NO.	mm	D1 mm	D2 mm	ℓ mm	L mm		
495517MX	17	27.3	30	25	150	310	2 / 48
495519MX	19	29.3	30	25	150	339	2 / 48
495521MX	21	30.9	30	25	150	413	2 / 48

Double - Ended Impact Socket

4915M 4915S 1/2"

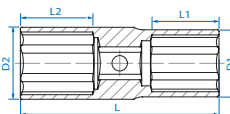

KT NO.	mm / inch	D1 mm	D2 mm	L mm	L1 mm	L2 mm		
49151719M	17 x 19	26	28	77	22	26	210	6 / 96
49151921M	19 x 21	26	28	77	23	26	200	6 / 96
49152122M	21 x 22	30	32	77	20	26	310	5 / 60
49152123M	21 x 23	30	32	77	22	26	310	5 / 60
49152426S	3/4" x 13/16"	26	28	77	23	26	200	6 / 96

Impact Star Socket

4575M

1/2"

- For torx external screw
- DIN 3121

KT NO.	Size	D1 mm	D2 mm	ℓ mm	L mm		
457510M	E10	14.0	25.0	7.5	38	68	10 / 200
457512M	E12	15.9	25.0	9.0	38	68	10 / 200
457514M	E14	17.7	25.0	10.0	38	71	10 / 200
457516M	E16	20.0	25.0	11.0	38	75	10 / 200
457518M	E18	22.0	25.0	12.5	38	78	10 / 200
457520M	E20	24.5	30.0	14.0	38	120	10 / 160

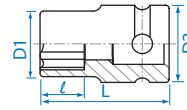

Impact Bit Socket

4015M

4015S 1/2"

- Hexagon head
- DIN 3121



KT NO.	mm	L mm	Max. torq N-m		
401505M	H5	80	36.0	73	6 / 120
401506M	H6	80	62.4	77	6 / 120
401507M	H7	80	97.0	84	6 / 120
401508M	H8	80	144.0	86	6 / 120
401509M	H9	80	229.0	97	6 / 120
401510M	H10	80	264.0	100	6 / 120
401512M	H12	80	480.0	117	6 / 120
401513M	H13	80	518.0	128	6 / 120
401514M	H14	80	650.0	137	6 / 120
401517M	H17	80	715.0	217	6 / 96
401519M	H19	80	786.0	246	6 / 96

KT NO.	inch	L mm	Max. torq N-m		
401508S	1/4	80	93.6	77	6 / 120
401510S	5/16	80	144.0	86	6 / 120
401512S	3/8	80	264.0	100	6 / 120
401516S	1/2	80	518.0	126	6 / 120

4053

4063 1/2"

- For torx internal screw
- DIN 3121



KT NO.	Size	L mm		
405320	T20	60	64	10 / 180
405325	T25	60	65	10 / 180
405327	T27	60	66	10 / 180
405330	T30	60	66	10 / 180
405340	T40	60	68	10 / 180
405345	T45	60	73	10 / 180
405350	T50	60	78	10 / 180
405355	T55	60	87	10 / 180
405360	T60	60	93	10 / 180
405370	T70	60	104	10 / 180
406325	T25	100	72	6 / 120
406327	T27	100	76	6 / 120
406330	T30	100	78	6 / 120
406340	T40	100	81	6 / 120
406345	T45	100	88	6 / 120
406350	T50	100	97	6 / 120
406355	T55	100	117	6 / 120
406360	T60	100	137	6 / 120

4055M

4055S 1/2"

- Hexagon head
- DIN 3121



KT NO.	mm	L mm	Max. torq N-m		
405504M	H4	60	20.8	64	10 / 180
405505M	H5	60	36.0	67	10 / 180
405506M	H6	60	62.4	71	10 / 180
405507M	H7	60	97.0	74	10 / 180
405508M	H8	60	144.0	79	10 / 180
405510M	H10	60	264.0	87	10 / 180
405512M	H12	60	480.0	98	10 / 180
405513M	H13	60	518.0	104	10 / 180
405514M	H14	60	650.0	110	10 / 180
405516M	H16	60	680.0	125	10 / 180
405517M	H17	60	715.0	178	10 / 80
405518M	H18	60	740.0	186	10 / 80
405519M	H19	60	786.0	195	10 / 80

KT NO.	inch	L mm	Max. torq N-m		
405506S	3/16	60	36.0	65	10 / 180
405508S	1/4	60	93.6	72	10 / 180
405510S	5/16	60	144.0	78	10 / 180
405512S	3/8	60	264.0	86	10 / 180
405514S	7/16	60	420.0	93	10 / 180
405516S	1/2	60	518.0	104	10 / 180

4056M

1/2"

- Spline head
- DIN 3121



KT NO.	Size	L mm	Max. torq N-m		
405608M	M 8	60	62.4	73	10 / 180
405610M	M10	60	144.0	81	10 / 180
405612M	M12	60	229.0	88	10 / 180



- Air pressure must not exceed 90PSI (6.3bar)
- Adjust your air tool to its lowest torque output, should this torque level not be enough, increase it gradually

CAUTION

Impact Universal Joint Socket

4B55M 4B55S 1/2"

- Special design for confined spaces
- DIN 3121



• Standard Length

KT NO.	mm	D1 mm	D2 mm	l mm	L mm	g	kg
4B5510M	10	17.0	27.5	12	64	167	10 / 120
4B5511M	11	19.0	27.5	12	64	166	10 / 120
4B5512M	12	19.0	27.5	12	64	165	10 / 120
4B5513M	13	21.8	27.5	12	64	171	10 / 120
4B5514M	14	22.0	27.5	12	64	178	10 / 120
4B5515M	15	22.0	27.5	12	64	175	10 / 120
4B5516M	16	23.9	27.5	12	64	182	10 / 120
4B5517M	17	25.0	27.5	12	64	190	10 / 120
4B5521M	21	30.0	27.5	12	64	202	10 / 120
4B5522M	22	31.7	27.5	12	64	208	10 / 120

KT NO.	Inch	D1 mm	D2 mm	l mm	L mm	g	kg
4B5512S	3/8	17.0	27.5	12	64	161	10 / 120
4B5514S	7/16	19.0	27.5	12	64	166	10 / 120
4B5516S	1/2	21.8	27.5	12	64	176	10 / 120
4B5518S	9/16	22.0	27.5	12	64	174	10 / 120
4B5520S	5/8	23.9	27.5	12	64	180	10 / 120
4B5522S	11/16	25.0	27.5	12	64	173	10 / 120
4B5526S	13/16	30.0	27.5	12	64	190	10 / 120
4B5528S	7/8	31.7	27.5	12	64	196	10 / 120
4B5530S	15/16	35.8	27.5	12	64	217	6 / 96

Impact Accessory

4147 1/2"

- Bit holder
- DIN 3121



KT NO.	Size	Overall length mm	g	kg
414708S	1/4"	48	73	12 / 216
414710S	5/16"	48	79	12 / 216
414710M	10 mm	48	79	12 / 216

414A08S 1/2"

- Quick-release
- Bit holder
- DIN 3121



KT NO.	Size	Overall length mm	g	kg
414A08S	1/4"	50	93.6	10 / 180

4260P 1/2"

- Extension bar
- DIN 3121



KT NO.	Overall length Inch	Overall length mm	g	kg
4260-03P	3	75	198	4 / 80
4260-04P	4	100	240	4 / 80
4260-05P	5	125	278	2 / 40
4260-06P	6	150	324	4 / 80
4260-08P	8	200	402	4 / 48
4260-10P	10	250	487	4 / 48
4260-12P	12	300	573	2 / 40
4260-16P	16	400	746	2 / 20

Impact Bit Socket

KT No. & D1



- Air pressure must not exceed 90PSI (6.3bar)
- Adjust your air tool to its lowest torque output, should this torque level not be enough, increase it gradually

CAUTION

1740 409616M 1/2"

- Hex bit & bit holder
- DIN 3121

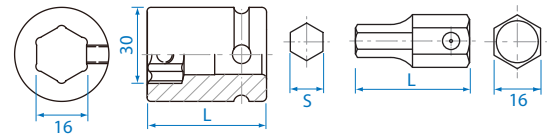

KT NO.	mm	L mm	Max. torq N-m	g	kg
174010H	H10	40	264.0	46	20 / 400
174012H	H12	40	480.0	52	20 / 400
174014H	H14	40	684.0	60	20 / 200
174017H	H17	40	680.0	73	20 / 200
174019H	H19	40	680.0	80	20 / 200
174022H	H22	40	680.0	97	12 / 120
409616M	16	38	680.0	145	10 / 160

4065M 1/2"

- Hexagon head
- DIN 3121



KT NO.	mm	L mm	Max. torq N-m	g	kg
406504M	H4	100	20.8	73	6 / 120
406505M	H5	100	36.0	78	6 / 120
406506M	H6	100	62.4	85	6 / 120
406508M	H8	100	144.0	95	6 / 120
406510M	H10	100	264.0	114	6 / 120
406512M	H12	100	480.0	138	6 / 120
406514M	H14	100	650.0	164	6 / 120

4075M 1/2"

- Hexagon head
- DIN 3121













KT NO.	mm	L mm	Max. torq N-m	g	kg
407505M	H5	150	36.0	115	6 / 120
407506M	H6	150	62.4	115	6 / 120
407508M	H8	150	144.0	116	6 / 120
407510M	H10	150	264.0	148	6 / 120
407512M	H12	150	480.0	187	6 / 120
407514M	H14	150	650.0	231	6 / 120

Impact Accessory & Set

4269

1/2"

- Torque extension bar
- Color coded and engraved with N-m and lbf-ft setting
- Helps to eliminate overtorqued lug nut

KT NO.	Color	Max. torq N-m	lbf-ft	Overall length inch	mm	
4269-08-90		90	65	7-11/16	195	192
4269-08-A0		100	75	7-11/16	195	201
4269-08-B0		110	80	7-11/16	195	217
4269-08-C0		120	90	7-11/16	195	224
4269-08-D5		135	100	7-11/16	195	238
4269-08-F0		150	110	7-11/16	195	263
4269-08-G0		160	120	7-11/16	195	304
4269-08-H5		175	130	7-11/16	195	284
4269-08-J0		190	140	7-11/16	195	331
4269-08-K0		200	150	7-11/16	195	344



How to use torque extension bar



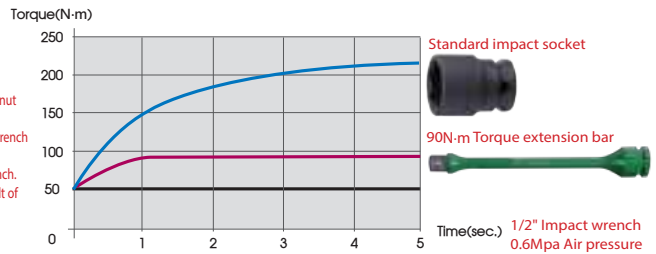









1. Use with 1/2"DR. impact wrench, don't use by hand.
2. Set air pressure 0.6 MPa(90 PSI) and adjust torque value between 190 N-m and 210 N-m.
3. Select suitable torque extension bar according to wheel nut size and indicated tightening torque.
4. Attach the torque extension bar with socket to impact wrench and apply load.
5. Check the actual tightening torque value by torque wrench.
6. Adjust air pressure or torque value according to the result of above.
7. Tight other wheel nuts in diagonal order.



4481PP1

1/2"

- Torque extension bar set

Contents	 2.58	 1 / 6
 4269-08-90	90 N-m	
 4269-08-A0	100 N-m	
 4269-08-B0	110 N-m	
 4269-08-C0	120 N-m	
 4269-08-D5	135 N-m	
 4269-08-F0	150 N-m	
 4269-08-G0	160 N-m	
 4269-08-H5	175 N-m	
 4269-08-J0	190 N-m	
 4269-08-K0	200 N-m	



10 PC.

9TE41

- Hook for torque extension bar
- Groove capacity : 22 mm

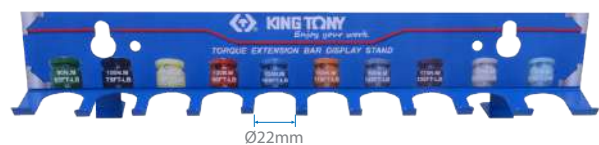

KT NO.	Overall length (mm)		
9TE41	311	196.4	1 / 24



4796P 1/2"

- Universal joint
- DIN 3121

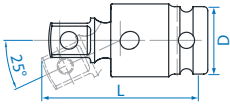

KT NO.	Overall length Inch	mm	D mm			
4796P	2-3/8	59	25	124	6	96

4797P 1/2"

- Universal joint
- DIN 3121

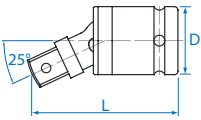

KT NO.	Overall length Inch	mm	D mm			
4797P	2-1/2	65	29.1	168	6	96

4798P 1/2"

- Universal joint

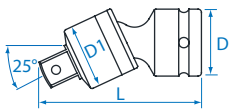

KT NO.	Overall length Inch	mm	D mm	D1 mm			
4798P	3	74	29.1	29.1	213	6	96

4799P 1/2"

- Universal joint
- Durable pinless hex ball locking design
- DIN 3121

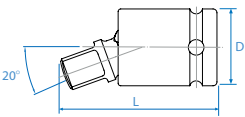

KT NO.	Overall length Inch	mm	D mm			
4799P	2-3/8	60	30	170	6	96

4873P 1/2"

- Adapter
- Convert to 3/8"
- 4873P → Max. torque : 202 N-m
- DIN 3121

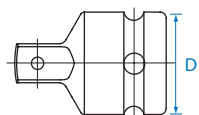

KT NO.	Spec.	D mm			
4873P	1/2"F x 3/8"M	25	66	10	160

4863P 1/2"

- Adapter
- Convert to 3/8", 3/4" drive
- 4863P → Max. torque : 202 N-m
- DIN 3121

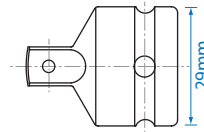

4863P & 4866P

KT NO.	Spec.			
4863P	1/2"F x 3/8"M	97	10	160
4866P	1/2"F x 3/4"M	147	8	160

90401 1/2"

- Locking ring
- High tensile rubber material

90601 1/2"

- Locking pin
- Chrome vanadium steel
- DIN 3129

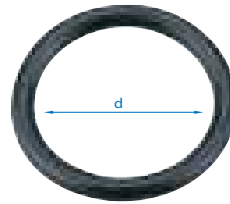

90401
90402

90601
90602

KT NO. Type \varnothing d / l Applied to socket sizes

90401	ring	3.5	19	4535M (8~14mm)	4535S (15/16"~9/16")
				4435M (8~14mm)	4435S (15/16"~9/16")
				4015M (5~14mm)	4015S (1/4"~1/2")
				4055M (4~14mm)	4055S (3/16"~1/2")
				4935M (10~14mm)	4935S (7/16"~9/16")
				4415M (17mm)	4575 (E10-E18)
				4835M (10~17mm)	

90601	pin	3.0	20	414A08S.4053.4063.4065.4075.4873.4015
				4147.4055.4056

90402	ring	3.5	23	4535M (15~46mm)	4535S (11/16"~1-1/4")
				4435M (15~46mm)	4435S (5/8"~1-1/4")
				4935M (16~30mm)	4935S (11/16"~1-1/4")
				4015M (17.19mm)	
				4415M (19.21mm)	
				4530M (15~36mm)	
				4575M (E20)	

90602	pin	3.0	25	4835M (19~30mm)
				4260.4796.4797.4863.4873.4866



Impact Socket Rail Set

4423MP

1/2"

Thin wall version



3 PC.

Contents

0.45 Kg 48

4835M 17, 19, 21

7411PP

1/2"



11 PC.

Contents

0.76 Kg 4 / 32

3575M E5, E6, E7, E8

4575M E10, E12, E14, E16, E18, E20

4863P 1/2"F x 3/8"M

Impact Socket Set

4408MP

1/2"

Metal case size (mm) :
270 x 73 x 46 (0.032 cuft)

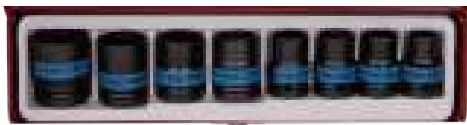

8 PC.

Contents

1.3 Kg 1 / 20

4535M 10, 12, 13, 14, 17, 19, 21, 24

Impact Socket Set

4408SP

1/2"

Metal case size (mm) :
270 x 73 x 46 (0.032 cuft)



8 PC.

Contents

1.3 Kg 1 / 20

4535S 3/8, 7/16, 1/2, 9/16, 11/16, 3/4, 13/16, 15/16

4412MP

1/2"

Metal case size (mm) :
224 x 94 x 40 (0.03 cuft)

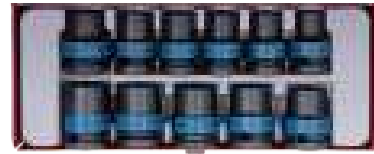

11 PC.

Contents

1.61 Kg 1 / 8

4535M 10, 11, 12, 13, 14, 15, 16, 17, 18, 19, 21

4414MP

4414SP

1/2"

Metal case size (mm) :
270 x 100 x 49 (0.047 cuft)

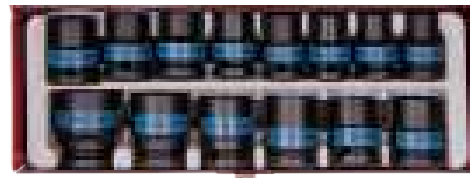

4414MP

14 PC.



4414SP

KT NO.

Contents

1.3 Kg 1 / 20

4414MP



10, 11, 12, 13, 14, 15, 16, 17, 18, 19, 21, 22, 24, 27

2.25

4414SP



3/8, 7/16, 1/2, 9/16, 5/8, 11/16, 3/4, 13/16, 7/8, 15/16, 1, 1-1/16, 1-1/8, 1-1/4

2.4

1 / 8

Impact Socket Set

4419MP

1/2"

Metal case size (mm) :
445 x 135 x 50 (0.021 cuft)

19
PC.

Contents

2.7 1 / 6

	4535M	10, 11, 12, 13, 14, 15, 16, 17, 18, 19, 21, 22, 23, 24, 26, 27, 30, 32
	4260-05P	



4410MP

Metal case size (mm) :
246 x 103 x 38 (0.034 cuft)

4410MP01

4410SP

1/2"

8
PC.



4410MP / 4410MP01



4410SP

KT NO.

Contents

2.3 1 / 12

4410MP	4435M	12, 13, 14, 17, 19, 21, 22, 23
4410MP01	4435M	12, 13, 14, 17, 19, 21, 22, 24
4410SP	4435S	1/2, 9/16, 5/8, 11/16, 3/4, 13/16, 7/8, 15/16

4416SP

1/2"

Metal case size (mm) :
445 x 135 x 50 (0.021 cuft)

14
PC.

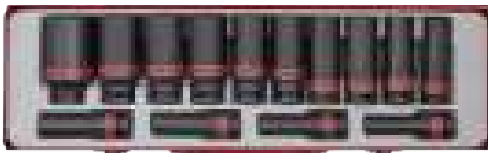

Contents

4.8 1 / 6

	4435S	3/8, 7/16, 1/2, 9/16, 5/8, 11/16, 3/4, 13/16, 7/8, 15/16, 1, 1-1/16, 1-1/8, 1-1/4
--	-------	---

4413MP

1/2"

Metal case size (mm) :
270 x 73 x 46 (0.032 cuft)

8
PC.



Contents

1.37 1 / 20

	4835M	10, 12, 13, 14, 17, 19, 21, 24
--	-------	--------------------------------

4415MP

Metal case size (mm) :
445 x 135 x 50 (0.021 cuft)

4415MP03

1/2"

15
PC.

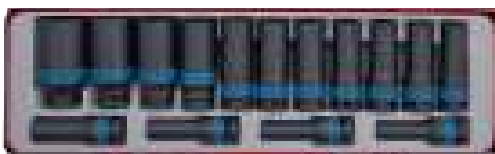

4415MP

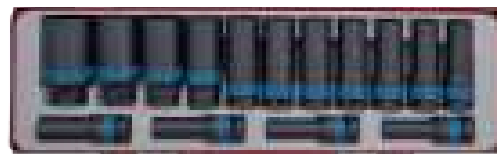

4415MP03

KT NO.

Contents

4.9 1 / 6

4415MP		10, 11, 12, 13, 14, 15, 16, 17, 18, 19, 21, 24, 26, 29, 32
4415MP03	4435M	10, 11, 12, 13, 14, 15, 16, 17, 19, 21, 22, 24, 27, 30, 32

Impact Socket Set

4815MP04

Metal case size (mm) :
445 x 135 x 50 (0.021 cuft)



4815MP05

1/2"



15
PC.

4815MP04 / 4815MP05

KT NO.		Contents	Kg	1/6
4815MP04		10, 12, 13, 14, 15, 17, 18, 19, 20, 21, 22, 24, 27, 30, 32	5.1	1 / 6
4815MP05	 4430M	8, 9, 10, 12, 13, 14, 15, 16, 17, 18, 19, 20, 21, 22, 24	4.3	1 / 6

Wheel Nut Impact Socket Set

44905MP







1/2"

- Thin wall impact socket set with plastic sleeve
- Durable outer sleeve protects polished wheels and lug nuts

Blow case size (mm) :
149 x 132 x 45 (0.031 cuft)



3
PC.

Contents	Kg	0.89	1/16
  494517M 17 mm			
  494519M 19 mm			
  494521M 21 mm			

Impact Socket Set

44906MP









1/2"

- Wheel nut impact socket
- Torque extension bar

Metal case size (mm) :
296 x 130 x 41 (0.056 cuft)



6
PC.

Contents	Kg	2.13	1/10
  494517M 17 mm			
  494519M 19 mm			
  494521M 21 mm			
 4269-08-90 90 N-m			
 4269-08-B0 110 N-m			
 4269-08-D5 135 N-m			

Wheel Nut Impact Socket Set

44904MP

1/2"

- Material - chrome molybdenum alloy steel
- Idling type protective sleeve design, reduce sheath wear and avoid damage to aluminum alloy rims
- With color management, easy to recognize the sizes







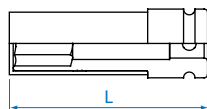

Blow case size (mm) :
160 x 135 x 50 (0.038 cuft)

Kg 1.06 1/20



4
PC.



Contents	DR.	Applicable vehicle	Size mm	L mm
  494515M 1/2" Smart 15 85.0				
  494522M 1/2" Opel 22 85.0				
  9BW4501 1/2" Mercedes Benz 17 85.5				
  9BW4502 1/2" Hyundai/Kia 21 85.5				

4405MXL







1/2"

- Thin wall impact socket set with plastic sleeve
- Durable outer sleeve protects polished wheels and lug nuts

Blow case size (mm) :
206 x 147 x 50 (0.053 cuft)



3
PC.

Contents	Kg	1.20	1/20
  495517MX 17 mm, 150mmL			
  495519MX 19 mm, 150mmL			
  495521MX 21 mm, 150mmL			

Impact Bit Socket Set

4407MP

1/2"

- For hexagon head screw
- 60mmL
- Metal case size (mm) :
198 x 105 x 32 (0.023 cuft)



7
PC.

Contents 0.94 1 / 20

4055M H4, H5, H6, H8, H10, H12, H14

4457MP

1/2"

- For hexagon head screw
- 100mmL
- Metal case size (mm) :
244 x 118 x 37 (0.038 cuft)

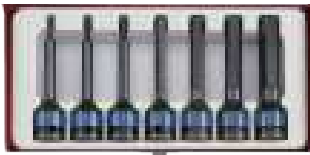

7
PC.

Contents 1.44 1 / 18

4065M H4, H5, H6, H8, H10, H12, H14

4476MP

1/2"

- For hexagon head screw
- 150mmL
- Metal case size (mm) :
244 x 118 x 37(0.038 cuft)



6
PC.

Contents 1.47 1 / 18

4075M H5, H6, H8, H10, H12, H14

4418MP

1/2"

- For hexagon head screw
- 60mmL
- Metal case size (mm) :
270 x 73 x 46 (0.032 cuft)

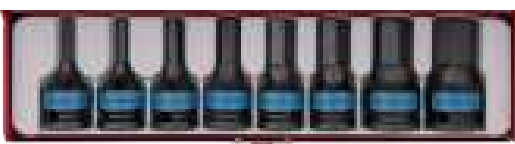

8
PC.

Contents 1.34 1 / 20

4055M H5, H6, H8, H10, H12, H14, H17, H19

4417PP

1/2"

- For torx internal screw
- 60mmL
- Metal case size (mm) :
198 x 105 x 32 (0.023 cuft)



7
PC.

Contents 0.94 1 / 20

4053 T25, T30, T40, T45, T50, T55, T60

4467PP

1/2"

- For torx internal screw
- 100mmL
- Metal case size (mm) :
244 x 118 x 37 (0.038 cuft)

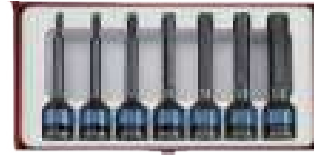

7
PC.

Contents 1.31 1 / 18

4063 T25, T30, T40, T45, T50, T55, T60

Standard Impact Socket

KT No. & D1

6510M

3/4"

- Lightweight type
- DIN 3121

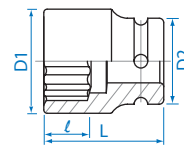

KT NO.	mm	D1 mm	D2 mm	l mm	L mm		
651017M	17	29.0	38	10	50	225	8 / 96
651018M	18	30.0	38	10	50	230	8 / 96
651019M	19	32.0	38	10	50	240	8 / 96
651021M	21	35.0	38	13	50	252	8 / 96
651022M	22	36.0	38	13	50	255	8 / 96
651023M	23	37.0	38	15	50	256	8 / 96
651024M	24	38.0	38	15	50	265	8 / 96
651026M	26	38.0	38	15	53	257	6 / 48
651027M	27	42.0	38	18	53	299	6 / 48
651028M	28	44.0	38	18	53	325	6 / 48
651029M	29	45.0	38	18	53	330	6 / 48
651030M	30	46.0	38	20	53	337	6 / 48

Standard Impact Socket



KT No. & D1 

6515M

3/4"

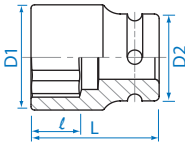
- Lightweight type
- DIN 3121





KT NO.	mm	D1 mm	D2 mm	ℓ mm	L mm		
651514M	14	25.0	38	10	50	206	8 / 96
651515M	15	26.0	38	10	50	210	8 / 96
651516M	16	27.5	38	10	50	216	8 / 96
651517M	17	29.0	38	10	50	228	8 / 96
651518M	18	30.0	38	10	50	232	8 / 96
651519M	19	32.0	38	10	50	241	8 / 96
651521M	21	35.0	38	13	50	254	8 / 96
651522M	22	36.0	38	13	50	260	8 / 96
651523M	23	37.0	38	15	50	261	8 / 96
651524M	24	38.0	38	15	50	265	8 / 96
651525M	25	38.0	38	15	53	275	8 / 96
651526M	26	38.0	38	15	53	259	6 / 48
651527M	27	42.0	38	18	53	311	6 / 48
651528M	28	44.0	38	18	53	332	6 / 48
651529M	29	45.0	38	18	53	345	6 / 48
651530M	30	46.0	38	20	53	348	6 / 48

6535M

3/4"

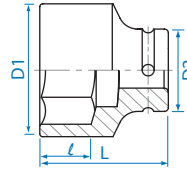
- DIN 3121





KT NO.	mm	D1 mm	D2 mm	ℓ mm	L mm		
653513M	13	22.0	38	16	50	205	8 / 96
653517M	17	29.0	44	10	50	309	6 / 48
653518M	18	30.0	44	10	50	314	6 / 48
653519M	19	32.0	44	10	50	323	6 / 48
653521M	21	35.0	44	13	50	336	6 / 48
653522M	22	36.0	44	13	50	340	6 / 48
653523M	23	37.0	44	15	50	339	6 / 48
653524M	24	38.0	44	15	50	343	6 / 48
653526M	26	40.0	44	15	53	364	6 / 48
653527M	27	42.0	44	18	53	379	6 / 48
653528M	28	44.0	44	18	53	390	6 / 48
653529M	29	45.0	44	18	53	399	6 / 48
653530M	30	46.0	44	20	53	349	6 / 48
653531M	31	47.0	44	20	53	413	6 / 48
653532M	32	48.0	44	20	57	456	6 / 36
653533M	33	50.0	44	20	57	481	6 / 36
653534M	34	51.0	44	22	57	488	6 / 36
653535M	35	52.0	44	22	57	499	6 / 36
653536M	36	53.0	44	22	57	508	6 / 36
653538M	38	56.0	44	22	57	553	4 / 32
653540M	40	58.0	44	22	58	590	4 / 32
653541M	41	59.0	44	24	58	584	4 / 32
653542M	42	61.0	44	24	58	622	2 / 24
653543M	43	62.0	44	24	58	638	2 / 24
653544M	44	64.0	44	24	62	706	2 / 24
653545M	45	64.0	44	24	62	704	2 / 24
653546M	46	66.0	44	24	62	730	2 / 24
653548M	48	68.0	44	26	65	807	2 / 24
653550M	50	71.0	44	26	65	870	1 / 20
653552M	52	74.0	54	30	68	1083	1 / 20
653554M	54	76.0	54	30	68	1151	1 / 20
653555M	55	77.0	54	30	70	1196	1 / 20
653557M	57	79.0	54	32	70	1211	1 / 20
653558M	58	81.0	54	32	70	1275	1 / 20
653560M	60	84.0	54	32	70	1424	1 / 20
653563M	63	83.5	54	40	80	1317	1 / 12
653565M	65	85.5	54	43	80	1324	1 / 12
653570M	70	92.0	54	45	83	1571	1 / 12

6530M

3/4"

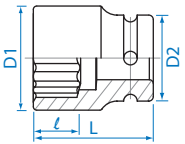
- DIN 3129, ISO 2725-2



KT NO.	mm	D1 mm	D2 mm	ℓ mm	L mm		
653017M	17	29.0	44	10	50	319	6 / 48
653019M	19	32.0	44	10	50	322	6 / 48
653021M	21	35.0	44	13	50	333	6 / 48
653022M	22	36.0	44	13	50	335	6 / 48
653023M	23	37.0	44	15	50	335	6 / 48
653024M	24	38.0	44	15	50	338	6 / 48
653026M	26	40.0	44	15	53	360	6 / 48
653027M	27	42.0	44	18	53	361	6 / 48
653028M	28	44.0	44	18	53	384	6 / 48
653029M	29	45.0	44	18	53	387	6 / 48
653030M	30	46.0	44	20	53	390	6 / 48
653032M	32	48.0	44	20	57	440	6 / 36
653033M	33	50.0	44	20	57	476	6 / 36
653034M	34	51.0	44	22	57	479	6 / 36
653035M	35	52.0	44	22	57	488	6 / 36
653036M	36	53.0	44	22	57	489	6 / 36
653038M	38	56.0	44	22	57	534	4 / 32
653040M	40	58.0	44	22	58	577	4 / 32
653041M	41	59.0	44	24	58	573	4 / 32
653042M	42	61.0	44	24	58	610	2 / 24
653046M	46	66.0	44	24	62	723	2 / 24
653063M	63	84.5	54	40	80	1352	1 / 12
653065M	65	86.5	54	43	80	1381	1 / 12
653070M	70	92.0	54	45	83	1445	1 / 12

Standard Impact Socket

KT No. & D1



6535S

3/4"

ANSI / ASME B107.2

KT NO.	inch	D1 mm	D2 mm	ℓ mm	L mm	g	kg
653522S	11/16	29	38	10	50	226	8 / 96
653524S	3/4	32	38	10	50	240	8 / 96
653526S	13/16	35	38	13	50	254	8 / 96
653528S	7/8	36	38	13	50	259	8 / 96
653530S	15/16	37	38	15	50	256	8 / 96
653532S	1	38	38	15	53	274	8 / 96
653534S	1-1/16	42	40	18	53	328	6 / 48
653536S	1-1/8	44.7	40	18	53	360	6 / 48
653538S	1-3/16	46	40	20	53	368	6 / 48
653540S	1-1/4	48	44	20	57	459	6 / 36
653542S	1-5/16	50	44	20	57	485	6 / 36
653544S	1-3/8	52	44	22	57	495	6 / 36
653546S	1-7/16	54	44	22	57	526	6 / 36
653548S	1-1/2	56	44	22	57	545	4 / 32
653550S	1-9/16	58	44	22	58	596	4 / 32
653552S	1-5/8	59	44	24	58	588	4 / 32
653554S	1-11/16	63.5	44	25	58	681	2 / 24

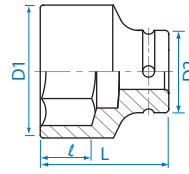

KT NO.	inch	D1 mm	D2 mm	ℓ mm	L mm	g	kg
653556S	1-3/4	64	44	25	62	710	2 / 24
653558S	1-13/16	66	44	25.5	62	718	2 / 24
653560S	1-7/8	68	44	27	65	806	2 / 24
653562S	1-15/16	70	44	27	65	951	1 / 20
653564S	2	72	54	28	68	1048	1 / 20
653566S	2-1/16	74	54	30	68	1078	1 / 20
653568S	2-1/8	76	54	30	68	1142	1 / 20
653570S	2-3/16	77	54	30.5	70	1141	1 / 20
653572S	2-1/4	79	54	32.5	70	1178	1 / 20
653574S	2-5/16	81	54	32.5	70	1266	1 / 20
653576S	2-3/8	84	54	33.5	70	1346	1 / 20

Deep Impact Socket

6435M

3/4"

DIN 3121

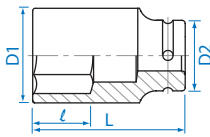

KT NO.	mm	D1 mm	D2 mm	ℓ mm	L mm	g	kg
643519M	19	32	44	16	90	546	1 / 24
643521M	21	35	44	18	90	567	1 / 24
643522M	22	36	44	18	90	578	1 / 24
643523M	23	37	44	23	90	596	1 / 24
643524M	24	38	44	23	90	598	1 / 24
643525M	25	40	44	25	90	630	1 / 24
643526M	26	40	44	25	90	600	1 / 24
643527M	27	42	44	27	90	625	1 / 24
643528M	28	44	44	27	90	666	1 / 24
643529M	29	45	44	27	90	666	1 / 24
643530M	30	46	44	27	90	693	1 / 24
643532M	32	48	44	30	90	727	1 / 24
643533M	33	50	44	30	90	792	1 / 24
643534M	34	51	44	32	90	795	1 / 24
643535M	35	52	44	32	90	811	1 / 24
643536M	36	53	44	32	90	818	1 / 24
643538M	38	56	44	34	90	882	1 / 24
643540M	40	58	44	34	90	926	1 / 24
643541M	41	59	44	34	90	936	1 / 24
643542M	42	61	44	36	95	1047	1 / 24
643543M	43	62	44	38	95	1092	1 / 10
643544M	44	64	44	38	95	1159	1 / 10
643546M	46	66	44	38	95	1239	1 / 10
643548M	48	68	44	40	95	1218	1 / 10
643550M	50	71	44	40	95	1317	1 / 10
643555M	55	77	54	45	100	1799	1 / 10
643560M	60	84.5	54	50	100	2042	1 / 6
643565M	65	86.5	54	54	100	1904	1 / 6

6435S

3/4"

ANSI / ASME B107.2

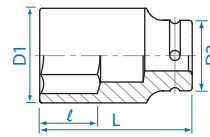

KT NO.	inch	D1 mm	D2 mm	ℓ mm	L mm	g	kg
643524S	3/4	32	38	16	90	432	1 / 24
643526S	13/16	35	38	18	90	473	1 / 24
643528S	7/8	36	38	18	90	495	1 / 24
643530S	15/16	37	38	23	90	495	1 / 24
643532S	1	38	38	25	90	478	1 / 24
643534S	1-1/16	42	44	27	90	624	1 / 24
643536S	1-1/8	44.7	44	27	90	665	1 / 24
643538S	1-3/16	46	44	27	90	692	1 / 24
643540S	1-1/4	48	44	30	90	725	1 / 24
643542S	1-5/16	50	44	30	90	782	1 / 24
643544S	1-3/8	52	44	32	90	807	1 / 24
643546S	1-7/16	54	44	32	90	845	1 / 24
643548S	1-1/2	56	44	34	90	874	1 / 24
643550S	1-9/16	58	44	34	90	923	1 / 24
643552S	1-5/8	59	44	34	90	924	1 / 24
643554S	1-11/16	63.5	44	38	95	1181	1 / 10
643556S	1-3/4	64	44	38	95	1139	1 / 10
643558S	1-13/16	66	44	38	95	1212	1 / 10
643560S	1-7/8	68	54	40	95	1354	1 / 10
643562S	1-15/16	70	54	40	95	1256	1 / 10
643564S	2	72	54	40	95	1476	1 / 10

Thin Wall Impact Socket

KT No. & D1



6835M

3/4"

- DIN 3121

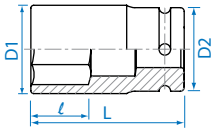

KT NO.	mm	D1 mm	D2 mm	ℓ mm	L mm	g	kg	1/24
683517M	17	28.0	44	16	60	346	6	48
683519M	19	30.0	44	16	60	351	6	48
683521M	21	33.0	44	18	60	369	6	48
683522M	22	34.0	44	18	60	372	6	48
683523M	23	35.0	44	23	60	373	6	48
683524M	24	36.5	44	23	60	382	6	48
683526M	26	39.0	44	25	80	397	1	24
683527M	27	40.0	44	26	80	424	1	24
683529M	29	43.0	44	26	80	455	1	24
683530M	30	44.0	44	26	80	555	1	24
683532M	32	46.5	44	26	80	512	1	24

6935M

3/4"

- DIN 3121

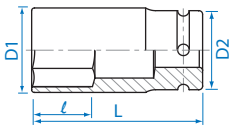

KT NO.	mm	D1 mm	D2 mm	ℓ mm	L mm	g	kg	1/24
693519M	19	30.0	44	16	90	513	1	24
693521M	21	33.0	44	18	90	546	1	24
693522M	22	34.0	44	18	90	541	1	24
693523M	23	35.0	44	23	90	519	1	24
693524M	24	36.5	44	23	90	573	1	24
693526M	26	39.0	44	25	90	578	1	24
693527M	27	40.0	44	27	90	574	1	24
693529M	29	43.0	44	27	90	578	1	24
693530M	30	44.0	44	27	90	622	1	24
693532M	32	46.5	44	30	90	683	1	24

6935S

3/4"

- ANSI / ASME B107.2

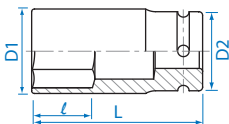

KT NO.	inch	D1 mm	D2 mm	ℓ mm	L mm	g	kg	1/24
693524S	3/4	30.0	38	16	90	370	1	24
693526S	13/16	33.0	38	18	90	380	1	24
693528S	7/8	34.0	38	18	90	385	1	24
693530S	15/16	36.5	38	23	90	415	1	24
693532S	1	38.0	38	23	90	500	1	24
693534S	1-1/16	40.0	44	25	90	654	1	24
693536S	1-1/8	43.0	44	25	90	680	1	24
693538S	1-3/16	44.0	44	27	90	684	1	24
693540S	1-1/4	46.5	44	30	90	733	1	24

Impact Star Socket

6575M

3/4"

- For torx external screw
- DIN 3121

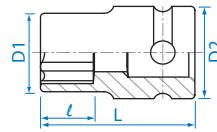

KT NO.	Size	D1 mm	D2 mm	ℓ mm	L mm	g	kg	1/24
657524M	E24	32.5	44.0	17.0	50	334	6	48
657526M	E26	35.0	44.0	19.0	60	402	6	48
657528M	E28	36.5	44.0	25.5	60	401	6	48
657530M	E30	37.5	44.0	27.0	65	428	1	24
657532M	E32	39.5	44.0	29.0	65	447	1	24

Deep Impact Star Socket

6475M

3/4"

- For torx external screw
- DIN 3121
- For the operation of cylinder head bolts
- E18 application MAN M 2000 / Bus with D 08 engine
- E20 application MAN F 2000 / F 90/ F 8/ Bus with D 25 and D 28 engines
- E24 application MAN D20 engine

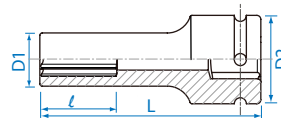

KT NO.	Size	D1 mm	D2 mm	ℓ mm	L mm	g	kg	1/24
647518M	E18	26.5	44.0	12.5	110	592	1	10
647520M	E20	29.0	44.0	14.0	110	627	1	10
647522M	E22	31.0	44.0	15.0	110	662	1	10
647524M	E24	32.5	44.0	17.0	110	693	1	10

Rear Wheel Socket

KT No. & D1



6514M

3/4"

- 4 points
- DIN 3121

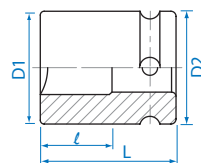

KT NO.	Size	D1 mm	D2 mm	ℓ mm	L mm	g	kg	1/24
651417M	17	39.8	34	28	53	353	1	24
651419M	19	39.8	34	28	53	339	1	24
651420M	20	41.8	36	28	53	381	1	24
651421M	21	41.8	36	28	53	369	1	24

Impact Bit Socket

KT No. & D1



6015M

3/4"

- Hexagon head
- DIN 3121



KT NO.	mm	L mm	Max. torq N-m		
601514M	H14	87	684	310	2 / 48
601517M	H17	87	1136	342	2 / 48
601519M	H19	87	1577	365	2 / 48
601521M	H21	87	2134	508	1 / 24
601522M	H22	87	2436	524	1 / 24
601524M	H24	87	2436	546	1 / 24
601527M	H27	87	2436	597	1 / 24
601530M	H30	87	2436	710	1 / 24
601532M	H32	87	2436	750	1 / 24

609616MxxH

609622MxxH 3/4"

- DIN 3121

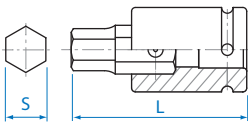

609616MxxH



609622MxxH

KT NO.	S mm	mm	L (mm)	Max. torq N-m		
609616M10H	H10	16	77	264	416	4 / 40
609616M12H	H12	16	77	480	422	4 / 40
609616M14H	H14	16	77	684	430	4 / 40
609616M17H	H17	16	77	880	443	4 / 40
609616M19H	H19	16	77	880	450	4 / 40
609616M22H	H22	16	77	880	473	4 / 40
609622M19H	H19	22	93	1577	670	1 / 24
609622M22H	H22	22	93	2436	692	1 / 24
609622M24H	H24	22	93	2436	706	1 / 24
609622M27H	H27	22	93	2436	730	1 / 24
609622M30H	H30	22	93	2436	744	1 / 24
609622M32H	H32	22	93	2436	783	1 / 24

1740

3/4"

609616M 3/4"

- Hex bit & bit holder
- DIN 3121

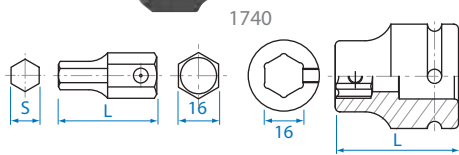

KT NO.	S mm	L mm	Max. torq N-m		
174010H	H10	40	264	46	20 / 400
174012H	H12	40	480	55	20 / 400
174014H	H14	40	684	61	20 / 200
174017H	H17	40	880	72	20 / 200
174019H	H19	40	880	83	20 / 200
174022H	H22	40	880	102	12 / 120
609616M	16	52	-	370	6 / 48

1954

3/4"

609622M 3/4"

- Hex bit & bit holder
- DIN 3121

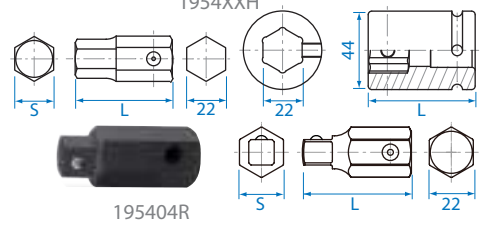

KT NO.	S mm	L mm	Max. torq N-m		
195419H	H19	54.5	1577	159	12 / 120
195422H	H22	54.5	2436	176	12 / 120
195424H	H24	54.5	2436	191	10 / 100
195427H	H27	54.5	2436	217	10 / 100
195430H	H30	54.5	2436	248	6 / 60
195432H	H32	54.5	2436	276	6 / 60
609622M	22	60.0	-	530	6 / 48
195404R	1/2"M	54.5	-	133	12 / 120

Impact Accessory

6797P

3/4"

- Universal joint
- DIN 3121

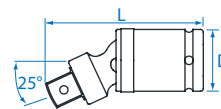

6797P

KT NO.	Overall length inch	mm	D mm		
6797P	4-1/2	114	44	738	2 / 20

6798P

3/4"

- Universal joint
- DIN 3121

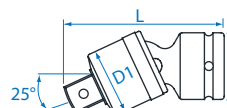

6798P

KT NO.	Overall length inch	mm	D (mm)	D1 (mm)		
6798P	4-1/4	108	44	44	749	2 / 20

Impact Accessory

KT No. & D1



6260

- Extension bar
- DIN 3121

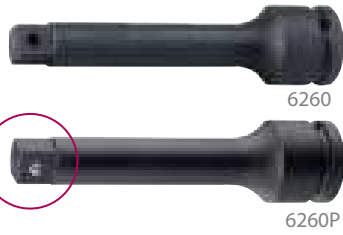

6260

6260P

6260P 3/4"

90403

- Locking ring
- High tensile rubber material

90404

90405 3/4"

90603

- Locking pin
- Chrome vanadium steel
- DIN 3129

90604

90607 3/4"

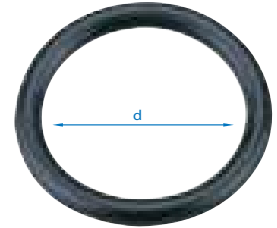

90603

90604

90607

90403

90404

90405

KT NO.

Overall length
inch mm



KT NO.	Overall length inch	mm	Weight (g)	Packaging
6260-04	4	100	566	2 / 20
6260-07	7	175	864	2 / 20
6260-10	10	250	1145	1 / 16
6260-13	13	330	1450	1 / 10
6260-04P	4	100	566	2 / 20
6260-07P	7	175	864	2 / 20
6260-10P	10	250	1145	1 / 16
6260-13P	13	330	1450	1 / 10

6864

- Adapter
- Convert to 1/2" drive
- 6864 → Max. torque : 512 N·m
- DIN 3121

6864P

6868

6868P 3/4"



6864 / 6864P
6868 / 6868P

6864 & 6868

6864P & 6868P

KT NO.

Spec.

D
(mm)



KT NO.	Spec.	D (mm)	Weight (g)	Packaging
6864	3/4"F x 1/2"M	44	311	6 / 48
6868	3/4"F x 1"M	44	445	6 / 48
6864P	3/4"F x 1/2"M	44	311	6 / 48
6868P	3/4"F x 1"M	44	445	6 / 48

6874

- Adapter
- Convert to 1/2" drive
- 6874 → Max. torque : 512 N·m
- DIN 3121

6874P

3/4"



6874 / 6874P

6874

6874P

KT NO.

Spec.

D
(mm)



KT NO.	Spec.	D (mm)	Weight (g)	Packaging
6874	3/4"F x 1/2"M	38	233	6 / 48
6874P	3/4"F x 1/2"M	38	233	6 / 48

KT NO. Type \varnothing d / l Applied to socket sizes

90403	ring	3.5	33	6015M (14~19mm) 6435S (3/4"~1") 6510M (17~30mm) 6535S (1 1/16"~1-3/16") 6515M (17~30mm) 6935S (3/4"~1")
90607	pin	3.0	30	6874
90404	ring	5.5	37	6535M (17~46mm) 6535S (1-1/4"~1-13/16") 6435M (19~46mm) 6435S (1-1/16"~1-13/16") 6935M (19~32mm) 6935S (1-1/16"~1-1/4") 6015M (21~27mm) 6260.6797.6798.6864
90603	pin	4.0	35	6530M (17~46mm) 6868 6835M (17~32mm) 609616M.609622M
90405	ring	5.5	44	6535M (48~65mm) 6535S (1-7/8"~2-3/8") 6435M (48~50mm) 6435S (1-7/8"~2")
90604	pin	4.0	45	

Impact Bit Socket Set

6411MP

3/4"

Metal case size (mm) :
270 x 100 x 49 (0.048 cuft)



11
PC.

Contents



2.77



1 / 8

	6096M	16, 22
	1740	H10, H12, H14, H17
	1954	H19, H22, H24, H27, H32

Impact Socket Set

6408MP

6408MP10

6408SP10

3/4"

Metal case size (mm) :
241 x 124 x 68 (0.07 cuft)



8
PC.

6408MP / 6408MP10 / 6408SP10

KT NO.		Contents		
6408MP	6535M	19, 22, 24, 27, 30, 32, 36, 38	3.9	1 / 6
6408MP10	6515M	19, 22, 24, 27, 30	3.9	
	6535M	32, 36, 38		
6408SP10	6535S	3/4, 7/8, 15/16, 1-1/16, 1-3/16, 1-1/4, 1-7/16, 1-1/2	3.8	

6409MP

6409MP03

6409SP10

3/4"

Metal case size (mm) :
445 x 100 x 65 (0.10 cuft)



6409MP / 6409MP03



6409SP10

8
PC.

KT NO.		Contents		
6409MP	6535M	26, 29, 30, 32, 34, 35, 36, 38	4.7	1 / 2
6409MP03	6535M	21, 22, 24, 27, 30, 32, 36, 41	4.7	
6409SP10	6535S	1, 1-1/16, 1-1/8, 1-1/4, 1-5/16, 1-3/8, 1-7/16, 1-1/2	4.8	

6410MP

6410SP

3/4"

Metal case size (mm) :
445 x 100 x 65 (0.10 cuft)

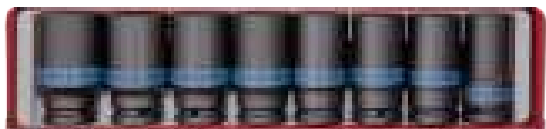

6410MP

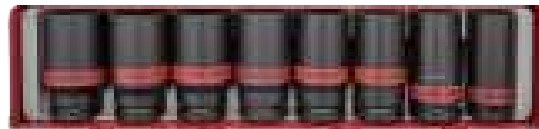

6410SP

8
PC.

KT NO.		Contents	7.1	1 / 2
6410MP	6435M	26, 29, 30, 32, 34, 35, 36, 38		
6410SP	6435S	1, 1-1/16, 1-1/8, 1-1/4, 1-5/16, 1-3/8, 1-7/16, 1-1/2		

Standard Impact Socket

8535M

1"

▪ DIN 3129, ISO 2725-2

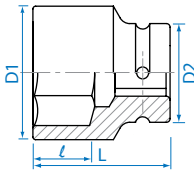

8535S

1"

▪ ANSI / ASME B107.2

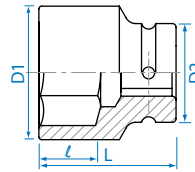

KT NO.	mm	D1 mm	D2 mm	ℓ mm	L mm	g	kg
853519M	19	35	54	15	58	508	1 / 24
853521M	21	37	54	15	58	537	1 / 24
853522M	22	38	54	15	58	548	1 / 24
853523M	23	39	54	17	58	544	1 / 24
853524M	24	41	54	17	58	562	1 / 24
853525M	25	42	54	17	58	562	1 / 24
853526M	26	43	54	19	58	564	1 / 24
853527M	27	44	54	19	58	565	1 / 24
853528M	28	45	54	19	58	570	1 / 24
853529M	29	47	54	19	58	591	1 / 24
853530M	30	48	54	20	60	592	1 / 24
853532M	32	51	54	20	62	647	1 / 24
853533M	33	52	54	20	62	662	1 / 24
853534M	34	53	54	20	62	665	1 / 24
853535M	35	54	54	20	62	665	1 / 24
853536M	36	56	54	20	65	721	1 / 24
853537M	37	56	54	22	65	698	1 / 24
853538M	38	58	54	22	65	733	1 / 24
853540M	40	60	54	22	65	758	1 / 24
853541M	41	61	54	22	70	824	1 / 24
853542M	42	64	54	22	70	905	1 / 20
853544M	44	67	54	26	70	978	1 / 20
853545M	45	67	54	26	70	960	1 / 20
853546M	46	68	54	26	75	1033	1 / 20
853548M	48	70	54	26	75	1061	1 / 20
853550M	50	73	54	26	75	1170	1 / 20
853552M	52	75	54	30	80	1244	1 / 12
853553M	53	76	54	30	80	1278	1 / 12
853554M	54	78	54	30	80	1351	1 / 12
853555M	55	79	54	32	83	1435	1 / 12
853558M	58	83	54	32	83	1514	1 / 12
853560M	60	86	54	32	87	1693	1 / 12
853563M	63	90	54	34	87	1750	1 / 12
853565M	65	92	54	34	90	1750	1 / 12
853566M	66	94	54	34	90	1889	1 / 12
853568M	68	95	54	34	90	1963	1 / 12
853570M	70	97	54	34	93	2036	1 / 8
853571M	71	99	86	36	93	2917	1 / 8
853575M	75	104	86	36	95	3120	1 / 8
853580M	80	110	86	43	95	3387	1 / 4
853585M	85	115	86	43	95	3532	1 / 4
853590M	90	122	86	43	100	4004	1 / 4
853595M	95	130	95	52	105	4924	1 / 2
8535A0M	100	136	95	51	105	4972	1 / 2

KT NO.	inch	D1 mm	D2 mm	ℓ mm	L mm	g	kg
853524S	3/4	35	54	15	58	528	1 / 24
853526S	13/16	37	54	15	58	548	1 / 24
853528S	7/8	38	54	15	58	538	1 / 24
853530S	15/16	41	54	17	58	568	1 / 24
853532S	1	42	54	17	58	559	1 / 24
853534S	1-1/16	44	54	19	58	566	1 / 24
853536S	1-1/8	47	54	19	58	586	1 / 24
853538S	1-3/16	48	54	20	60	600	1 / 24
853540S	1-1/4	51	54	20	62	659	1 / 24
853542S	1-5/16	52	54	20	62	660	1 / 24
853544S	1-3/8	54	54	20	62	660	1 / 24
853546S	1-7/16	56	54	20	65	713	1 / 24
853548S	1-1/2	58	54	22	65	728	1 / 24
853550S	1-9/16	60	54	22	65	758	1 / 24
853552S	1-5/8	61	54	22	70	822	1 / 24
853554S	1-11/16	64	54	22	70	886	1 / 20
853556S	1-3/4	67	54	26	70	968	1 / 20
853558S	1-13/16	68	54	26	75	1075	1 / 20
853560S	1-7/8	70	54	26	75	1057	1 / 20
853562S	1-15/16	72	54	26	75	1100	1 / 20
853564S	2	74	54	30	75	1170	1 / 20
853566S	2-1/16	75	54	30	80	1225	1 / 12
853568S	2-1/8	78	54	30	80	1355	1 / 12
853570S	2-3/16	79	54	32	83	1423	1 / 12
853572S	2-1/4	82	54	32	83	1486	1 / 12
853574S	2-5/16	83	54	32	83	1459	1 / 12
853576S	2-3/8	86	54	32	87	1681	1 / 12
853578S	2-7/16	88	54	34	87	1681	1 / 12
853580S	2-1/2	90	54	34	87	1704	1 / 12
853582S	2-9/16	92	54	34	90	1881	1 / 12
853584S	2-5/8	94	54	34	90	1795	1 / 12
853586S	2-11/16	95	54	34	90	1931	1 / 12
853588S	2-3/4	97	54	34	93	2114	1 / 8
853590S	2-13/16	99	86	36	93	2869	1 / 8
853592S	2-7/8	102	86	36	93	2997	1 / 8
853594S	2-15/16	104	86	36	95	3161	1 / 8
853596S	3	106	86	36	95	3279	1 / 8
8535A0S	3-1/8	110	86	43	95	3386	1 / 4
8535A4S	3-1/4	112	86	43	95	3342	1 / 4
8535A8S	3-3/8	117	86	43	100	3873	1 / 4
8535B2S	3-1/2	122	86	43	100	4148	1 / 4

Deep Impact Socket

8435M

1"

▪ DIN 3121

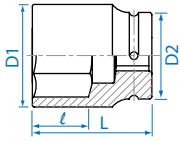

KT NO.	mm	D1 mm	D2 mm	l mm	L mm	g	kg
843524M	24	41	54	25	90	874	1 / 24
843527M	27	44	54	25	90	871	1 / 24
843528M	28	45	54	25	90	887	1 / 24
843530M	30	48	54	28	90	908	1 / 24
843532M	32	51	54	28	90	953	1 / 24
843533M	33	52	54	28	92	1016	1 / 24
843534M	34	53	54	28	92	988	1 / 24
843535M	35	54	54	28	92	1020	1 / 24
843536M	36	56	54	32	92	1034	1 / 24
843538M	38	58	54	32	92	1048	1 / 24
843540M	40	60	54	32	92	1094	1 / 24
843541M	41	61	54	32	92	1103	1 / 24
843542M	42	64	54	32	92	1236	1 / 24
843546M	46	68	54	35	95	1329	1 / 10
843548M	48	70	54	35	95	1378	1 / 10
843550M	50	73	54	35	95	1484	1 / 10
843552M	52	75	54	40	100	1594	1 / 6
843554M	54	78	54	40	100	1714	1 / 6
843555M	55	79	54	40	100	1706	1 / 6
843558M	58	83	54	42	100	1887	1 / 6
843560M	60	86	54	42	100	2022	1 / 6
843565M	65	92	54	50	110	2133	1 / 6
843570M	70	97	54	59	110	2285	1 / 6

8435S

1"

▪ ANSI / ASME B107.1

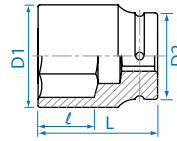

KT NO.	inch	D1 mm	D2 mm	l mm	L mm	g	kg
843530S	15/16	40.8	54	25	90	872	1 / 24
843532S	1	42	54	25	90	847	1 / 24
843534S	1-1/16	44	54	25	90	868	1 / 24
843536S	1-1/8	46.3	54	25	90	911	1 / 24
843538S	1-3/16	48	54	28	90	926	1 / 24
843540S	1-1/4	51	54	28	90	980	1 / 24
843542S	1-5/16	52	54	28	92	1010	1 / 24
843544S	1-3/8	54	54	28	92	1022	1 / 24
843546S	1-7/16	56	54	32	92	1017	1 / 24
843548S	1-1/2	58	54	32	92	1048	1 / 24
843550S	1-9/16	60	54	32	92	1096	1 / 24
843552S	1-5/8	61	54	32	92	1097	1 / 24
843554S	1-11/16	64	54	32	92	1211	1 / 24
843556S	1-3/4	67	54	32	92	1312	1 / 12
843558S	1-13/16	68	54	35	95	1322	1 / 12
843560S	1-7/8	70	54	35	95	1382	1 / 6
843562S	1-15/16	72	54	35	95	1450	1 / 6
843564S	2	74	54	35	95	1510	1 / 6
843566S	2-1/16	75	54	40	100	1589	1 / 6
843568S	2-1/8	78	54	40	100	1729	1 / 6
843570S	2-3/16	79	54	40	100	1646	1 / 6
843572S	2-1/4	82	54	42	100	1837	1 / 6

Thin Wall Impact Socket

8835M

1"

- Thin wall version
- 6 points
- Metric size
- DIN 3121

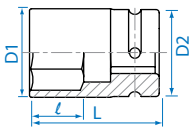

KT NO.	mm	D1 mm	D2 mm	l mm	L mm	g	kg
883524M	24	38.0	54	26	80	690	1 / 24
883527M	27	42.0	54	26	80	710	1 / 24
883529M	29	44.0	54	26	80	750	1 / 24
883530M	30	46.0	54	30	80	750	1 / 24
883532M	32	48.0	54	30	80	743	1 / 24
883533M	33	49.0	54	30	80	776	1 / 24
883534M	34	50.0	54	30	80	761	1 / 24
883535M	35	52.0	54	32	80	800	1 / 24
883536M	36	53.0	54	32	80	781	1 / 24
883538M	38	56.0	54	32	80	831	1 / 24
883541M	41	59.5	54	32	80	882	1 / 24

Rear Wheel Socket

8514M

8514S

8524M 1"

- 4 points
- DIN 3121



8514M

8524M

8514S

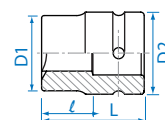

KT NO.	SQ	D1 mm	D2 mm	l mm	L mm	g	kg
851417M	17	40.0	54	30.0	60	612	1 / 24
851419M	19	42.0	54	30.0	60	611	1 / 24
851420M	20	43.0	54	30.0	60	625	1 / 24
851421M	21	44.0	54	30.0	60	618	1 / 24
851422M	22	45.5	54	30.0	60	629	1 / 24
852421M	21	44.0	48	30.0	60	502	1 / 24
851426S	13/16	44	54	30.0	60	617	1 / 24

Rear Wheel Socket

8534M



- 4 points
- DIN 3121

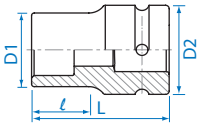

KT NO.	SQ	D1 mm	D2 mm	ℓ mm	L mm	g	kg
853417M	17	38.0	54	23.5	76	658	1 / 24
853419M	19	43.0	54	23.5	76	717	1 / 24
853421M	21	47.0	54	23.5	76	773	1 / 24

8545M



- DIN 3121
- 17SQ x35MM Isuzu, Mitsubishi, Nissan, Mazda
- 19SQ x41MM Mazda
- 20SQ x38MM Hino, Toyota, Daihatsu
- 20SQ x41MM Hino, Toyota, Daihatsu
- 21SQ x41MM Scania, Isuzu, Hino, Mitsubishi, Nissan

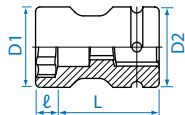
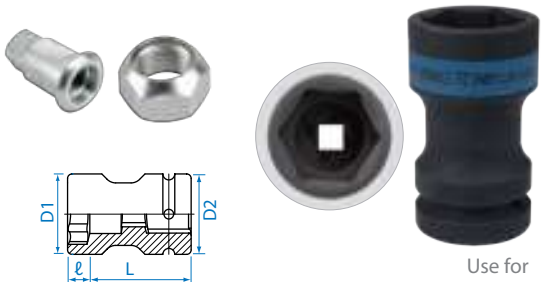

Use for

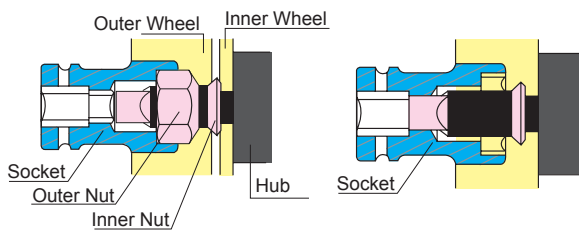

The wheel nut socket fits onto both outer nut and inner nut

KT NO.	SQ	mm	D1 mm	D2 mm	ℓ mm	L mm	g	kg
85451735M	17 x 35		54	54	13	83	857	1 / 24
85451941M	19 x 41		55	54	14	87	924	1 / 24
85452038M	20 x 38		58	54	14	83	796	1 / 24
85452041M	20 x 41		58	54	14	87	1086	1 / 24
85452141M	21 x 41		58	54	14	87	1017	1 / 24

Impact Bit Socket

1954



809622M



- Hex bit & bit holder
- DIN 3121

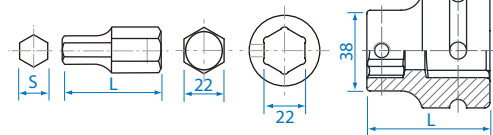

KT NO.	S mm	L mm	Max. torq N·m	g	kg
195419H	H19	54.5	1577	140	12 / 120
195422H	H22	54.5	2436	162	12 / 120
195424H	H24	54.5	2436	176	10 / 100
195427H	H27	54.5	2436	200	10 / 100
195430H	H30	54.5	2436	232	6 / 60
195432H	H32	54.5	2436	243	6 / 60
809622M	22	58.0	-	547	1 / 24

809622MxxH



- Hexagon head
- DIN 3121

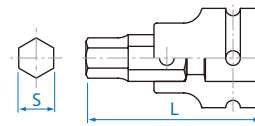
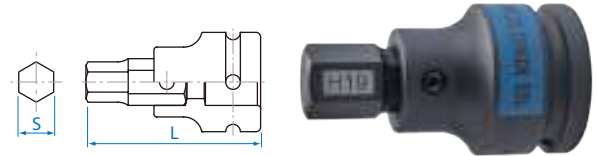

KT NO.	S mm	mm	L (mm)	Max. torq N·m	g	kg
809622M19H	H19	22	93	1577	896	1 / 10
809622M22H	H22	22	93	2436	918	1 / 10
809622M24H	H24	22	93	2436	932	1 / 10
809622M27H	H27	22	93	2436	956	1 / 10
809622M30H	H30	22	93	2436	988	1 / 10
809622M32H	H32	22	93	2436	999	1 / 10



Impact Accessory

8260

- Extension bar
- DIN 3121



8260

8260P

KT NO.	Overall Length		g	g
	Inch	mm		
8260-07	7	175	1400	1 / 12
8260-10	10	250	1932	1 / 12
8260-13	13	330	2458	1 / 8
8260-07P	7	175	1400	1 / 12
8260-10P	10	250	1932	1 / 12
8260-13P	13	330	2458	1 / 8

8797

- Universal joint
- DIN 3121

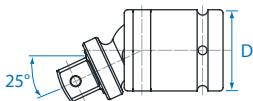

8797P

1"



8797

8797P

KT NO.	Overall Length		D mm	g	g
	Inch	mm			
8797	5	125	60	1491	1 / 18
8797P	5	125	60	1491	1 / 18

8866

- Adapter
- Convert to 3/4" drive
- 8866 → Max. torque : 1412 N·m
- DIN 3121



8866

8866P

KT NO.	Spec.	g	g
8866	1" F x 3/4" M	606	4 / 32
8866P	1" F x 3/4" M	606	4 / 32

8869

- Adapter
- Convert to 1-1/2" drive
- DIN 3121



8869

8869P

KT NO.	Spec.	g	g
8869	1" F x 1-1/2" M	941	1 / 24
8869P	1" F x 1-1/2" M	941	1 / 24

90405

- Locking ring
- High tensile rubber material

90406

1"

90605

- Locking pin
- Chrome vanadium steel
- DIN 3129

90606

1"



90605
90606

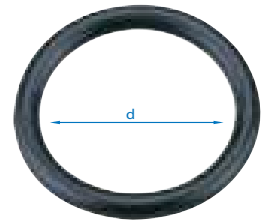

90405
90406

KT NO.	Type	∅	d / l	Applied to socket sizes
90405	ring	5.5	44	8535M (19~70mm) 8535S (3/4"~2-3/4") 8435M (24~60mm) 8435S (15/16"~2-1/4") 8835M (24~60mm)
90605	pin	5.0	45	8514M.8514S.8534M.806519M 8260.8797.8866.8869
90406	ring	10	75	8535M (71~90mm) 8535S (2-13/16"~3-1/2")
90606	pin	5.0	75	

Impact Socket Set

8404MP

1"

Metal case size (mm) :
241 x 124 x 68 (0.51 cuft)



4
PC.

Contents

4.65 1 / 4

8435M 27, 30, 32, 33

8409MP

1"

Metal case size (mm) :
445 x 100 x 65 (0.104 cuft)



8
PC.

Contents

8.9 1 / 2

8435M 24, 27, 30, 32, 33, 36, 38, 41

8408MP

8408MP02 1"

- 6 PC. thin wall deep version
- 2 PC. rear wheel, square

Metal case size (mm) :
445 x 120 x 68 (0.128 cuft)

8
PC.



KT NO. Contents 6.4 1 / 4

8408MP	8835M	24, 27, 32, 36, 38, 41	8534M	17, 21
8408MP02				19, 21

8410MP

8410SP 1"

Metal case size (mm) :
280 x 130 x 74 (0.095 cuft)



8
PC.

KT NO. Contents 6.4 1 / 4

8410MP	8535M	24, 27, 30, 32, 33, 36, 38, 41		
8410SP	8535S	15/16, 1-1/16, 1-3/16, 1-1/4, 1-5/16, 1-7/16, 1-1/2, 1-5/8		

Impact Accessory

9260

9260P 1-1/2"

- Extension bar
- DIN 3121



9260



9260P

KT NO. Overall length

KT NO.	Overall length inch mm		
9260-13	13 330	5900	1 / 4
9260-13P	13 330	5900	1 / 4

9868

9868P 1-1/2"

- Adapter
- Convert to 1" drive
- Max. → torque : 2515 N·m
- DIN 3121



9868



9868P

KT NO. Spec.

KT NO.	Spec.		
9868	1-1/2" F x 1"M	2250	1 / 6
9868P	1-1/2" F x 1"M	2250	1 / 6

Standard Impact Socket

9535M

1-1/2"

▪ DIN 3129

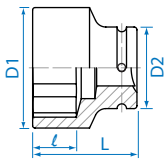

KT NO.	mm	D1 mm	D2 mm	l mm	L mm	Kg	1/6
953532M	32	56	86	23	80	1.393	1 / 6
953533M	33	57	86	23	80	1.952	1 / 6
953534M	34	58	86	24	80	1.923	1 / 6
953536M	36	62	86	26	80	1.994	1 / 6
953538M	38	64	86	26	80	2.001	1 / 6
953541M	41	68	86	28	80	2.056	1 / 6
953542M	42	70	86	28	80	2.081	1 / 6
953546M	46	73	86	30	85	2.154	1 / 6
953550M	50	78	86	32	85	2.246	1 / 6
953555M	55	85	86	36	93	2.520	1 / 6
953560M	60	90	86	40	95	2.757	1 / 6
953565M	65	96	86	42	100	3.134	1 / 6
953570M	70	103	86	46	103	3.529	1 / 6
953575M	75	108	86	48	105	3.713	1 / 4
953580M	80	115	86	52	105	3.934	1 / 4
953585M	85	121	86	55	110	4.467	1 / 4
953590M	90	127	86	58	110	4.652	1 / 4
953595M	95	134	127	50	110	7.224	1 / 1
9535A0M	100	140	127	53	115	7.729	1 / 1
9535A5M	105	146	127	53	115	7.856	1 / 1
9535B0M	110	152	127	56	125	8.845	1 / 1
9535B5M	115	160	127	60	125	9.454	1 / 1
9535C0M	120	166	127	62	130	9.960	1 / 1
9535C5M	125	172	127	65	135	10.826	1 / 1
9535D0M	130	180	127	68	140	12.423	1 / 1
9535D5M	135	185	127	70	145	13.240	1 / 1
9535E0M	140	190	127	75	150	13.570	1 / 1
9535F0M	150	200	127	80	155	14.270	1 / 1

9535S

1-1/2"

▪ ANSI / ASME B107.1

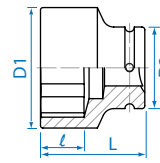

KT NO.	inch	D1 mm	D2 mm	l mm	L mm	Kg	1/6
953564S	2	81	86	35	85	2.305	1 / 6
953566S	2-1/16	82	86	36	85	2.364	1 / 6
953568S	2-1/8	84	86	36	90	2.508	1 / 6
953570S	2-3/16	85	86	43	93	3.204	1 / 6
953572S	2-1/4	87	86	43	93	5.209	1 / 6
953574S	2-5/16	89	86	43	93	2.560	1 / 6
953576S	2-3/8	90	86	45	95	2.622	1 / 6
953578S	2-7/16	93	86	44	95	2.711	1 / 6
953580S	2-1/2	95	86	46	97	2.833	1 / 6
953582S	2-9/16	96	86	49	100	2.863	1 / 6
953584S	2-5/8	99	86	48	100	2.958	1 / 6
953586S	2-11/16	101	86	48	100	3.055	1 / 6
953588S	2-3/4	103	86	48	103	3.217	1 / 6
953590S	2-13/16	105	86	50	105	3.306	1 / 6
953592S	2-7/8	107	86	50	105	3.600	1 / 6
953594S	2-15/16	108	86	50	105	3.455	1 / 6
953596S	3	111	86	50	105	3.590	1 / 4
953598S	3-1/16	114	86	52	105	3.931	1 / 4
9535A0S	3-1/8	116	86	53	105	4.123	1 / 4
9535A2S	3-3/16	118	86	53	105	4.089	1 / 4
9535A4S	3-1/4	120	86	54	105	4.829	1 / 4
9535A6S	3-5/16	122	86	56	105	4.207	1 / 4
9535A8S	3-3/8	123	86	56	105	4.306	1 / 4
9535B0S	3-7/16	125	86	57	105	4.256	1 / 4
9535B2S	3-1/2	129	86	60	110	4.905	1 / 4
9535B4S	3-9/16	130	86	60	110	5.435	1 / 4
9535B6S	3-5/8	131	86	60	110	4.894	1 / 4
9535B8S	3-11/16	133	86	62	113	5.468	1 / 1
9535C0S	3-3/4	136	127	62	113	3.741	1 / 1
9535C2S	3-13/16	138	127	64	120	9.098	1 / 1
9535C4S	3-7/8	139	127	66	120	8.954	1 / 1
9535C6S	3-15/16	140	127	66	120	8.931	1 / 1
9535C8S	4	142	127	66	120	7.886	1 / 1
9535D0S	4-1/16	143	127	68	120	7.843	1 / 1
9535D2S	4-1/8	146	127	68	120	8.003	1 / 1
9535D4S	4-3/16	146	127	70	120	7.851	1 / 1
9535D6S	4-1/4	150	127	72	124	8.385	1 / 1
9535D8S	4-5/16	154	127	72	124	8.973	1 / 1
9535E0S	4-3/8	155	127	72	124	8.923	1 / 1
9535E2S	4-7/16	155	127	75	128	9.033	1 / 1
9535E4S	4-1/2	159	127	75	128	9.258	1 / 1
9535E8S	4-5/8	164	127	79	132	13.730	1 / 1
9535F2S	4-3/4	167	127	79	132	10.386	1 / 1
9535F6S	4-7/8	171	127	79	136	10.930	1 / 1
9535G0S	5	174	127	79	140	11.338	1 / 1
9535G4S	5-1/8	180	127	80	143	12.279	1 / 1
9535G8S	5-1/4	184	127	80	145	12.728	1 / 1
9535J2S	6	203	127	85	165	14.270	1 / 1



Standard Impact Socket

A535M

○ 2-1/2"

▪ DIN 3129

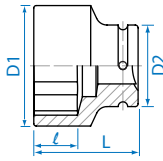

A535S

○ 2-1/2"

▪ ANSI / ASME B107.1

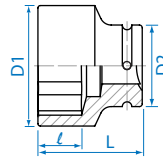

KT NO.	mm	D1 mm	D2 mm	ℓ mm	L mm	Kg	Box
A535041M	41	78	127	39	115	5.98	1 / 4
A535046M	46	83	127	39	115	5.97	1 / 4
A535050M	50	88	127	39	115	6.05	1 / 4
A535051M	51	89	127	39	115	6.06	1 / 4
A535055M	55	94	127	42	115	6.14	1 / 4
A535057M	57	96	127	42	115	6.18	1 / 4
A535060M	60	100	127	45	125	6.87	1 / 2
A535065M	65	105	127	48	125	6.90	1 / 2
A535070M	70	110	127	50	125	6.93	1 / 2
A535075M	75	115	127	55	125	7.14	1 / 2
A535076M	76	120	127	55	125	7.14	1 / 2
A535077M	77	120	127	55	125	7.15	1 / 2
A535080M	80	123	127	57	125	7.22	1 / 2
A535085M	85	127	127	60	130	7.54	1 / 2
A535086M	86	127	127	60	130	7.47	1 / 2
A535090M	90	135	127	65	130	7.90	1 / 2
A535095M	95	140	127	70	140	8.61	1 / 2
A535100M	100	145	127	70	140	8.81	1 / 2
A535105M	105	155	127	70	142	10.18	1 / 2
A535110M	110	160	127	76	155	11.50	1 / 2
A535115M	115	165	127	78	155	18.39	1 / 2
A535120M	120	175	127	80	160	13.18	1 / 1
A535125M	125	180	127	82	165	19.87	1 / 1
A535130M	130	185	127	85	170	20.64	1 / 1
A535135M	135	190	127	90	175	21.75	1 / 1
A535140M	140	200	127	95	180	24.06	1 / 1
A535145M	145	205	127	95	183	24.96	1 / 1
A535150M	150	210	127	100	190	26.91	1 / 1
A535155M	155	215	175	100	195	27.99	1 / 1
A535160M	160	225	175	100	200	31.13	1 / 1
A535165M	165	230	175	105	205	32.45	1 / 1
A535170M	170	235	175	105	205	33.15	1 / 1
A535175M	175	240	175	110	210	34.52	1 / 1
A535180M	180	250	175	110	213	38.23	1 / 1
A535185M	185	255	175	110	213	39.84	1 / 1
A535190M	190	265	175	115	220	41.49	1 / 1
A535200M	200	275	175	120	225	44.44	1 / 1
A535210M	210	285	175	125	235	48.78	1 / 1
A535215M	215	290	175	125	240	51.21	1 / 1
A535225M	225	305	175	135	250	57.57	1 / 1
A535235M	235	315	175	140	260	62.92	1 / 1

(Make - to - order production)

KT NO.	inch	D1 mm	D2 mm	ℓ mm	L mm	Kg	Box
A535076S	2-3/8	100	127	45	125	6.89	1 / 2
A535078S	2-7/16	103	127	45	125	6.93	1 / 2
A535080S	2-1/2	103	127	48	125	6.85	1 / 2
A535082S	2-9/16	105	127	48	125	6.90	1 / 2
A535084S	2-5/8	107	127	50	125	6.94	1 / 2
A535088S	2-3/4	110	127	50	125	6.93	1 / 2
A535090S	2-13/16	115	127	50	125	7.04	1 / 2
A535094S	2-15/16	115	127	55	125	7.16	1 / 2
A535096S	3	120	127	55	125	7.20	1 / 2
A535100S	3-1/8	123	127	57	125	7.26	1 / 2
A535108S	3-3/8	127	127	60	130	7.48	1 / 2
A535112S	3-1/2	135	127	65	130	7.98	1 / 2
A535120S	3-3/4	140	127	70	140	8.56	1 / 2
A535124S	3-7/8	145	127	70	140	8.65	1 / 2
A535126S	3-15/16	145	127	70	140	8.76	1 / 2
A535132S	4-1/8	155	127	70	142	9.91	1 / 2
A535136S	4-1/4	160	127	75	155	11.74	1 / 2
A535138S	4-5/16	160	127	75	155	12.52	1 / 2
A535144S	4-1/2	165	127	78	155	12.61	1 / 2
A535148S	4-5/8	175	127	80	160	19.18	1 / 1
A535156S	4-7/8	180	127	82	165	19.87	1 / 1
A535160S	5	185	127	82	165	20.02	1 / 1
A535164S	5-1/8	185	127	85	170	20.42	1 / 1
A535168S	5-1/4	190	127	90	175	21.81	1 / 1
A535172S	5-3/8	200	127	95	180	23.90	1 / 1
A535180S	5-5/8	205	127	95	183	24.43	1 / 1
A535184S	5-3/4	205	127	95	183	26.30	1 / 1
A535188S	5-7/8	210	127	100	190	26.62	1 / 1
A535192S	6	215	175	100	195	29.10	1 / 1
A535196S	6-1/8	220	175	100	195	28.69	1 / 1
A535200S	6-1/4	220	175	100	195	28.58	1 / 1
A535204S	6-3/8	225	175	100	200	30.77	1 / 1
A535208S	6-1/2	230	175	105	205	31.05	1 / 1
A535212S	6-5/8	235	175	105	205	32.17	1 / 1
A535216S	6-3/4	235	175	105	205	33.68	1 / 1
A535220S	6-7/8	240	175	110	210	32.41	1 / 1
A535224S	7	245	175	110	210	35.53	1 / 1
A535240S	7-1/2	265	175	115	220	41.16	1 / 1
A535244S	7-5/8	265	175	115	220	41.52	1 / 1
A535252S	7-7/8	275	175	120	225	44.46	1 / 1
A535256S	8	280	175	120	230	45.89	1 / 1

(Make - to - order production)

Standard Impact Socket

B535M

3-1/2"

▪ DIN 3129

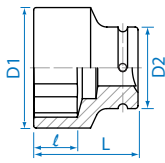

B535S

3-1/2"

▪ ANSI / ASME B107.1

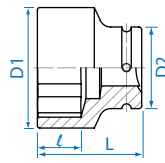

KT NO.	mm	D1 mm	D2 mm	l mm	L mm	kg	1/1
B535105M	105	165	175	70	175	18.73	1 / 1
B535110M	110	170	175	75	175	19.19	1 / 1
B535115M	115	175	175	78	180	19.74	1 / 1
B535120M	120	180	175	80	185	20.24	1 / 1
B535125M	125	185	175	82	185	21.86	1 / 1
B535130M	130	190	175	85	194	22.70	1 / 1
B535135M	135	200	175	90	200	24.24	1 / 1
B535140M	140	205	175	95	205	25.59	1 / 1
B535145M	145	210	175	95	210	31.12	1 / 1
B535150M	150	215	175	100	210	32.38	1 / 1
B535160M	160	230	175	100	220	35.85	1 / 1
B535165M	165	235	175	105	224	37.92	1 / 1
B535170M	170	240	175	105	225	38.71	1 / 1
B535175M	175	245	175	110	230	40.05	1 / 1
B535180M	180	255	200	110	230	43.77	1 / 1
B535185M	185	260	200	110	235	46.94	1 / 1
B535190M	190	270	200	115	240	50.60	1 / 1
B535200M	200	280	200	120	245	52.90	1 / 1
B535210M	210	290	200	125	250	57.50	1 / 1
B535215M	215	300	200	125	250	60.06	1 / 1
B535225M	225	310	200	135	265	61.50	1 / 1
B535235M	235	315	200	140	267	67.91	1 / 1

(Make - to - order production)

KT NO.	inch	D1 mm	D2 mm	l mm	L mm	kg	1/1
B535132S	4-1/8	165	175	70	175	18.74	1 / 1
B535136S	4-1/4	168	175	75	175	19.08	1 / 1
B535140S	4-3/8	170	175	75	175	19.74	1 / 1
B535144S	4-1/2	175	175	78	180	19.72	1 / 1
B535148S	4-5/8	175	175	80	180	19.95	1 / 1
B535152S	4-3/4	180	175	80	185	20.14	1 / 1
B535156S	4-7/8	185	175	82	185	22.04	1 / 1
B535160S	5	190	175	82	194	21.59	1 / 1
B535164S	5-1/8	190	175	85	194	22.64	1 / 1
B535168S	5-1/4	200	175	90	200	23.59	1 / 1
B535172S	5-3/8	200	175	95	200	24.64	1 / 1
B535176S	5-1/2	205	175	95	205	25.57	1 / 1
B535180S	5-5/8	205	175	95	205	30.53	1 / 1
B535184S	5-3/4	210	175	95	210	31.92	1 / 1
B535188S	5-7/8	215	175	100	210	32.50	1 / 1
B535192S	6	220	175	100	215	33.43	1 / 1
B535196S	6-1/8	220	175	100	215	34.28	1 / 1
B535200S	6-1/4	230	175	100	220	35.13	1 / 1
B535204S	6-3/8	230	175	100	220	36.51	1 / 1
B535208S	6-1/2	235	175	105	224	37.76	1 / 1
B535212S	6-5/8	235	175	105	224	37.98	1 / 1
B535216S	6-3/4	240	175	105	225	38.70	1 / 1
B535220S	6-7/8	245	175	110	230	39.87	1 / 1
B535224S	7	250	200	110	230	41.99	1 / 1
B535228S	7-1/8	255	200	110	230	44.24	1 / 1
B535232S	7-1/4	260	200	110	235	46.61	1 / 1
B535236S	7-3/8	270	200	115	240	48.11	1 / 1
B535240S	7-1/2	270	200	115	240	50.65	1 / 1
B535244S	7-5/8	275	200	115	240	51.49	1 / 1
B535248S	7-3/4	280	200	120	245	52.11	1 / 1
B535252S	7-7/8	280	200	120	245	53.59	1 / 1
B535256S	8	285	200	120	245	55.59	1 / 1
B535260S	8-1/8	290	200	120	250	56.25	1 / 1
B535264S	8-1/4	290	200	125	250	57.50	1 / 1
B535268S	8-3/8	300	200	125	250	59.14	1 / 1
B535272S	8-1/2	300	200	125	250	59.43	1 / 1
B535276S	8-5/8	305	200	135	260	61.94	1 / 1
B535280S	8-3/4	310	200	135	265	64.58	1 / 1
B535284S	8-7/8	315	200	140	267	66.14	1 / 1

(Make - to - order production)



PNEUMATIC TOOLS

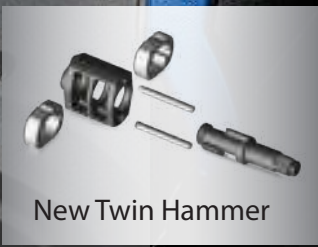

New Twin Hammer

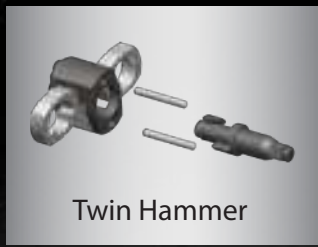

Twin Hammer



Jumbo Hammer

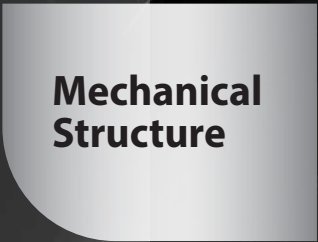

Mechanical Structure



Twin Dog



Pinless Hammer



What you need to know

Air supply system :

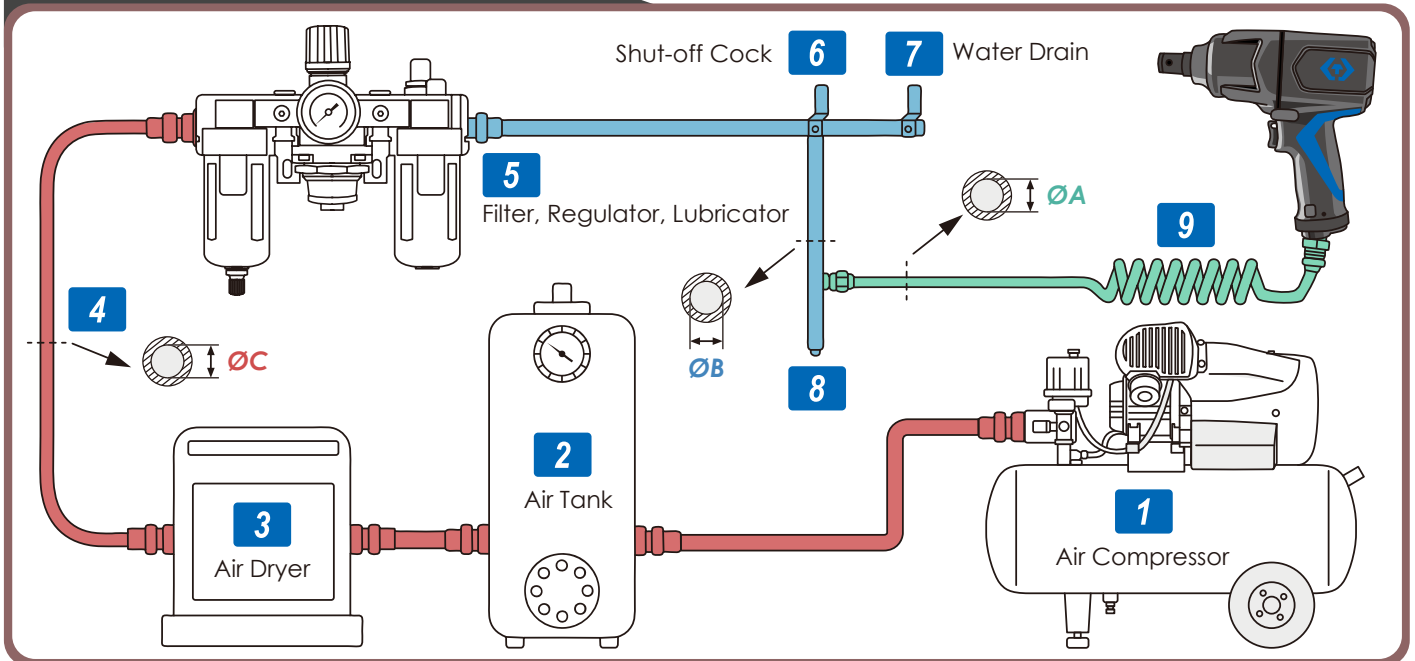

Piping diameters and length requirement :

$\varnothing A$ = Follow air tools specification table, length should be less than 4.5m.

$\varnothing B$ = 2 times tools hose size. ($\varnothing B = 2x\varnothing A$)

$\varnothing C$ = 3 times tools hose size. ($\varnothing C = 3x\varnothing A$)



Preparation

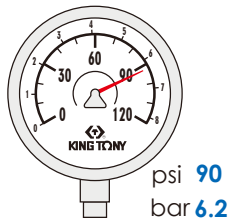

• Set the air pressure

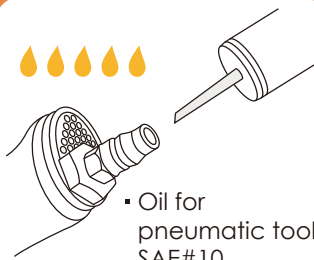



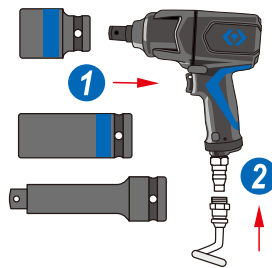



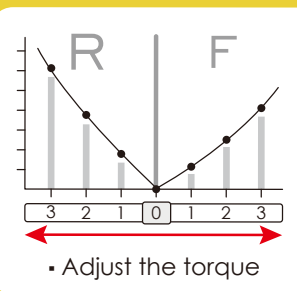
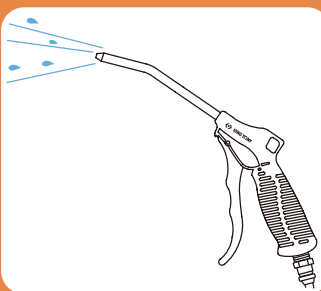
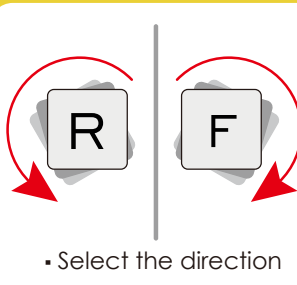
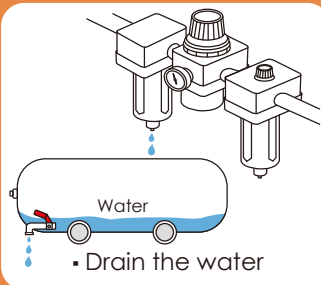
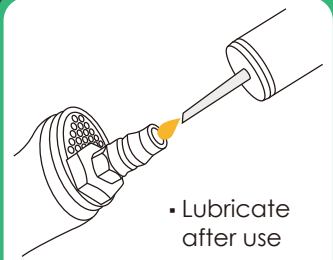

































































































Operation



Maintenance



KT NO.	Drive	Max. torque		Type			Working place	Anvil		Page
		ft-lb	N-m	Standard	Lightweight	Mini.		STD	Long	
33491-030 33491-031	1/2" 	300	407				   	○		269
33431-050 33431-051		500	678				   	○		270
33411-040 33411-041		500	678				 	○		271
33421-040 33421-041		500	678				 	○		271
33411-050 33411-051		650	881				 	○		271
33412-050 33412-051		650	881				 		②	271
33431-065		650	881				  	○		272
33461-100 33461-101		1000	1356				  	○		268
33481-095 33481-096		950	1288				  	○		273
33611-055 33611-056		3/4" 	700	949				 	○	
33621-075 33621-076	800		1085				 	○		272
33622-075 33622-076	800		1085				 		⑥	272
33681-100 33681-101	1100		1491				  	○		273
33631-110 33631-111	1100		1491				  	○		273
33632-110 33632-111	1100		1491				  		⑥	273
33671-160 33672-160	1600		2170				   	○	⑥	275
33851-120 33851-121	1200		1626				   	○		274
33852-120 33852-121	1200		1626				  		⑥	274
33811-150 33812-150	1500		2033				  	○	⑥	276
33871-160 33872-160	1600	2170				  	○	⑥	275	
33841-180 33842-180	1800	2440				  	○	⑥	274	
33831-180 33832-180	1800	2440				  	○	⑥	276	
33861-200 33862-200	2000	2712				  	○	⑥	277	
33851-250 33852-250	2500	3388				 	○	⑧	278	
33911-250 33912-250	1-1/2" 	2500	3388				   	○	⑧	278
33921-300 33922-300		3000	4065				   	○	⑧	278

1/2" DR. Super Duty Composite Impact Wrench



PNEUMATIC TOOLS



CAUTION Please wear proper safety gear while working.



33461-100

33461-101



- TPR ergonomic handle material reduces vibration



- 3-speed power setting, full speed in reverse



1/2"
33461

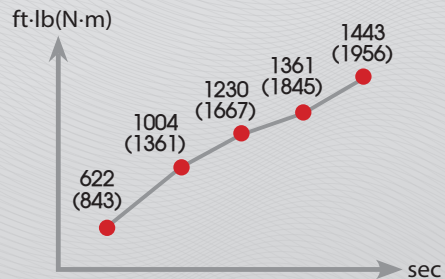

KT NO.	Square drive Inch mm	Std. bolt size Inch mm	Free speed R.P.M	Max. torque ft-lb N-m	Overall length Inch mm	Air inlet Inch	Air hose ID	Air pressure bar psi	Avg. air consumption L/min CFM	Sound DBA	Vib M/S2	Net weight kgs lbs	
33461-100	1/2" 12.70	1" M24	9500	1000 1356	7.5 190	1/4" BSPT	3/8"	6.2 90	207 7.3	99.2	13.32	2.30 5.28	1 / 8
33461-101	1/2" 12.70	1" M24	9500	1000 1356	7.5 190	1/4" NPT	3/8"	6.2 90	207 7.3	99.2	13.32	2.30 5.28	1 / 8

Ultra Compact Angle Impact Wrench

33491-030



- Easy to work in confined space, head length 88mm
- Ergonomic handle in hand and great power setting
- Lightweight : 1.4Kg
- Max. torque : 350ft-lb (475N-m) in reverse



1/2"
33491



- 3-speed power setting
3 2 1
- Full speed in reverse
3



- 360° swivel exhaust deflector



- Gearless hammer design
Reduces vibration by 50%,
Increases torque by 20%

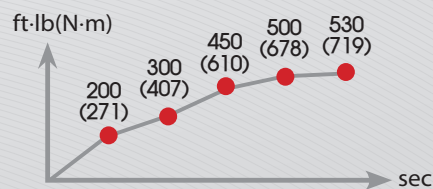

KT NO.	Square drive Inch mm	Std. bolt size Inch mm	Free speed R.P.M	Max. torque ft-lb N-m	Overall length Inch mm	Air Inlet Inch	Air hose ID	Air pressure bar psi	Avg. air consumption L/min CFM	Sound DBA	Vib M/S2	Net weight kgs lbs	
33491-030	1/2" 12.70	9/16" M14	6,500	300 407	9-64/49" 248	1/4"BSPT	3/8"	6.2 90	119 4.2	94.00	7.48	1.40 3.09	1/12
33491-031	1/2" 12.70	9/16" M14	6,500	300 407	9-64/49" 248	1/4"NPT	3/8"	6.2 90	119 4.2	94.00	7.48	1.40 3.09	1/12

Mini Impact Wrench

33431-050



- Mini design, overall length 109mm with 1.35kg
- Nickel chrome molybdenum square drive
- Improved jumbo hammer design : 30% higher torque
- One hand operation



1/2"
33431



- One-hand control forward & reverse switch



- Convenient to switch on both sides

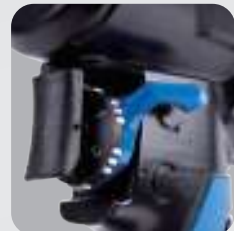

- 3-speed regulator for precise control



- Ergonomic design interchangeable rubber grip

-15% length

- 360 rotation air inlet connector design



- Air exhaust away from the operator

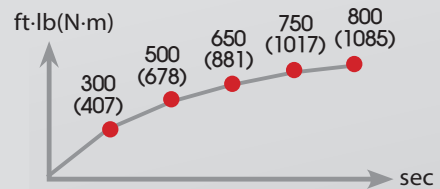

KT NO.	Square drive inch mm	Type Std/Long anvil	Std. bolt size inch mm	Free speed R.P.M	Max. torque ft-lb N-m	Overall length inch mm	Air inlet inch	Air hose ID	Air pressure bar psi	Avg. air consumption L/min CFM	Sound DBA	Vib. M/S2	Net weight kgs lbs
33431-050	1/2" 12.70	Std.anvil	5/8" M16	9000	500 678	4-19/64" 109	1/4"BSPT	3/8"	6.2 90	142 5.0	101.02	8.70	1.35 2.98 1 / 12
33431-051	1/2" 12.70	Std.anvil	5/8" M16	9000	500 678	4-19/64" 109	1/4"NPT	3/8"	6.2 90	142 5.0	101.02	8.70	1.35 2.98 1 / 12

Impact Wrench

33421

- Nickel chrome molybdenum square drive
- Variable speed trigger
- Muffled on front exhaust

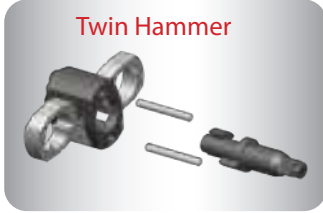

33421

KT NO.	Square drive inch mm	Type Std./Long anvil	Std. bolt size inch mm	Free speed R.P.M.	Max. torque ft-lb N-m	Overall length inch mm	Air inlet inch	Air hose ID	Air pressure bar psi	Avg. air consumption L/min CFM	Sound DBA	Vib M/S ²	Net weight kgs lbs
33421-040	1/2" 12.70	Std. anvil	5/8" M16	8000	500 678	6-3/4" 171	1/4" BSPT	3/8"	6.2 90	113 4.0	101.02	8.70	2.56 5.64 1 / 8
33421-041	1/2" 12.70	Std. anvil	5/8" M16	8000	500 678	6-3/4" 171	1/4" NPT	3/8"	6.2 90	113 4.0	101.02	8.70	2.56 5.64 1 / 8

33411-040

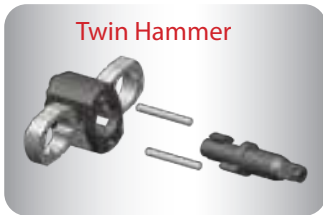

33411-040

33411-050 / 33412-050



33411-050



33412-050

KT NO.	Square drive inch mm	Type Std./Long anvil	Std. bolt size inch mm	Free speed R.P.M.	Max. torque ft-lb N-m	Overall length inch mm	Air inlet inch	Air hose ID	Air pressure bar psi	Avg. air consumption L/min CFM	Sound DBA	Vib M/S ²	Net weight kgs lbs
33411-040	1/2" 12.70	Std. anvil	5/8" M16	8000	500 678	7-23/64" 187	1/4" BSPT	3/8"	6.2 90	113 4.0	95.22	4.85	2.60 5.73 1 / 8
33411-041	1/2" 12.70	Std. anvil	5/8" M16	8000	500 678	7-23/64" 187	1/4" NPT	3/8"	6.2 90	113 4.0	95.22	4.85	2.60 5.73 1 / 8
33411-050	1/2" 12.70	Std. anvil	3/4" M19	8000	650 881	7-41/64" 194	1/4" BSPT	3/8"	6.2 90	125 4.4	96.50	8.13	2.80 6.17 1 / 8
33411-051	1/2" 12.70	Std. anvil	3/4" M19	8000	650 881	7-41/64" 194	1/4" NPT	3/8"	6.2 90	125 4.4	96.50	8.13	2.80 6.17 1 / 8
33412-050	1/2" 12.70	Long anvil	3/4" M19	8000	650 881	9-23/64" 238	1/4" BSPT	3/8"	6.2 90	125 4.4	96.19	6.84	3.20 7.05 1 / 8
33412-051	1/2" 12.70	Long anvil	3/4" M19	8000	650 881	9-23/64" 238	1/4" NPT	3/8"	6.2 90	125 4.4	96.19	6.84	3.20 7.05 1 / 8

Impact Wrench



33431

- One-handed F / R control
- Convenient to switch on both sides
- 3-speed regulator for precise control
- Ergonomic design interchangeable rubber grip

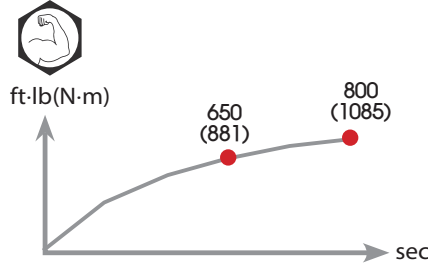
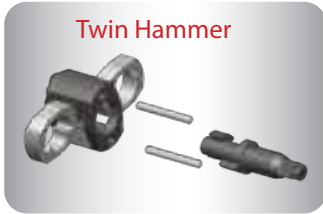

KT NO.	Square drive Inch mm	Type Std/Long anvil	Std. bolt size Inch mm	Free speed R.P.M	Max. torque ft-lb N-m	Overall length Inch mm	Air inlet Inch	Air hose ID	Air pressure bar psi	Avg. air consumption L/min CFM	Sound DBA	Vib M/S ²	Net weight kgs lbs
33431-065	1/2" 12.70	Std.anvil	3/4" M19	8000	650 881	6-7/8" 175	1/4"BSPT	3/8"	6.2 90	139 4.9	101.50	9.37	2.58 5.69 1 / 8

33611

- Nickel chrome molybdenum square drive
- Variable speed trigger
- Muffled on handle exhaust



33621 / 33622



KT NO.	Square drive Inch mm	Type Std/Long anvil	Std. bolt size Inch mm	Free speed R.P.M	Max. torque ft-lb N-m	Overall length Inch mm	Air inlet Inch	Air hose ID	Air pressure bar psi	Avg. air consumption L/min CFM	Sound DBA	Vib M/S ²	Net weight kgs lbs
33611-055	3/4" 19.05	Std. anvil	7/8" M20	6500	700 949	7-13/32" 188	1/4"BSPT	3/8"	6.2 90	125 4.4	96.56	8.64 3.00	6.61 1 / 8
33611-056	3/4" 19.05	Std. anvil	7/8" M20	6500	700 949	7-13/32" 188	1/4"NPT	3/8"	6.2 90	125 4.4	96.56	8.64 3.00	6.61 1 / 8
33621-075	3/4" 19.05	Std. anvil	1" M24	6500	800 1085	8-63/64" 228	1/4"BSPT	3/8"	6.2 90	198 7.0	97.28	6.89 4.50	9.92 1 / 4
33621-076	3/4" 19.05	Std. anvil	1" M24	6500	800 1085	8-63/64" 228	1/4"NPT	3/8"	6.2 90	198 7.0	97.28	6.89 4.50	9.92 1 / 4
33622-075	3/4" 19.05	Long anvil	1" M24	6500	800 1085	12-63/64" 330	1/4"BSPT	3/8"	6.2 90	198 7.0	96.68	6.46 5.00	11.02 1 / 4
33622-076	3/4" 19.05	Long anvil	1" M24	6500	800 1085	12-63/64" 330	1/4"NPT	3/8"	6.2 90	198 7.0	96.68	6.46 5.00	11.02 1 / 4

Composite Impact Wrench



33481

- One-handed F / R control
- 4-speed power setting, full speed in reverse
- TPR ergonomic handle material reduces vibration



lightweight
20% - 48%

33681



33481



33681

KT NO.	Square drive		Type Std./Long anvil	Std. bolt size		Free speed R.P.M No	Max. torque		Overall length		Air inlet inch	Air hose ID	Air pressure		Avg. air consumption L/min CFM	Sound DBA	Vib M/S2	Net weight			
	inch	mm		inch	mm		ft-lb	N-m	inch	mm			bar	psi				kgs	lbs	in	
33481-095	1/2"	12.70	Std.anvil	1"	M24	8000	950	1288	7-3/4"	197	1/4"BSPT	3/8"	6.2	90	190	6.7	96.00	8.10	2.25	4.96	1 / 8
33481-096	1/2"	12.70	Std.anvil	1"	M24	8000	950	1288	7-3/4"	197	1/4"NPT	3/8"	6.2	90	190	6.7	96.00	8.10	2.25	4.96	1 / 8
33681-100	3/4"	19.05	Std.anvil	1-3/16"	M30	8000	1100	1491	8-3/8"	211	1/4"BSPT	3/8"	6.2	90	190	6.7	96.00	8.98	2.35	5.20	1 / 8
33681-101	3/4"	19.05	Std.anvil	1-3/16"	M30	8000	1100	1491	8-3/8"	211	1/4"NPT	3/8"	6.2	90	190	6.7	96.00	8.98	2.35	5.20	1 / 8

33631 / 33632

- Nickel chrome molybdenum square drive
- Variable speed trigger
- Muffled on handle exhaust



KT NO.	Square drive		Type Std./Long anvil	Std. Bolt Size		Free Speed R.P.M No	Max. Torque		Overall Length		Air inlet inch	Air Hose ID	Air Pressure		Avg. Air Consumption L/min CFM	Sound DBA	Vib M/S2	Net Weight			
	inch	mm		inch	mm		ft-lb	N-m	inch	mm			bar	psi				kgs	lbs	in	
33631-110	3/4"	19.05	Std. anvil	1-3/16"	M30	5500	1100	1491	8-43/64"	220	3/8"BSPT	1/2"	6.2	90	269	9.5	98.35	5.31	5.60	12.35	1 / 4
33631-111	3/4"	19.05	Std. anvil	1-3/16"	M30	5500	1100	1491	8-43/64"	220	3/8"NPT	1/2"	6.2	90	269	9.5	98.35	5.31	5.60	12.35	1 / 4
33632-110	3/4"	19.05	Long anvil	1-3/16"	M30	5500	1100	1491	14-55/64"	377	3/8"BSPT	1/2"	6.2	90	269	9.5	97.20	7.90	6.04	13.32	1 / 4
33632-111	3/4"	19.05	Long anvil	1-3/16"	M30	5500	1100	1491	14-55/64"	377	3/8"NPT	1/2"	6.2	90	269	9.5	97.20	7.90	6.04	13.32	1 / 4

Impact Wrench

33851 / 33852

- Nickel chrome molybdenum square drive
- Variable speed trigger
- Muffled on handle exhaust

New Twin Hammer



33841 / 33842



1"
33851



1"
33841



1"
33852



1"
33842



KT NO.	Square drive inch mm	Type Std/Long anvil	Std. bolt size inch mm	Free speed R.P.M	Max. torque ft-lb N-m	Overall length inch mm	Air inlet inch	Air hose ID	Air pressure bar psi	Avg. air consumption l/min CFM	Sound DBA	Vib M/S ²	Net weight kgs lbs	
33851-120	1" 25.40	Std. anvil	1-17/64" M32	5500	1200 1626	8-53/64" 224	3/8"BSPT	1/2"	6.2 90	269 9.5	99.75	6.57	5.64 12.43	1 / 4
33851-121	1" 25.40	Std. anvil	1-17/64" M32	5500	1200 1626	8-53/64" 224	3/8"NPT	1/2"	6.2 90	269 9.5	99.75	6.57	5.64 12.43	1 / 4
33852-120	1" 25.40	Long anvil	1-17/64" M32	5500	1200 1626	14-1/64" 356	3/8"BSPT	1/2"	6.2 90	269 9.5	98.00	8.40	6.04 13.32	1 / 4
33852-121	1" 25.40	Long anvil	1-17/64" M32	5500	1200 1626	14-1/64" 356	3/8"NPT	1/2"	6.2 90	269 9.5	98.00	8.40	6.04 13.32	1 / 4
33841-180	1" 25.40	Std. anvil	1-27/64" M36	4000	1800 2440	12-3/32" 307	1/2" BSPT / NPT	3/4"	6.2 90	255 9.0	101.56	4.37	10.62 23.41	1 / 2
33842-180	1" 25.40	Long anvil	1-27/64" M36	4000	1800 2440	20-5/64" 510	1/2" BSPT / NPT	3/4"	6.2 90	255 9.0	99.85	5.87	12.52 27.60	1 / 2

Impact Wrench

33671 / 33672

- Lightweight durable composite housing
- Nickel chrome molybenum square drive
- Comfortable rubber handle

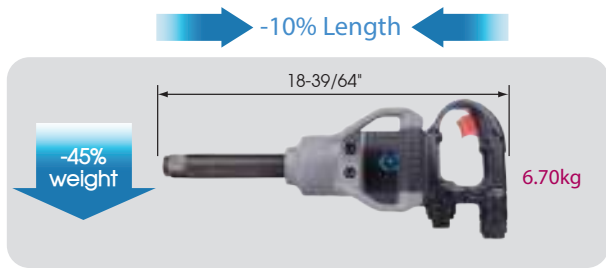
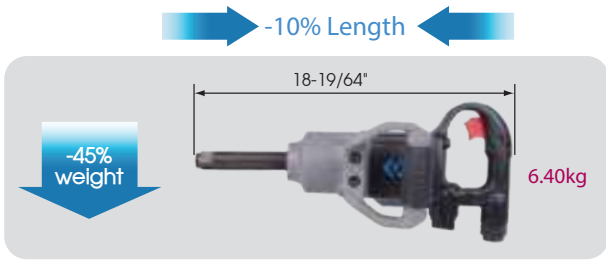
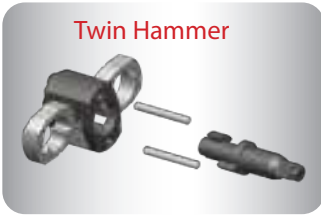

33871 / 33872



KT NO.	Square drive inch mm	Type Std./Long anvil	Std. Bolt Size inch mm	Free Speed R.P.M	Max. Torque ft-lb N-m	Overall Length inch mm	Air Inlet inch	Air Hose ID	Air Pressure bar psi	Avg. Air Consumption L/min CFM	Sound DBA	Vib. M/S ²	Net Weight kgs lbs	
33671-160	3/4" 19.05	Std. anvil	1-3/16" M30	5500	1600 2170	12-1/2" 318	1/2" BSPT / NPT	3/4"	6.2 90	241 8.5	105.00	15.40	5.70 12.57	1 / 2
33672-160	3/4" 19.05	Long anvil	1-3/16" M30	5500	1600 2170	18-19/64" 465	1/2" BSPT / NPT	3/4"	6.2 90	241 8.5	106.00	13.80	6.40 14.11	1 / 2
33871-160	1" 25.40	Std. anvil	1-3/16" M30	5500	1600 2170	12-45/64" 323	1/2" BSPT / NPT	3/4"	6.2 90	241 8.5	106.00	13.70	5.80 12.79	1 / 2
33872-160	1" 25.40	Long anvil	1-3/16" M30	5500	1600 2170	18-39/64" 473	1/2" BSPT / NPT	3/4"	6.2 90	241 8.5	104.00	14.98	6.70 14.77	1 / 2



PNEUMATIC TOOLS

Impact Wrench

33811 / 33812

- Nickel chrome molybdenum square drive
- Variable speed trigger
- Muffled on handle exhaust

33831 / 33832



New Twin Hammer



33811-150



33812-150



33831-180



33832-180



KT NO.	Square drive		Type Std/Long anvil	Std. Bolt Size		Free Speed R.P.M	Max. Torque		Overall Length		Air Inlet Inch	Air Hose ID	Air Pressure		Avg. Air Consumption L/min CFM	Sound DBA	Vib M/S2	Net Weight			
	inch	mm		inch	mm		ft.-lb	N-m	inch	mm			bar	psi				kgs	lbs		
33811-150	1"	25.40	Std. anvil	1-1/4"	M36	4000	1500	2033	14-19/32"	371	1/2" BSPT / NPT	3/4"	6.2	90	255	9.0	101.17	10.77	10.30	22.71	1 / 1
33812-150	1"	25.40	Long anvil	1-1/4"	M36	4000	1500	2033	20-19/32"	523	1/2" BSPT / NPT	3/4"	6.2	90	255	9.0	100.40	6.13	11.30	24.91	1 / 1
33831-180	1"	25.40	Std. anvil	1-1/2"	M38	4000	1800	2440	14-19/32"	371	1/2" BSPT / NPT	3/4"	6.2	90	255	9.0	102.11	8.84	11.50	25.35	1 / 1
33832-180	1"	25.40	Long anvil	1-1/2"	M38	4000	1800	2440	20-19/32"	523	1/2" BSPT / NPT	3/4"	6.2	90	255	9.0	103.99	6.60	12.50	27.56	1 / 1

Impact Wrench

33861 / 33862

- Light weight durable composite housing
- Nickel chrome molybdenum square drive
- Comfortable rubber handle

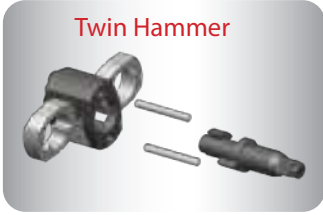

Twin Hammer

→ -10% Length ←

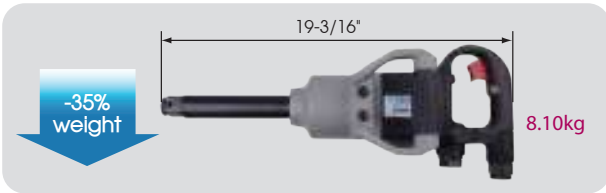

-35% weight

8.10kg



33861-200



33862-200



KT NO.	Square drive inch mm	Type Std./Long anvil	Std. bolt size inch mm	Free speed R.P.M	Max. torque ft-lb N-m	Overall length inch mm	Air inlet inch	Air hose ID	Air pressure bar psi	Avg. air consumption L/min CFM	Sound DBA	Vib. M/S ²	Net weight kgs lbs	
33861-200	1"	25.40 Std. anvil	1-27/64" M36	5000	2000 2712	13-43/64" 347	1/2" BSPT / NPT	3/4"	6.2 90	255 9.0	106.00	17.20	7.40 16.31	1 / 2
33862-200	1"	25.40 Long anvil	1-27/64" M36	5000	2000 2712	19-3/16" 487	1/2" BSPT / NPT	3/4"	6.2 90	255 9.0	104.00	14.50	8.10 17.86	1 / 2



Impact Wrench

33851 / 33852

33911 / 33912

33921 / 33922

- Nickel chrome molybdenum square drive
- Variable speed trigger
- Muffled on handle exhaust



New Twin Hammer



1"
 33851-250



1"
 33852-250



1-1/2"
 33911-250
33921-300



1-1/2"
 33912-250
33922-300



KT NO.	Square drive inch mm	Type Std./Long anvil	Std. Bolt Size inch mm	Free Speed R.P.M	Max. Torque ft.-lb N-m	Overall Length inch mm	Air Inlet inch	Air Hose ID	Air Pressure bar psi	Avg. Air Consumption L/min CFM	Sound DBA	Vib M/S ²	Net Weight kgs lbs	
33851-250	1" 25.40	Std. anvil	1-25/32" M45	3000	2500 3388	17-11/64" 436	1/2" BSPT / NPT	3/4"	6.2 90	411 14.5	101.15	6.30	15.80 34.83	1 / 1
33852-250	1" 25.40	Long anvil	1-25/32" M45	3000	2500 3388	24-7/8" 632	1/2" BSPT / NPT	3/4"	6.2 90	411 14.5	101.91	6.49	18.70 41.23	1 / 1
33911-250	1-1/2" 38.10	Std. anvil	1-25/32" M45	3000	2500 3388	17-53/64" 453	1/2" BSPT / NPT	3/4"	6.2 90	411 14.5	104.13	6.32	15.80 34.83	1 / 1
33912-250	1-1/2" 38.10	Long anvil	1-25/32" M45	3000	2500 3388	23-53/64" 605	1/2" BSPT / NPT	3/4"	6.2 90	411 14.5	103.90	6.53	18.70 41.23	1 / 1
33921-300	1-1/2" 38.10	Std. anvil	2" M50	3000	3000 4065	17-3/4" 451	1/2" BSPT / NPT	3/4"	6.2 90	453 16.0	104.52	8.86	19.70 43.43	1 / 1
33922-300	1-1/2" 38.10	Long anvil	2" M50	3000	3000 4065	25-15/32" 647	1/2" BSPT / NPT	3/4"	6.2 90	453 16.0	104.52	7.12	22.80 50.27	1 / 1

Impact Socket & Wrench Set

44116MP





1/2"



Blow case size (mm) :
315 x 250 x 120 (0.334 cuft)

- 10 PC. impact sockets 9~27mm
- 3 PC. thin wall impact sockets 17, 19, 21mm
- 1 PC. impact wrench
- 1 PC. extension bar
- 1 PC. universal joint
- 2 PC. ring \varnothing 3.5 x 19mm & \varnothing 3.5 x 23mm
- 2 PC. pin \varnothing 3 x 20 & \varnothing 3 x 25 (6150)
- 1 PC. air inlet adapter

21
PC.

KT NO.	Contents	kg 6.1	1 / 4
44116MP	 4535M 9, 10, 11, 13, 14, 17, 19, 22, 24, 27		 SY-221M (1/4"BSPT)
44116MP04	 4415M 17, 19, 21  4260-05  4797	33411-040	 SY-2-11M (1/4"BSPT)
44116MP10	 90601  90602  90401  90402		 SY-231M (1/4"NPT)

44118MP





1/2"



Blow case size (mm) :
420 x 315 x 100 (0.475 cuft)

- 14 PC. deep impact sockets 10~27mm
- 1 PC. impact wrench
- 2 PC. extension bars, 3" & 5" L
- 1 PC. universal joint
- 2 PC. ring \varnothing 3.5 x 19mm & \varnothing 3.5 x 23mm
- 2 PC. pin \varnothing 3 x 20mm & \varnothing 3 x 25mm (6150)
- 1 PC. air inlet adapter

23
PC.

KT NO.	Contents	kg 8.4	1 / 2
44118MP	 4435M 10, 11, 12, 13, 14, 16, 17, 19, 21, 22, 23, 24, 26, 27		 SY-221M (1/4"BSPT)
44118MP04	 4260-03  4260-05  4797	33411-040	 SY-211M (1/4"BSPT)
44118MP10	 90601  90602  90401  90402		 SY-231M (1/4"NPT)



PNEUMATIC TOOLS

Impact Socket & Wrench Set

44106AMP01

1/2"



Blow case size (mm) :
422 x 275 x 85 (0.35 cuft)

- 10 PC. impact sockets 9~27mm
- 3 PC. thin wall impact sockets 17, 19, 21mm
- 1 PC. impact wrench
- 1 PC. extension bar & with ball
- 1 PC. universal joint
- 1 PC. air inlet adapter

17
PC.

Contents

6.32 kg / 1 / 2

	4535M	9, 10, 11, 13, 14, 17, 19, 22, 24, 27
	4415M	17, 19, 21
	4260-05P	5"
	4799P	
	33411-050	
	SY-211M	(1/4"BSPT)

44108AMP01

1/2"



Blow case size (mm) :
422 x 275 x 85 (0.35 cuft)

- 14 PC. deep impact sockets 8~27mm
- 1 PC. impact wrench
- 2 PC. extension bar & with ball, 3" & 5" L
- 1 PC. universal joint
- 1 PC. air inlet adapter

19
PC.

Contents

7.92 kg / 1 / 2

	4435M	8, 10, 12, 13, 14, 15, 16, 17, 18, 19, 21, 22, 24, 27
	4260P	3", 5"
	4799P	
	33411-050	
	SY-211M	(1/4"BSPT)

Impact Socket & Wrench Set

44801FMP

1/2"



- 12 PC. standard impact sockets 10~24mm
- 1 PC. impact wrench
- 3 PC. thin wall impact sockets with plastic sleeve 17, 19, 21mm
- 1 PC. extension bar 3" L
- 1 PC. universal joint
- 1 PC. air inlet adapter
- 1 PC. lube

Blow case size (mm) :
422 x 275 x 85mm (0.35cuff)

20
PC.

KT NO.	Contents	Weight 5.79	Volume 1 / 4
44801FMP	4535M 10, 11, 12, 13, 14, 16, 17, 18, 19, 21, 22, 24		SY-221M (1/4"BSPT)
44801AMP	4945M 17, 19, 21		SY-211M (1/4"BSPT)
44801BMP	4260-03P 4797P LUBE15		SY-231M (1/4"NPT)

44801FMP01

1/2"



- 12 PC. standard impact sockets 10~24mm
- 1 PC. impact wrench
- 3 PC. thin wall impact sockets with plastic sleeve 17, 19, 21mm
- 1 PC. extension bar 3" L
- 1 PC. universal joint
- 1 PC. air inlet adapter
- 1 PC. lube

Blow case size (mm) :
422 x 275 x 85mm (0.35cuff)

20
PC.

KT NO.	Contents	Weight 6.03	Volume 1 / 4
44801FMP01	4535M 10, 11, 12, 13, 14, 16, 17, 18, 19, 21, 22, 24		SY-221M (1/4"BSPT)
44801AMP01	4945M 17, 19, 21 4260-03P 4797P LUBE15		SY-211M (1/4"BSPT)

44802FMP

1/2"



- 11 PC. standard impact sockets 10~24mm
- 1 PC. impact wrench
- 1 PC. extension bar
- 1 PC. universal joint
- 1 PC. air inlet adapter
- 1 PC. lube

Blow case size (mm) :
340 x 263 x 80mm (0.253 cuff)

16
PC.

KT NO.	Contents	Weight 3.9	Volume 1 / 3
44802FMP	4535M		SY-221M (1/4"BSPT)
44802AMP	10, 12, 13, 14, 16, 17, 18, 19, 21, 22, 24,		SY-211M (1/4"BSPT)
44802BMP	4260-05P 4796P LUBE15		SY-231M (1/4"NPT)

Impact Socket & Wrench Set

44803FMP







1/2"



Blow case size (mm) :
422 x 275 x 85mm (0.35cuff)

15
PC.

- 7 PC. standard impact sockets 17~27mm
- 1 PC. impact wrench
- 3 PC. deep impact sockets 17, 19, 21mm
- 1 PC. extension bar 5" L
- 1 PC. universal joint
- 1 PC. air inlet adapter
- 1 PC. lube

KT NO.	Contents	Weight 5.7	Volume 1 / 4
44803FMP	 4535M 17, 18, 19, 21, 22, 24, 27		 SY-221M (1/4"BSPT)
44803AMP	 4435M 17, 19, 21		 SY-211M (1/4"BSPT)
44803BMP	 4260-05P  4799P LUBE15		 SY-231M (1/4"NPT)

64801FMP

3/4"



Blow case size (mm) :
422 x 275 x 85mm(0.35 cuff)

13
PC.

- 8 PC. standard impact sockets 19~38mm
- 1 PC. impact wrench
- 1 PC. extension bar 7" L
- 1 PC. universal joint
- 1 PC. air inlet adapter
- 1 PC. lube

KT NO.	Contents	Weight 8.48	Volume 1 / 2
64801FMP	 6515M 19, 22, 24, 27, 30		 SY-221M (1/4"BSPT)
64801AMP	 6535M 32, 36, 38		 SY-211M (1/4"BSPT)
64801BMP	 6260-07P  6797P LUBE15		 SY-231M (1/4"NPT)

64114FMP







3/4"

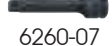

Blow case size (mm) :
422 x 360 x 110 (0.59 cuff)

18
PC.

- 11 PC. impact sockets 19~38mm
- 1 PC. impact wrench
- 1 PC. extension bar, 7" L (w/o ball)
- 1 PC. universal joint
- 1 PC. ring Ø 5.5 x 37mm
- 1 PC. pin Ø 4.0 x 35mm
- 1 PC. air inlet adapter
- 1 PC. lube

KT NO.	Contents	Weight 12.32	Volume 1 / 2
64114FMP	 6535M 19, 22, 24, 27, 28, 30, 32, 33, 34, 36, 38		 SY-221M (1/4"BSPT)
64114AMP	 6260-07  6797  90603  90404 LUBE15		 SY-211M (1/4"BSPT)

Impact Screwdriver

3312



1/4"
33121
33122



KT NO.	Collect Size Inch mm	Std. bolt size Inch mm	Free speed R.P.M	Max. torque lbf-ft N-m	Overall length Inch mm	Air inlet Inch	Air hose ID	Air pressure bar psi	Avg. air consumption L/min CFM	Sound DBA	Vib M/S ²	Net weight kgs lbs
33121	1/4"	6.35 3/16" M5	11000	75 102	7-1/4" 183	1/4"BSPT	3/8"	6.2 90	96 3.4	92.8	3.83	0.82 1.81 1 / 20
33122	1/4"	6.35 3/16" M5	11000	75 102	7-1/4" 183	1/4"NPT	3/8"	6.2 90	96 3.4	92.8	3.83	0.82 1.81 1 / 20

Air Ratchet Wrench

37221 / 37321

37334 / 37434

- Ergonomically enhanced composite handle
- Dual pawl design provides higher torque



1/4" & 3/8"
37221
37321
3/8" & 1/2"
37334
37434



- Dust-free design
- Prevents deformation and triples the life of the parts

KT NO.	Square drive Inch mm	Type Std./Long anvil	Std. bolt size Inch mm	Free speed R.P.M	Max. torque ft-lb N-m	Overall length Inch mm	Air inlet Inch	Air hose ID	Air pressure bar psi	Avg. air consumption L/min CFM	Sound DBA	Vib M/S ²	Net weight kgs lbs
37221-030	1/4"	6.35 Std. anvil	1/4" M6	250	30 41	8-1/16" 205	1/4"BSPT	3/8"	6.2 90	79 2.8	86.00	2.32 0.67 1.48	1 / 30
37221-031	1/4"	6.35 Std. anvil	1/4" M6	250	30 41	8-1/16" 205	1/4"NPT	3/8"	6.2 90	79 2.8	86.00	2.32 0.67 1.48	1 / 30
37321-050	3/8"	9.53 Std. anvil	5/16" M8	270	50 68	8-1/16" 205	1/4"BSPT	3/8"	6.2 90	79 2.8	93.00	2.26 0.67 1.48	1 / 30
37321-051	3/8"	9.53 Std. anvil	5/16" M8	270	50 68	8-1/16" 205	1/4"NPT	3/8"	6.2 90	79 2.8	93.00	2.26 0.67 1.48	1 / 30
37334-080	3/8"	9.53 Std. anvil	3/8" M10	210	80 108	10-39/64" 268	1/4"BSPT	3/8"	6.2 90	127 4.5	93.00	3.58 1.25 2.76	1 / 10
37334-081	3/8"	9.53 Std. anvil	3/8" M10	210	80 108	10-39/64" 268	1/4"NPT	3/8"	6.2 90	127 4.5	93.00	3.58 1.25 2.76	1 / 10
37434-080	1/2"	12.70 Std. anvil	3/8" M10	210	80 108	10-39/64" 268	1/4"BSPT	3/8"	6.2 90	127 4.5	92.00	3.91 1.26 2.78	1 / 10
37434-081	1/2"	12.70 Std. anvil	3/8" M10	210	80 108	10-39/64" 268	1/4"NPT	3/8"	6.2 90	127 4.5	92.00	3.91 1.26 2.78	1 / 10

Super Duty Air Ratchet Wrench

37323

37423

- Ergonomically enhanced composite handle
- 360° exhaust rotation leads the air away from working area
- Unique head design: dust free and prevent deformation and triples the life of parts
- Dual pawl design provides higher torque



3/8" & 1/2"

37323
37423



KT NO.	Square drive inch mm	Type Std./Long anvil	Std. bolt size inch mm	Free speed R.P.M	Max. torque ft-lb N-m	Overall length inch mm	Air inlet inch	Air hose ID	Air pressure bar psi	Avg. air consumption L/min CFM	Sound DBA	Vib M/S2	Net weight kgs lbs
37323-080	3/8" 9.53	Std. anvil	3/8" M10	280	80 108	11" 279	1/4"BSPT	3/8"	6.2 90	113 4.0	94.00	2.52	1.25 2.76 1 / 12
37323-081	3/8" 9.53	Std. anvil	3/8" M10	280	80 108	11" 279	1/4"NPT	3/8"	6.2 90	113 4.0	94.00	2.52	1.25 2.76 1 / 12
37423-080	1/2" 12.70	Std. anvil	3/8" M10	280	80 108	11" 279	1/4"BSPT	3/8"	6.2 90	113 4.0	93.00	2.07	1.25 2.76 1 / 12
37423-081	1/2" 12.70	Std. anvil	3/8" M10	280	80 108	11" 279	1/4"NPT	3/8"	6.2 90	113 4.0	93.00	2.07	1.25 2.76 1 / 12

Air Ratchet Wrench

37235 / 37335 / 37435

- Working around tightly packed engines, machinery and equipment



1/4" & 3/8"

37235
37335



3/8"

37335

1/2"

37435



KT NO.	Square drive inch mm	Free Speed R.P.M	Max. Torque ft-lb N-m	Overall Length inch mm	Air inlet inch	Air Hose ID	Air Pressure bar psi	Avg. Air Consumption L/min CFM	Sound DBA	Vib M/S2	Net Weight kgs lbs
37235-030	1/4" 6.35	230	30 41	6-1/8" 155	1/4"BSPT	3/8"	6.2 90	71 2.5	92.00	10.50	0.49 1.08 1 / 20
37235-031	1/4" 6.35	230	30 41	6-1/8" 155	1/4"NPT	3/8"	6.2 90	71 2.5	92.00	10.50	0.49 1.08 1 / 20
37335-030	3/8" 9.53	230	30 41	6-1/8" 155	1/4"BSPT	3/8"	6.2 90	71 2.5	92.00	10.50	0.49 1.08 1 / 20
37435-075	1/2" 12.70	200	75 102	10-1/4" 260	1/4"BSPT	3/8"	6.2 90	113 4.0	92.00	10.50	1.20 2.64 1 / 20
37435-076	1/2" 12.70	200	75 102	10-1/4" 260	1/4"NPT	3/8"	6.2 90	113 4.0	92.00	10.50	1.20 2.64 1 / 20

Continuous Flow Air Grease Gun

9BV14

- Ideal for machine, automobile, farm and garden equipments, vehicles etc.
- 360° rotating handle



KT NO.	Air inlet (Inch)	Screw Thread	Air Source Range input (psi/bar)	output (psi/bar)	Recommended Air Source input (psi/bar)	output (psi/bar)	Capacity c.c. oz	kg
9BV1420	1/4"BSPT	M10 x 1.0P	60~150 psi (4.2~10.3 bar)	2400~6000 psi (165~413 bar)	90 psi (6.2 bar)	3600 psi (250 bar)	400 14	1.7 1 / 10

9BV1420 For Germany, South Africa, Egypt, etc.

Continuous Flow Air Grease Gun with 12" Tube

9BV14T

- Ideal for machine, automobile, farm and garden equipments, vehicles etc.
- 360° rotating handle

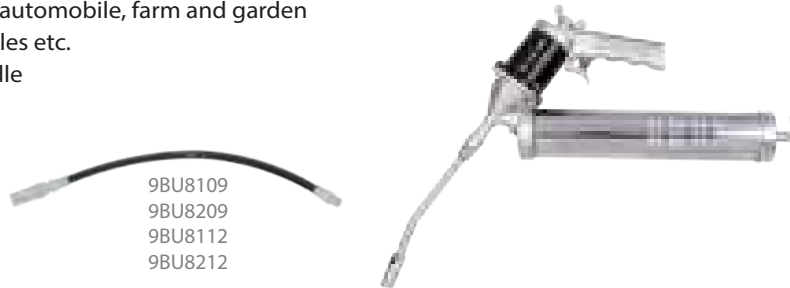

KT NO.	Air Inlet (inch)	Screw Thread	Air Source Range input (psi/bar)	output (psi/bar)	Recommended Air Source input (psi/bar)	output (psi/bar)	Capacity c.c.	oz	Kg	Box
9BV1420T	1/4"BSPT	M10 x 1.0P	60~150 psi (4.2~10.3 bar)	2400~6000 psi (165~413 bar)	90 psi (6.2 bar)	3600 psi (250 bar)	400	14	1.7	1 / 10
9BU8109	9" length	1/8"-28NPT								
9BU8209	9" length	M10 x 1.0P								
9BU8112	12" length	1/8"-28NPT								
9BU8212	12" length	M10 x 1.0P								

9BV1420T For Germany, South Africa, Egypt, etc.

Air Blow Gun

7990

- Ideal for cleaning
- Steel nozzle & nylon fiber handle
- Air pressure : 90 psi recommended
- Air consumption : 1/4" hose-13cfm-350l/min, 3/8" hose-15cfm-430l/min
- Sound pressure : 85~90 dB
- Working pressure : 75~120 psi/5.3~8.4 kgf/cm²
- Max pressure : 200 psi/ 14.07 kgf/cm²

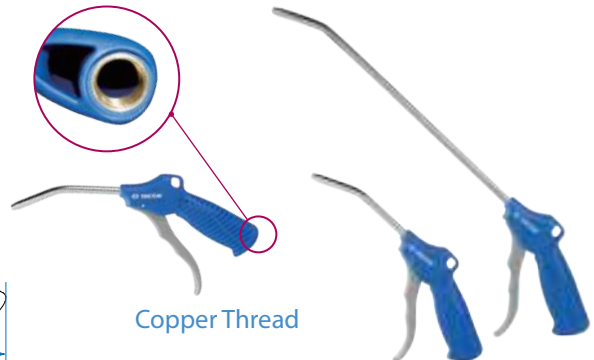
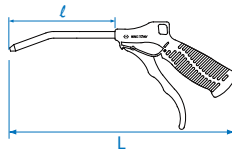

KT NO.	Air Inlet Inch	l Inch	mm	L (mm)	Kg	Box
79900-04	1/4"BSPT	4	100	245	200	20 / 100
79900-10	1/4"BSPT	10	250	420	240	25 / 50
79900-13	1/4"BSPT	13	330	475	260	25 / 50
79900-20	1/4"BSPT	20	500	650	300	25 / 50

KT NO.	Air Inlet Inch	l Inch	mm	L (mm)	Kg	Box
79901-04	1/4"NPT	4	100	245	200	20 / 100
79901-10	1/4"NPT	10	250	420	240	25 / 50
79901-13	1/4"NPT	13	330	475	260	25 / 50
79901-20	1/4"NPT	20	500	650	300	25 / 50

Spray Gun

79982

- Suitable for spraying a wide range of oils, cleaning agents and rustproofing liquids
- Fitted with fluid/air control valve



79982-06



79982-10

KT NO.	Max Capacity	Working Pressure(psi)	Air inlet connection	Kg	Box
79982-06	600 c.c	90-150	1/4" BSPT(EU)	600	1 / 10
79982-10	1000 c.c	90-150	1/4" BSPT(EU)	800	1 / 10

3-In-1 Inflator

9BM

- Diaphragm pressure gauge
- Accuracy: ANSI B40.100 $\pm 3\%$ ~ $\pm 2\%$ ~ $\pm 3\%$
- Special rubber housing protects manometer against light impacts
- 3 functions(check, release, inflator) all together on the press handle
- Variable trigger, two control positions for inflate/deflate level
- Flexible 400MM high pressure rubber hose with clip-on air tire chuck
- Pressure Range:
0-160 psi (9BM21) / 0-220 psi (9BM22)
- Built in hang-up hook allows easy storage

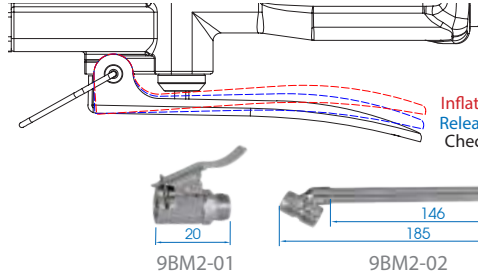

9BM2110
9BM2111
9BM2210
9BM2211



9BM2110A
9BM2111A

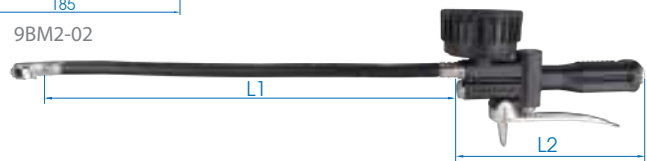

KT NO.	Pressure range (psi)	Air Inlet (BSPT/NPT)	L (mm)		Air hose (ID)	g	/ /
			L1	L2			
9BM2110	160	1/4"BSPT	Ø13 x 400	180	3/8"	500	1 / 12
9BM2111	160	1/4"NPT	Ø13 x 400	180	3/8"	500	1 / 12
9BM2210	220	1/4"BSPT	Ø13 x 400	180	3/8"	520	1 / 12
9BM2211	220	1/4"NPT	Ø13 x 400	180	3/8"	520	1 / 12
9BM2210A	220	1/4"BSPT	Ø13 x 400	180	3/8"	600	1 / 12
9BM2211A	220	1/4"NPT	Ø13 x 400	180	3/8"	600	1 / 12
9BM2-01	(included in all 9BM series)			20	-	25	-
9BM2-02	(included in 9BM2210A & 11A only)			185	-	105	-

PU Air Spiral Hose

79953

79960

79962

- Super mechanical strength and excellent abrasive resistance
- Superior heat and cold resistance
- Oil resistance
- Light weight
- Temperature resistance from -20°C ~ $+60^{\circ}\text{C}$



KT NO.	Hose I.D. (mm)	Hose O.D. (mm)	Hose Length (M)	Working Pressure		Maximum Pressure		Type	Male PT Fitting (Inch)	Weight		/ /
				(psi)	(bar)	(psi)	(bar)			(kgs)	(lbs)	
79953-10	8	12	10	108	7.4	320	22.2	-	1/4"BSPT	0.80	1.76	1 / 20
79953-15	8	12	15	108	7.4	320	22.2	-	1/4"BSPT	1.30	2.87	1 / 16
79960-10	8	12	10	160	11.0	640	44.1	Asian	1/4"BSPT	0.93	2.05	1 / 20
79960-15	8	12	15	160	11.0	640	44.1	Asian	1/4"BSPT	1.31	2.87	1 / 16
79960-20	8	12	20	160	11.0	640	44.1	Asian	1/4"BSPT	1.66	3.64	1 / 10
79962-10	8	12	10	160	11.0	640	44.1	EU	1/4"BSPT	0.92	2.02	1 / 20
79962-15	8	12	15	160	11.0	640	44.1	EU	1/4"BSPT	1.31	2.87	1 / 16
79962-20	8	12	20	160	11.0	640	44.1	EU	1/4"BSPT	1.63	3.78	1 / 10

Air Hose Reel

7991

- Automatic rewind with SK5 alloy steel spring
- 16 teeth gear-stop ensures safety
- 300 psi working pressure allowed
- Sturdy structure with 0.7mm thick steel rail stored in iron case
- Replaceable air hose design & hanging rack



CAUTION
Do not pull the air hose when seeing tag



- Pull the air hose to the end till it shows joint replacement



- Install new air hose



- Dismantle connection



- 16 teeth gear design can spread stress evenly and stop returning

1 Bar = 1.01972 kgf/cm²
1 Bar = 14.5036 psi

KT NO.	Hose I.D. mm	Hose O.D. mm	Hose length (M)	Type	Air Inlet / outlet inch	Working pressure psi		
79910-10	8	12	10	Asian	1/4"BSPT	300	5.5	1 / 2
79910-15	8	12	15	Asian	1/4"BSPT	300	6.5	1 / 2
79911-10	8	12	10	US	1/4"NPT	300	5.5	1 / 2
79911-15	8	12	15	US	1/4"NPT	300	6.5	1 / 2
79912-10	8	12	10	EU	1/4"BSPT	300	5.5	1 / 2
79912-15	8	12	15	EU	1/4"BSPT	300	6.5	1 / 2

Air Lubricator

799A

- Semi auto drain valve
- Steel guards offer better protection
- Easy installation and disassembly

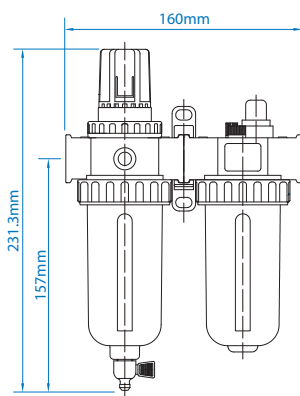

KT NO.	Port Size (inch)	Filter Element (μ)	Max Input Pressure (psi)	Max Output Pressure (psi)	Max Flow (L/min)	Operation Temperature Range (°C)	Drain Capacity (ml)	Oil Capacity (ml)	Air Inlet (inch)	Weight (Kgs)	Weight (lbs)	
799A0-23C	1/4"	5	215	7~150	1750	5 ~ 60	80	150	1/4"BSPT	1.40	3.17	1 / 12
799A1-23C	1/4"	5	215	7~150	1750	5 ~ 60	80	150	1/4"NPT	1.42	3.17	1 / 12
799A0-33C	3/8"	5	215	7~150	2500	5 ~ 60	80	150	3/8"BSPT	1.14	2.51	1 / 12
799A1-33C	3/8"	5	215	7~150	2500	5 ~ 60	80	150	3/8"NPT	1.14	2.51	1 / 12
799A0-43C	1/2"	5	215	7~150	3000	5 ~ 60	80	150	1/2"BSPT / NPT	1.15	2.53	1 / 12

Air Quick Coupler

KT NO.	Size	Type			
SY-211M	1/4"BSPT	European		21.4	12 / 504
SY-211F				22.8	10 / 420
SY-210M				88.4	20 / 240
SY-221M	1/4"BSPT	Asian		24.4	12 / 504
SY-221F				28.6	10 / 420
SY-260M				81.6	20 / 240
SY-210H	1/4" hose	European		78.0	15 / 180
SY-211H				18.0	10 / 320
SY-220H		Asian		87.0	10 / 320
SY-221H				31.0	10 / 320
SY-231M	1/4"NPT	American		23.6	12 / 504
SY-231F				21.2	10 / 420
SY-230M				85.5	20 / 240
SY-310H	3/8" hose	European		75.0	15 / 180
SY-311H				22.0	10 / 320
SY-320H		Asian		78.0	15 / 180
SY-321H				23.0	10 / 320
SY-410H	1/2" hose	European		82.0	15 / 180
SY-411H				26.0	10 / 320
SY-421M	1/2" BSPT/NPT	Asian		24.4	12 / 504

Mini Lubricator

33411-71

1/4"



KT NO.	Size		
33411-71	1/4"-19BSPT	90	1 / 150

Repair Tools Set

14103GP

- 3 PC. Impact wrench repair tools set
- Suitable for 33411-040, 33411-050, 33412-050, 33611-055, 33621-075, 33622-075

3 PC.

Contents  0.58  1 / 20

33011 

33012 

33013 

Impact Wrench Holder

9145

- Applied for 1/4" & 3/4" DR. air tools



KT NO.	Size	Type		
91451-01A	1/4" BSPT	European	268.8	1 / 48
91451-01B	1/4" NPT	American	271.2	1 / 48
91451-01F	1/4" BSPT	Asian	272.8	1 / 48

871061

- Applied for 3/8" & 1/2" DR. air tools



KT NO.	Size	Type		
871061A	1/4" x 19 BSPT	European		
871061B	1/4" x 18 NPT	American	450	1 / 24
871061F	1/4" x 19 BSPT	Asian		

Tools Display Stand Set

87156A

- Overall Size - W 280 x D 170 x H 45 mm

1.9 1 / 1

Contents

	87156
	87154-01
	SY-210M x3
	SY-20A x6
	SY-10A x3





TORQUE CONTROL & MULTIPLIERS

Recyclable cylindrical package

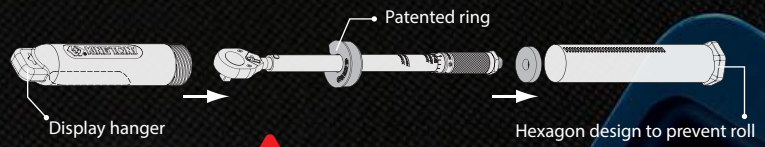

1. Do not use this torque wrench over its scale range.
2. Do not use this torque wrench as a normal hand tool.
3. Torque wrench need to be calibrated periodically for accuracy.

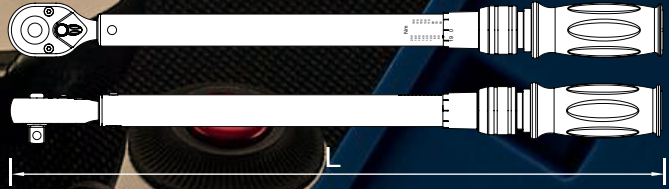

1 N·m = 0.738 ft·lb = 0.102 kgf·m
 1 ft·lb = 1.356 N·m = 0.138 kgf·m
 1 in·lb = 0.113 N·m = 1.152 kgf·cm

Calibration Instruction And Reminder of Torque Wrench

In test conditions, the torque wrench should remain within the tolerances laid down by DIN ISO 6789:2017 & ASME B107.300-2010 for 5000 cycles.

Practically, this may be affected and changed by ingress of dust, causing wear, or by damage caused by using the tool improperly such as to loosen fasteners or being dropped regularly.

Assume the users are trained to use the torque wrenches, and follow the manual, a period of twelve months is reasonable for torque wrenches used in non safety critical areas.

For those tools used in critical applications, a three month or even monthly check would be suggested.



Calibration Certificate

Master Torque Control

62 SERIES

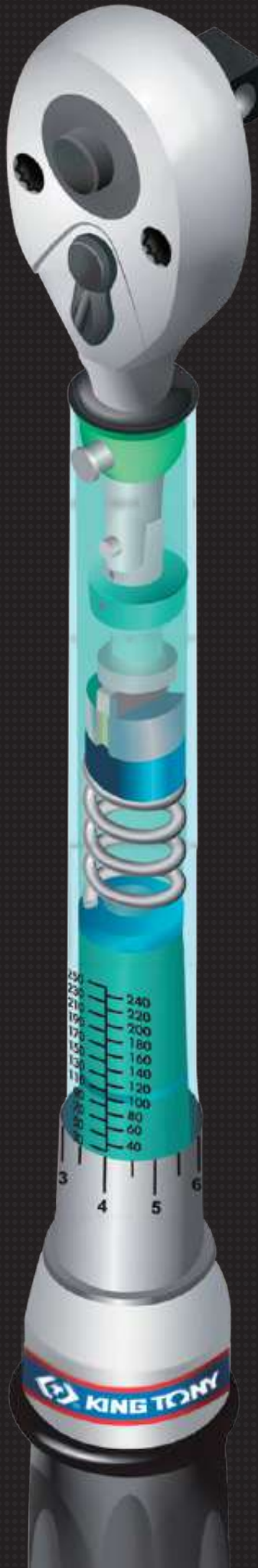

Quick:

- Quick release and fine tooth gears design increases efficiency for safety tightening



Sound:

- Click sound and vibration reminds operator to stop in correct torque



Lubrication:

- Apply top industrial level lubrication to reduce friction and keep performance in good condition much longer



Spring:

- Made of high quality alloy steel to offer extended working cycles



Frame:

- Hardened tube provides extreme durability against friction to assure precision of tolerance



Easy:

- Auto lock design of torque adjustment provides quick and comfortable working experience

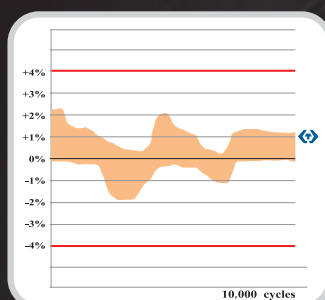

- **±3% tolerance of torque and 10,000 cycles durability performs better than international standard "DIN ISO 6789:2017 & ASME B107.300-2010" with ±4% tolerance and 5,000 cycles requirement**



Heavy Duty Adjustable Torque Wrench

Design for easy torque adjustment

Quality accords to DIN ISO 6789:2017 & ASME B107.300-2010

Tolerance of torque $\pm 3\%$ (CW)

CW/CCW Direction



Video QR Code

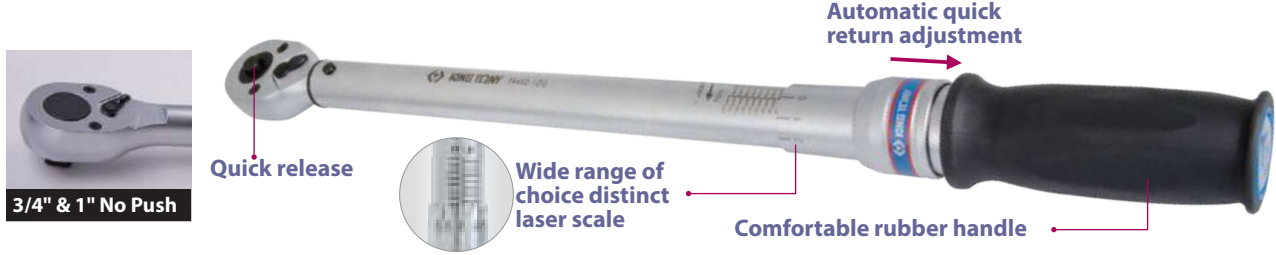

Dual Scale - English & Newton Meter (in-lb / ft-lb & N-m)

KT NO.	Gear teeth	Square drive	Torque range in-lb / ft-lb	Incr.	Torque range N-m	Incr.	Overall length mm		
34262-1CG	24	1/4"	40~200 in-lb	1 in-lb	5.1~22.0 N-m	0.12 N-m	324	640	1 / 12
34362-1CG	24	3/8"	40~200 in-lb	1 in-lb	5.1~22.0 N-m	0.12 N-m	324	640	1 / 12
34362-2CG	32	3/8"	15~80 ft-lb	0.5 ft-lb	23.7~105.1 N-m	0.7 N-m	435	1300	1 / 12
34462-1CG	32	1/2"	20~150 ft-lb	1 ft-lb	34~197 N-m	1.4 N-m	521	1590	1 / 12
34462-2CG	32	1/2"	50~250 ft-lb	1 ft-lb	75~332 N-m	1.4 N-m	613	1810	1 / 12
34662-1CG	24	3/4"	100~450 ft-lb	5 ft-lb	169~576 N-m	6.8 N-m	1048	5500	1 / 2
34662-2CG	24	3/4"	100~600 ft-lb	5 ft-lb	169~779 N-m	6.8 N-m	1234	5600	1 / 2
34662-3CG	24	3/4"	150~750 ft-lb	5 ft-lb	237~983 N-m	6.8 N-m	1238	6150	1 / 2
34862-1CG	24	1"	150~750 ft-lb	5 ft-lb	237~983 N-m	6.8 N-m	1238	6150	1 / 2

Single scale - Newton Meter (N-m)

KT NO.	Gear teeth	Square drive	Torque range N-m	Incr.	Overall length mm		
34262-1DG	24	1/4"	4~20 N-m	0.1 N-m	324	640	1 / 12
34262-2DG	24	1/4"	2~10 N-m	0.1 N-m	281	560	1 / 12
34262-3DG	24	1/4"	5~30 N-m	0.5 N-m	325	640	1 / 12
34362-1DG	24	3/8"	4~20 N-m	0.1 N-m	324	640	1 / 12
34362-2DG	32	3/8"	20~100 N-m	0.5 N-m	435	1300	1 / 12
34362-3DG	32	3/8"	10~60 N-m	0.5 N-m	325	700	1 / 12
34462-1DG	32	1/2"	40~200 N-m	1 N-m	521	1590	1 / 12
34462-2DG	32	1/2"	60~340 N-m	2 N-m	613	1810	1 / 12
34462-3DG	32	1/2"	20~100 N-m	1 N-m	436	1300	1 / 12
34462-4DG	32	1/2"	80~400 N-m	2 N-m	613	1970	1 / 12
34662-1DG	24	3/4"	100~600 N-m	5 N-m	1048	5500	1 / 2
34662-2DG	24	3/4"	150~800 N-m	5 N-m	1234	5600	1 / 2
34662-3DG	24	3/4"	200~1000 N-m	5 N-m	1238	6150	1 / 2
34862-1DG	24	1"	200~1000 N-m	5 N-m	1238	6150	1 / 2

- 34262-1DK
- 34362-1DK
- 34362-2DK:
- 34362-2xx / 3xx
- 34462-1DK
- 34462-3DK: 34462-3DG / 3GG
- 34662-1DK
- 34662-3DK1: 34662-3xxx series
- 34862-2DK: series

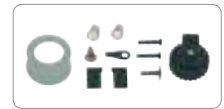

Single scale - English (in-lb / ft-lb)

KT NO.	Gear teeth	Square drive	Torque range in-lb / ft-lb	Incr.	Overall length mm		
34662-4EG	24	3/4"	60~300 ft-lb	2 ft-lb	614	1800	1 / 12
34862-1EG	24	1"	150~750 ft-lb	5 ft-lb	1238	6150	1 / 2

Dual Scale - Newton Meter & English (N-m & ft-lb)

KT NO.	Gear teeth	Square drive	Torque range N-m	Incr.	Torque range ft-lb	Incr.	Overall length mm		
34462-2FG	32	1/2"	60~340 N-m	2 N-m	51.6~243.4 ft-lb	1.5 ft-lb	613	1720	1 / 12
34862-1FG	24	1"	200~1000 N-m	5 N-m	166~719 ft-lb	5 ft-lb	1238	6150	1 / 2

Dual Scale - Kilogram-force Centimeter / Kilogram-force meter & Newton Meter (kgf-cm / kgf-m & N-m)

KT NO.	Gear teeth	Square drive	Torque range kgf-cm / kgf-m	Incr.	Torque range N-m	Incr.	Overall length mm		
34262-1GG	24	1/4"	40~200 Kgf-cm	1 Kgf-cm	4.4~19.1 N-m	0.92 N-m	324	640	1 / 12
34362-1GG	24	3/8"	40~200 Kgf-cm	1 Kgf-cm	4.4~19.1 N-m	0.92 N-m	324	640	1 / 12
34362-2GG	32	3/8"	200~1000 Kgf-cm	5 Kgf-cm	22.1~95.6 N-m	0.46 N-m	435	1300	1 / 12
34462-1GG	32	1/2"	400~2000 Kgf-cm	10 Kgf-cm	44.1~191.2 N-m	0.46 N-m	521	1590	1 / 12
34462-2GG	32	1/2"	6~34 Kgf-m	0.2 Kgf-m	68.6~323.6 N-m	1.82 N-m	613	1810	1 / 12
34462-3GG	32	1/2"	200~1000 Kgf-cm	5 Kgf-cm	22.1~95.6 N-m	4.9 N-m	436	1470	1 / 12
34662-1GG	24	3/4"	10~60 Kgf-m	0.5 Kgf-m	123~564 N-m	4.9 N-m	1048	5500	1 / 2
34662-2GG	24	3/4"	15~80 Kgf-m	0.5 Kgf-m	172~760 N-m	4.9 N-m	1234	5600	1 / 2
34662-3GG	24	3/4"	20~100 Kgf-m	0.5 Kgf-m	221~956 N-m	4.9 N-m	1238	6150	1 / 2
34862-1GG	24	1"	20~100 Kgf-m	0.5 Kgf-m	221~956 N-m	4.9 N-m	1238	6150	1 / 2

Heavy Duty Adjustable Torque Wrench

Design for easy torque adjustment

Quality accords to DIN ISO 6789:2017 & ASME B107.300-2010

Tolerance of torque $\pm 3\%$ (CW)

CW/CCW Direction



In order to ensure correct torque the extension bar must be used

Dual Scale - English & Newton Meter (ft-lb & N-m)

KT NO.	Square drive	Torque Range ft-lb	Incr.	Torque range N-m	Incr.	Overall length mm	kg	Box/Kit
34862-2CG	1"	200~1000 ft-lb	5 ft-lb	305~1322 N-m	6.8 N-m	1850	12.20	1 / 2
34862-2CF	1"	200~1000 ft-lb	5 ft-lb	305~1322 N-m	6.8 N-m	1850	12.20	1 / 2

Single scale - Newton Meter (N-m)

KT NO.	Square drive	Torque range N-m	Incr.	Overall length mm	kg	Box/Kit
34862-2DF	1"	300~1500 N-m	10 N-m	1850	12.20	1 / 2
34862-2DG	1"	300~1500 N-m	10 N-m	1850	12.20	1 / 2

Single scale - English (ft-lb)

KT NO.	Square drive	Torque Range ft-lb	Incr.	Overall length mm	kg	Box/Kit
34862-2EG	1"	200~1000 ft-lb	5 ft-lb	1850	12.20	1 / 2
34862-2EF	1"	200~1000 ft-lb	5 ft-lb	1850	12.20	1 / 2



Dual Scale - Newton Meter & English (N-m & ft-lb)

KT NO.	Square drive	Torque range N-m	Incr.	Torque range ft-lb	Incr.	Overall length mm	kg	Box/Kit
34862-2FF	1"	300~1500 N-m	10 N-m	258~1070 ft-lb	7.4 ft-lb	1850	12.20	1 / 2
34862-2FG	1"	300~1500 N-m	10 N-m	258~1070 ft-lb	7.4 ft-lb	1850	12.20	1 / 2

Dual Scale - Kilogram-force meter & Newton Meter (kgf-m & N-m)

KT NO.	Square drive	Torque range kgf-m	Incr.	Torque range N-m	Incr.	Overall length mm	kg	Box/Kit
34862-2GG	1"	30~150 Kgf-m	1 Kgf-m	343~1422 N-m	5 N-m	1850	12.20	1 / 2



Heavy Duty Adjustable Torque Wrench

Design for easy torque adjustment

Quality accords to DIN ISO 6789:2017 & ASME B107.300-2010

Tolerance of torque $\pm 3\%$ (CW)

CW/CCW Direction

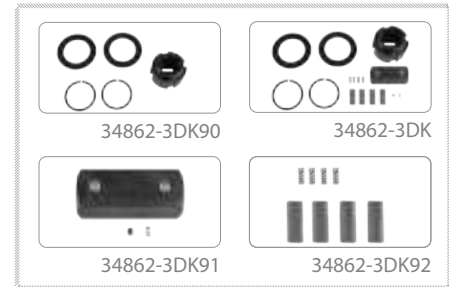
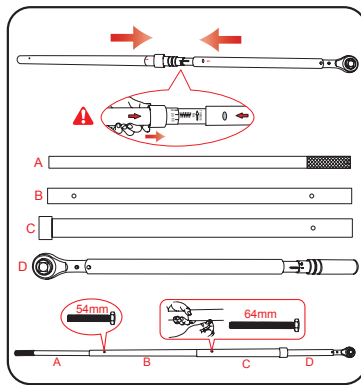
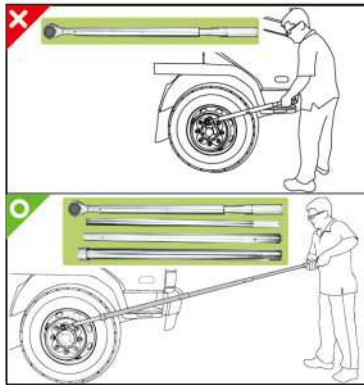

Dual Scale - English & Newton Meter (ft-lb & N-m)

KT NO.	Square drive	Torque range ft-lb	Incr.	Torque range N-m	Incr.	Overall length mm	kg	Box
34862-3CF	1"	400~2000	10 ft-lb	610~2644	13.55 N-m	2755	23.99	1 / 1
KT NO.	Square drive	Torque range N-m	Incr.	Torque range ft-lb	Incr.	Overall length mm	kg	Box
34862-3FF	1"	500~2500	20 N-m	443~1771	14.77 ft-lb	2755	25.38	1 / 1

Heavy Duty Mini-type Torque Wrench

Industrial application

Quality accords to DIN ISO 6789:2017 & ASME B107.300-2010

Tolerance of torque $\pm 3\%$ (CW)

CW/CCW Direction

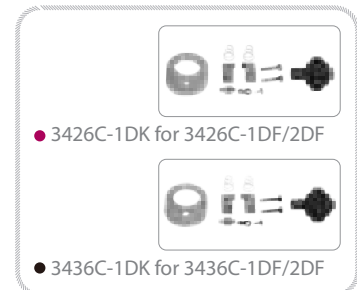

Single scale - Newton Meter (N-m)

KT NO.	Square drive	Torque range N-m	Incr.	Overall length mm	kg	Box
● 3426C-1DF	1/4"	3~15	0.1 N-m	211	330	24
● 3426C-2DF	1/4"	5~25	0.2 N-m	249	430	24
● 3436C-1DF	3/8"	3~15	0.1 N-m	211	450	24
● 3436C-2DF	3/8"	5~25	0.2 N-m	249	550	24

Heavy Duty 72 Teeth Adjustable Torque Wrench

Colorful quick release button design

Fixed head version allows using in narrow spaces

Quality accords to DIN ISO 6789:2017 & ASME B107.300-2010

Tolerance of torque $\pm 3\%$ (CW)

CW/CCW Direction



Single scale - Newton Meter (N-m)

KT NO.	Square drive	Torque range N-m	Incr.	Overall length mm			
● 3426A-1DG	1/4"	2~10 N-m	0.1 N-m	285	560	1 / 24	
● 3426A-2DG	1/4"	4~20 N-m	0.1 N-m	325	640	1 / 24	
● 3436A-2DG	3/8"	20~100 N-m	0.5 N-m	430	1300	1 / 12	
● 3446A-1DG	1/2"	40~200 N-m	1 N-m	490	1460	1 / 12	
● 3446A-2DG	1/2"	60~340 N-m	2 N-m	590	1750	1 / 12	

Single scale - English (in-lb/ft-lb)

KT NO.	Square drive	Torque range in-lb / ft-lb	Incr.	Overall length mm			
● 3426A-1EG	1/4"	20~100 in-lb	1 in-lb	285	560	1 / 24	
● 3426A-2EG	1/4"	40~200 in-lb	1 in-lb	325	640	1 / 24	
● 3436A-2EG	3/8"	15~80 ft-lb	0.5 ft-lb	430	1300	1 / 12	
● 3446A-1EG	1/2"	20~150 ft-lb	1 ft-lb	490	1460	1 / 12	
● 3446A-2EG	1/2"	50~250 ft-lb	1 ft-lb	590	1750	1 / 12	

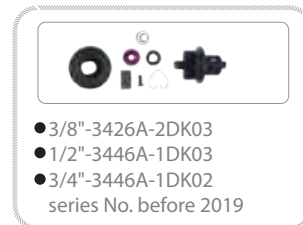

- 3/8"-3426A-2DK03
 - 1/2"-3446A-1DK03
 - 3/4"-3446A-1DK02
- series No. before 2019



Heavy Duty Interchangeable Torque Wrench

Using standard insert head

Positive button design which removes the insert head easily

Quality accords to DIN ISO 6789:2017 & ASME B107.300-2010

Tolerance of torque $\pm 3\%$ (CW)

CW/CCW Direction



Dual Scale - English & Newton Meter (in-lb/ft-lb & N-m)

KT NO.	Size mm	Torque range in-lb / ft-lb	Incr.	Torque range N-m	Incr.	Overall length mm		
34512-1CG	9 x 12	20~100 in-lb	1 in-lb	2.8~10.7 N-m	0.12 N-m	261	510	1 / 12
34512-2CG	9 x 12	40~200 in-lb	1 in-lb	5.1~22.0 N-m	0.12 N-m	306	590	1 / 12
34512-3CG	9 x 12	15~80 ft-lb	0.5 ft-lb	23.7~105.1 N-m	0.7 N-m	430	1270	1 / 12
34522-1CG	14 x 18	15~80 ft-lb	0.5 ft-lb	23.7~105.1 N-m	0.7 N-m	430	1270	1 / 12
34522-2CG	14 x 18	20~150 ft-lb	1 ft-lb	34~197 N-m	1.4 N-m	485	1410	1 / 12
34522-3CG	14 x 18	50~250 ft-lb	1 ft-lb	75~332 N-m	1.4 N-m	580	1590	1 / 12

Single scale - Newton Meter (N-m)

KT NO.	Size mm	Torque range N-m	Incr.	Overall length mm		
34512-1DG	9 x 12	2~10 N-m	0.1 N-m	261	510	1 / 12
34512-2DG	9 x 12	4~20 N-m	0.1 N-m	306	590	1 / 12
34512-4DG	9 x 12	10~60 N-m	0.5 N-m	306	590	1 / 12
34512-3DG	9 x 12	20~100 N-m	0.5 N-m	430	1270	1 / 12
34522-1DG	14 x 18	20~100 N-m	0.5 N-m	430	1270	1 / 12
34522-2DG	14 x 18	40~200 N-m	1 N-m	485	1410	1 / 12
34522-3DG	14 x 18	60~340 N-m	2 N-m	580	1590	1 / 12
34522-4DG	14 x 18	100~600 N-m	5 N-m	1015	6200	1 / 2
34522-5DG	14 x 18	10~60 N-m	0.5 N-m	360	1270	1 / 12
34522-6DG	14 x 18	150~800 N-m	5 N-m	1195	6620	1 / 2
34522-7DG	14 x 18	70~350 N-m	2 N-m	580	1800	1 / 12
34522-8DG	14 x 18	200~1000 N-m	5 N-m	1200	6620	1 / 2
34522-9DG	14 x 18	80~400 N-m	2 N-m	580	1780	1 / 12

Single scale - English (in-lb/ft-lb)

KT NO.	Size mm	Torque range in-lb / ft-lb	Incr.	Overall length mm		
34512-1EG	9 x 12	20~100 in-lb	1 in-lb	261	510	1 / 12
34512-2EG	9 x 12	40~200 in-lb	1 in-lb	306	590	1 / 12
34512-3EG	9 x 12	15~80 ft-lb	0.5 ft-lb	430	1270	1 / 12
34522-1EG	14 x 18	15~80 ft-lb	0.5 ft-lb	430	1270	1 / 12
34522-2EG	14 x 18	20~150 lb-ft	1 ft-lb	485	1410	1 / 12
34522-3EG	14 x 18	50~250 ft-lb	1 ft-lb	580	1590	1 / 12

Dual Scale - Newton Meter & English (N-m & in-lb/ft-lb)

KT NO.	Size mm	Torque range N-m	Incr.	Torque range in-lb / ft-lb	Incr.	Overall length mm		
34512-1FG	9 x 12	2~10 N-m	0.1 N-m	22.1~84.1 in-lb	0.9 in-lb	261	510	1 / 12
34512-2FG	9 x 12	4~20 N-m	0.1 N-m	39.8~172.6 in-lb	0.9 in-lb	306	590	1 / 12
34512-3FG	9 x 12	20~100 N-m	0.5 N-m	16.6~71.9 ft-lb	0.4 ft-lb	430	1270	1 / 12
34522-1FG	14 x 18	20~100 N-m	0.5 N-m	16.6~71.9 ft-lb	0.4 ft-lb	430	1270	1 / 12
34522-2FG	14 x 18	40~200 N-m	1 N-m	33.2~143.8 ft-lb	0.8 ft-lb	485	1410	1 / 12
34522-3FG	14 x 18	60~340 N-m	2 N-m	51.6~243.4 ft-lb	1.5 ft-lb	580	1590	1 / 12

Insert Tool

345031

• Chrome plated

- Ratchet insert tool
- Square drive size : 9 x 12
- 5° gear action degree (72 teeth)
- Interchangeable head for interchangeable torque wrenches



- 3426A-1DK
 - 3436A-1DK
 - 3446A-1DK
- series No. before 17086A



- 3426A-1DK01
 - 3436A-1DK01
 - 3446A-1DK01
- series No. after 17086A



- 3426A-1DK02
 - 3436A-1DK02
 - 3446A-1DK02
- series No. after 19106A

345032

• Chrome plated

- Ratchet insert tool
- Square drive size : 14 x 18
- 5° gear action degree (72 teeth)
- Interchangeable head for interchangeable torque wrenches



- 3436A-2DK
 - 3446A-1DK
- series No. before 17086A



- 3466A-1DK
- series No. before 17086A
- 3466A-1DK01
- series No. after 17086A



- 3436A-2DK02
 - 3446A-1DK02
- series No. after 19106A

KT NO.	Size	Maximum Torque N-m	Lw* mm	L mm		
●●● 34503102R	1/4" DR.	62	17.0	46.0	68	12 / 192
●●● 34503103R	3/8" DR.	202	17.6	49.0	99	10 / 160
●●● 34503104R	1/2" DR.	512	25.0	61.9	216	6 / 96

KT NO.	Size	Maximum Torque N-m	Lw* mm	L mm		
●●● 34503203R	3/8" DR.	202	25	70.0	239	6 / 96
●●● 34503204R	1/2" DR.	512	25	70.0	248	6 / 96
●●● 34503206R	3/4" DR.	800	25	71.5	353	4 / 64

345011

• Chrome plated

- Open end insert tool
- Square drive size : 9 x 12

KT NO.	Size mm	Maximum Torque N-m	Lw* mm	L mm		
34501107M	7	10	17.5	37.4	36	12 / 192
34501108M	8	13	17.5	37.9	38	12 / 192
34501109M	9	19	17.5	37.9	38	12 / 192
34501110M	10	25	17.5	38.2	41	12 / 192
34501111M	11	33	17.5	39.0	39	12 / 192
34501112M	12	42	17.5	39.0	41	12 / 192
34501113M	13	52	17.5	39.3	44	12 / 192
34501114M	14	64	20	43.1	54	12 / 192
34501115M	15	77	20	43.4	58	12 / 192
34501116M	16	93	20	43.9	57	12 / 192
34501117M	17	110	20	44.4	61	12 / 192
34501118M	18	130	20	45.3	62	12 / 192
34501119M	19	150	20	45.0	66	12 / 192
34501121M	21	198	25	52.4	118	10 / 160
34501122M	22	225	25	53.1	124	10 / 160
34501124M	24	287	25	54.1	128	8 / 128
34501127M	27	400	32.5	60.1	198	8 / 128
34501130M	30	537	32.5	60.9	195	10 / 80
34501132M	32	644	32.5	62.6	213	10 / 80
34501136M	36	762	32.5	64.8	213	10 / 80

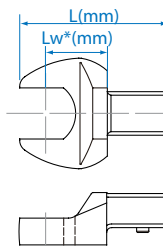



KT NO.	Size inch	Maximum Torque N-m	Lw* mm	L mm		
34501108S	1/4	10	17.5	37.4	36	12 / 192
34501110S	5/16	13	17.5	37.9	38	12 / 192
34501112S	3/8	25	17.5	38.2	40	12 / 192
34501114S	7/16	33	17.5	39.0	41	12 / 192
34501116S	1/2	52	17.5	39.3	43	12 / 192
34501118S	9/16	64	20.0	43.1	53	12 / 192
34501120S	5/8	93	20.0	43.9	59	12 / 192
34501122S	11/16	110	20.0	44.4	63	12 / 192
34501124S	3/4	150	20.0	45.0	64	12 / 192

Insert Tool

345014

• Chrome plated

- Square drive size : 9 x 12

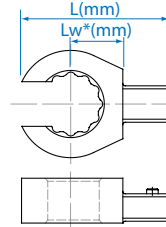

KT NO.	Size mm	Maximum Torque N-m	Lw* mm	L mm		
34501410M	10	25	17.5	42.4	53	12 / 192
34501411M	11	33	17.5	43.0	53	12 / 192
34501412M	12	42	17.5	43.8	53	12 / 192
34501413M	13	52	17.5	43.9	54	12 / 192
34501414M	14	64	17.5	44.3	57.6	12 / 192
34501416M	16	93	17.5	45.0	61	12 / 192
34501417M	17	110	17.5	45.4	62	12 / 192
34501418M	18	130	17.5	46.0	67	12 / 192
34501419M	19	150	17.5	46.7	70	12 / 192
34501421M	21	198	17.5	47.6	72	12 / 192
34501422M	22	225	17.5	48.5	74	12 / 192





345021

• Chrome plated

- Ring insert tool
- Square drive size : 9 x 12

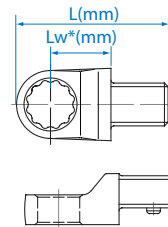
KT NO.	Size mm	Maximum Torque N-m	Lw* mm	L mm		
34502107M	7	26	17.5	39.8	37	12 / 288
34502108M	8	35	17.5	40.5	37	12 / 288
34502110M	10	60	17.5	41.6	40	12 / 288
34502111M	11	73	17.5	43.3	42	12 / 288
34502112M	12	90	17.5	43.8	51	12 / 288
34502113M	13	108	17.5	44.5	52	12 / 288
34502114M	14	128	17.5	45.2	53	12 / 288
34502115M	15	152	17.5	45.9	55	12 / 288
34502116M	16	175	17.5	46.3	57	12 / 288
34502117M	17	202	17.5	47.0	55	12 / 192
34502118M	18	230	17.5	47.4	61	12 / 192
34502119M	19	262	17.5	49.2	63	12 / 192
34502121M	21	330	17.5	50.3	68	12 / 192
34502122M	22	360	17.5	51.2	73	12 / 192





KT NO.	Size inch	Maximum Torque N-m	Lw* mm	L mm		
34502108S	1/4	26	17.5	39.8	38	12 / 288
34502110S	5/16	35	17.5	40.5	37	12 / 288
34502112S	3/8	60	17.5	41.6	42	12 / 288
34502114S	7/16	73	17.5	43.3	42	12 / 288
34502116S	1/2	108	17.5	44.5	52	12 / 288
34502118S	9/16	152	17.5	45.2	53	12 / 288
34502120S	5/8	175	17.5	46.3	58	12 / 288
34502122S	11/16	202	17.5	47.0	62	12 / 192
34502124S	3/4	262	17.5	49.2	65	12 / 192
34502126S	13/16	330	17.5	50.3	72	12 / 192
34502128S	7/8	360	17.5	51.2	70	12 / 192



345012

• Chrome plated

- Open end insert tool
- Square drive size : 14 x 18

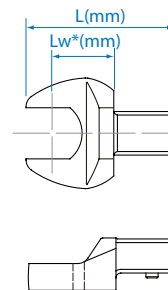
KT NO.	Size mm	Maximum Torque N-m	Lw* mm	L mm		
34501213M	13	52	25	57.5	114	12 / 192
34501214M	14	64	25	58.0	115	12 / 192
34501215M	15	77	25	58.0	118	12 / 192
34501216M	16	93	25	58.5	125	10 / 160
34501217M	17	110	25	59.5	135	10 / 160
34501218M	18	130	25	60.0	134	10 / 160
34501219M	19	150	25	60.5	136	10 / 160
34501221M	21	198	25	61.0	153	6 / 96
34501222M	22	225	25	62.0	158	6 / 96
34501223M	23	255	25	63.1	166	6 / 96
34501224M	24	287	25	63.1	163	6 / 96
34501225M	25	322	25	69.0	162	6 / 96
34501226M	26	359	30	69.0	230	6 / 96
34501227M	27	400	32.5	69.0	239	6 / 96
34501230M	30	537	32.5	70.6	239	6 / 96
34501232M	32	644	32.5	72.1	248	6 / 72
34501234M	34	762	32.5	73.2	246	6 / 72
34501236M	36	800	32.5	73.3	244	6 / 72
34501238M	38	800	32.5	72.7	222	6 / 72
34501240M	40	800	37	80.5	321	6 / 72
34501241M	41	800	37	80.5	315	6 / 72



KT NO.	Size inch	Maximum Torque N-m	Lw* mm	L mm		
34501216S	1/2	52	25	57.5	117	12 / 192
34501218S	9/16	64	25	58.0	121	12 / 192
34501220S	5/8	93	25	58.5	127	10 / 160
34501222S	11/16	110	25	59.5	135	10 / 160
34501224S	3/4	150	25	60.5	140	10 / 160
34501226S	13/16	198	25	61.0	156	6 / 96
34501228S	7/8	225	25	62.0	162	6 / 96
34501230S	15/16	287	25	63.1	168	6 / 96
34501232S	1	322	25	69.0	232	6 / 96
34501236S	1-1/8	537	32.5	70.6	243	6 / 96
34501240S	1-1/4	644	32.5	72.1	242	6 / 96
34501248S	1-1/2	800	32.5	72.7	226	6 / 96

Insert Tool

345022

• Chrome plated

• Square drive size : 14 x 18

KT NO.	Size mm	Maximum Torque N·m	Lw* mm	L mm		
34502213M	13	108	25	62.2	129	12 / 192
34502214M	14	128	25	63.2	128	12 / 192
34502215M	15	152	25	63.3	125	12 / 192
34502216M	16	175	25	63.1	137	12 / 192
34502217M	17	202	25	65.0	134	12 / 192
34502218M	18	230	25	65.0	134	10 / 160
34502219M	19	262	25	66.7	135	10 / 160
34502221M	21	330	25	67.3	151	10 / 160
34502222M	22	368	25	68.5	156	6 / 96
34502224M	24	452	25	69.9	156	6 / 96
34502227M	27	595	31	78.0	201	6 / 96
34502230M	30	762	31	79.6	198	6 / 96
34502232M	32	800	31	81.0	201	6 / 96
34502234M	34	800	31	82.4	225	6 / 90
34502236M	36	800	31	83.7	230	6 / 90
34502241M	41	800	31	86.6	235	6 / 90

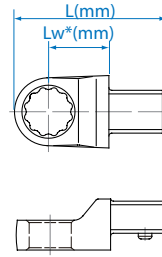

KT NO.	Size inch	Maximum Torque N·m	Lw* mm	L mm		
34502216S	1/2	108	25	62.2	128	12 / 192
34502218S	9/16	128	25	63.2	128	12 / 192
34502220S	5/8	175	25	63.1	132	12 / 192
34502224S	3/4	262	25	66.7	141	10 / 160

34505102R

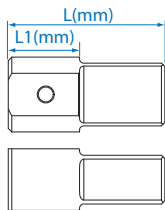

KT NO.	mm	mm	L1 mm	L mm		
34505102R	9 x 12	14 x 18	20.5	45.5	82.2	12 / 144

34505201R

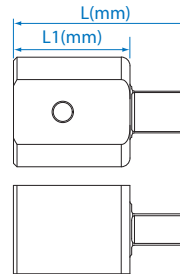

KT NO.	mm	mm	L1 mm	L mm		
34505201R	14 x 18	9 x 12	33.5	49.5	131.8	12 / 144

Hook Wrench Head & Set

345042M

• Square drive size: 14 x 18

KT NO.	Size mm	Capacity mm	Maximum Torque N·m	Lw* mm	L mm		
34504236M	36	28-36	354	77	121	248.20	12 / 72
34504245M	45	40-45	377	77	129	274.00	12 / 72
34504255M	55	50-55	398	77	129	263.20	12 / 72
34504262M	62	58-62	421	77	134	278.20	12 / 72
34504275M	75	68-75	444	77	139	294.60	12 / 72
34504290M	90	80-90	465	77	142	288.80	12 / 72

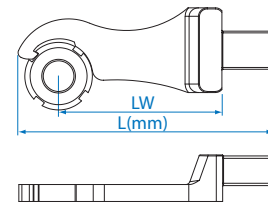

3452407MR

- Suitable for tightening round nuts with radial notches
- Applied with interchangeable torque wrench
- Widely used in automobile, machine tool building and petroleum industries

Contents 2.48 1 / 6

	34505201R	14 x 18(F) → 9 x 12(M)
	345042M	36, 45, 55, 62, 75, 90



7
PC.



Interchangeable Torque Wrench Set

34510

34520



KT NO.	mm	Contents						Kg	Box	
345102D08MR	9 x 12	34512-2DG	4~20 N·m		34503102R	1/4" DR.	345011M	345021M	1.3	1 / 15
345104D08MR		34512-4DG	10~60 N·m		34503103R	3/8" DR.				
345101E08MR		34512-1EG	20~100 in·lb		34503102R	1/4" DR.	10, 13, 17	10, 13, 17	1.2	1 / 15
345102E08MR		34512-2EG	40~200 in·lb		34503102R	1/4" DR.			1.3	1 / 15

KT NO.	mm	Contents						Kg	Box	
345202C11MR	14 x 18	34522-2CG	20~150 ft·lb 34~197 N·m		34503204R	1/2" DR.		13, 14, 15, 17, 19, 22, 24, 27, 30	3.8	1/6
345201D11MR		34522-1DG	20~100 N·m		34503203R	3/8" DR.			3.7	1 / 6
345202D11MR		34522-2DG	40~200 N·m		34503204R	1/2" DR.			3.8	1 / 6
345203D11MR		34522-3DG	60~340 N·m		34503204R	1/2" DR.			4	1 / 6
345201E11MR		34522-1EG	15~80 ft·lb		34503203R	3/8" DR.			3.7	1 / 6
345202E11MR		34522-2EG	20~150 ft·lb		34503204R	1/2" DR.			3.8	1 / 6
345203E11MR		34522-3EG	50~250 ft·lb		34503204R	1/2" DR.			4	1 / 6



Classic Type Adjustable Torque Wrench

Design for easy torque adjustment

Quality accords to DIN ISO 6789:2017 & ASME B107.300-2010

Tolerance of torque $\pm 4\%$ (CW)

CW/CCW Direction

1 N·m = 0.738 ft·lb = 0.102 kgf·m

1 ft·lb = 1.356 N·m = 0.138 kgf·m

1 in·lb = 0.113 N·m = 1.152 kgf·cm

Step:



CW
CCW

Push through mechanism for easy repair

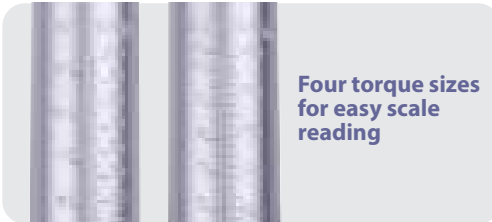

Four torque sizes for easy scale reading

Front Back

CW
CCW

Hidden Rocker-Arm Design:
Pull out the rocker-arm, turn to 90° and stress clockwise for adjusting the requested torque value.

3426E
3436E
3446E

3466E

Step:



- 3436E-1DK
- 3446E-1DK
- 3426E-1DK
- 3466E-1DK

Dual Scale - Newton Meter & English & Kilogram-force meter (N·m / ft·lb / in·lb & kgf·m)

KT NO.	Square drive	Torque range						Overall length mm	g	kg		
		N·m	Incr.	ft·lb	Incr.	in·lb	Incr.				kgf·m	Incr.
● 3426E-1HG	1/4"	2.5~11 N·m	0.5	2~8 ft·lb	1	20~100 in·lb	10	0.3~1.2 kgf·m	0.1	352	630	1 / 12
● 3436E-1HG	3/8"	2.5~11 N·m	0.5	2~8 ft·lb	1	20~100 in·lb	10	0.3~1.2 kgf·m	0.1	352	740	1 / 12
● 3436E-2HG	3/8"	7~33 N·m	1	5~24 ft·lb	1	60~300 in·lb	10	0.7~3.4 kgf·m	0.1	450	870	1 / 12
● 3436E-3HG	3/8"	14~68 N·m	2	10~50 ft·lb	5	125~600 in·lb	25	1.4~7 kgf·m	0.2	505	1210	1 / 12
● 3446E-1HG	1/2"	25~135 N·m	5	20~100 ft·lb	2	200~1200 in·lb	50	3~14 kgf·m	1	555	1640	1 / 12
● 3446E-2HG	1/2"	50~225 N·m	5	40~160 ft·lb	5	400~2000 in·lb	50	5~23 kgf·m	1	590	1710	1 / 12
● 3446E-3HG	1/2"	70~330 N·m	10	50~250 ft·lb	5	600~3000 in·lb	100	7~35 kgf·m	1	803	3440	1 / 6
● 3466E-1HG	3/4"	140~560 N·m	10	100~410 ft·lb	10	1200~5000 in·lb	100	14~57 kgf·m	1	977	8480	1 / 2
● 3466E-2HG	3/4"	200~800 N·m	20	150~600 ft·lb	20	1800~7200 in·lb	200	22~82 kgf·m	2	1033	8860	1 / 2

Window Type Adjustable Torque Wrench

Adjustable torque wrench with window dual scale

Tolerance of torque $\pm 3\%$ clockwise

Dual scale in N-m and ft-lb conversion table on window

Grip handle and large number NM on center handle for setup required torque

Simple lock and unlock knob for quick in adjustment

Durable mechanism with over 10,000 cycles within accuracy

Quality accords to DIN ISO 6789:2017 & ASME B107.300-2010

The 3/4" torque wrenches have a cylinder body

1 N-m = 0.738 ft-lb = 0.102 kgf-m

1 ft-lb = 1.356 N-m = 0.138 kgf-m

1 in-lb = 0.113 N-m = 1.152 kgf-cm



Dual Scale - Newton Meter & English (N-m / ft-lb)

KT NO.	Gear teeth	Square drive	Torque range N-m	Incr.	Torque range ft-lb	Overall length mm		
● 34266-1FG	24	1/4"	5-25 N-m	0.1 N-m	3.6-18 ft-lb	296	410	1 / 12
● 34366-1FG	32	3/8"	10-50 N-m	0.25 N-m	7.4-37 ft-lb	333	470	1 / 12
● 34466-1FG	32	1/2"	20-100 N-m	0.5 N-m	15-75 ft-lb	398	820	1 / 12
● 34466-2FG	32	1/2"	40-200 N-m	1 N-m	30-150 ft-lb	500	1300	1 / 12
● 34466-3FG	32	1/2"	60-300 N-m	1 N-m	45-220 ft-lb	633	1470	1 / 12
● 34666-1FG	24	3/4"	100-600 N-m	2 N-m	75-440 ft-lb	1040	4650	1 / 2
● 34666-2FG	24	3/4"	150-800 N-m	2 N-m	110-590 ft-lb	1235	5450	1 / 2
● 34666-3FG	24	3/4"	200-1000 N-m	2 N-m	150-740 ft-lb	1238	5450	1 / 2

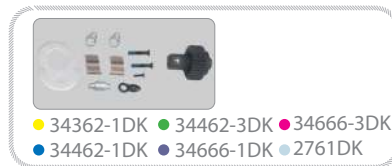

- CAUTION**
1. Do not use this torque wrench over its scale range.
 2. Do not use this torque wrench as a normal hand tool.
 3. Torque wrench need to be calibrated periodically for accuracy.



Click Type Adjustable Torque Wrench

Industrial application with durability
 Loud click sound and strong impulse when required torque is reached
 Tolerance of torque $\pm 3\%$ (CW)
 Quality accords to DIN ISO 6789:2017 & ASME B107.300-2010
 Ideal for using on oily, chemical and noisy assembling working field
 CW/CCW Direction

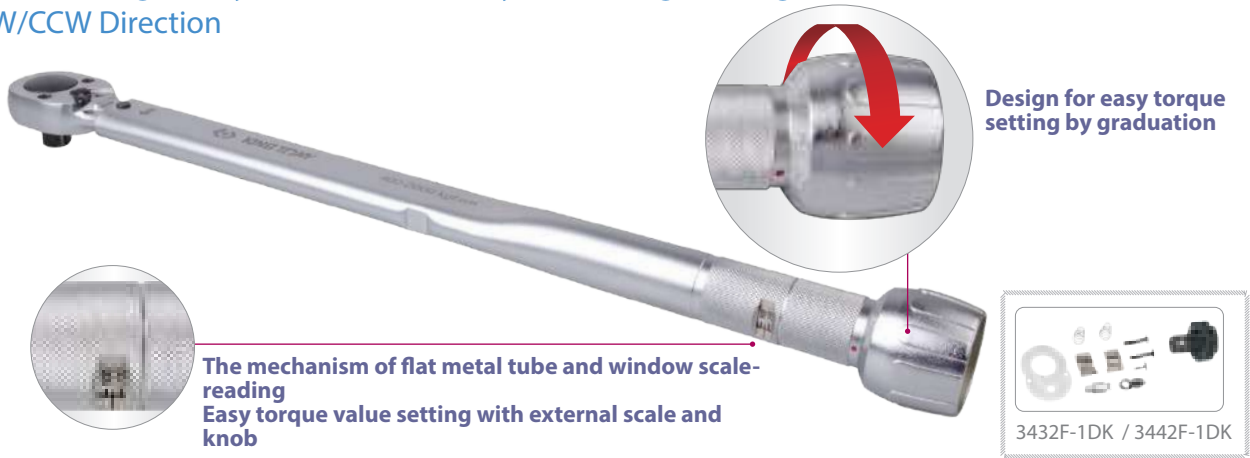

Dual Scale - Kilogram-force Centimeter(kgf-cm)

KT NO.	Gear teeth	Square drive	Torque range kgf-cm	Incr.	Overall length mm		
3432F-1KF	24	3/8"	50-250 kgf-cm	2.5 kgf-cm	240	450	1 / 24
3432F-3KF	24	3/8"	200-1000 kgf-cm	10 kgf-cm	342	800	1 / 12
3442F-1KF	24	1/2"	200-1000 kgf-cm	10 kgf-cm	342	800	1 / 12
3442F-3KF	24	1/2"	400-2000 kgf-cm	20 kgf-cm	498	1500	1 / 12

Adjustable Torque Wrench

Design for easy torque adjustment
 Quality accords to DIN ISO 6789:2017 & ASME B107.300-2010
 Tolerance of torque $\pm 4\%$ (CW)
 CW/CCW Direction



- The production of injection molding helps it against come off
- One hand operation
- Quick torque set
- Automatic torque locking

Dual Scale - Newton Meter & English (N-m / ft-lb)

KT NO.	Gear teeth	Square drive	Torque range N-m / ft-lb	Incr.	Overall length mm		
34464-1FG	24	1/2"	40-210 N-m (33.2-151.2 ft-lb)	1.0 N-m	470	1250	1 / 12
34464-2FG	24	1/2"	70-340 N-m (62.7-239.7 ft-lb)	3.0 N-m	590	1590	1 / 12

Adjustable Torque Wrench

Quality accords to DIN ISO 6789:2017 & ASME B107.300-2010

Tolerance of torque $\pm 4\%$ (CW)

CW/CCW Direction

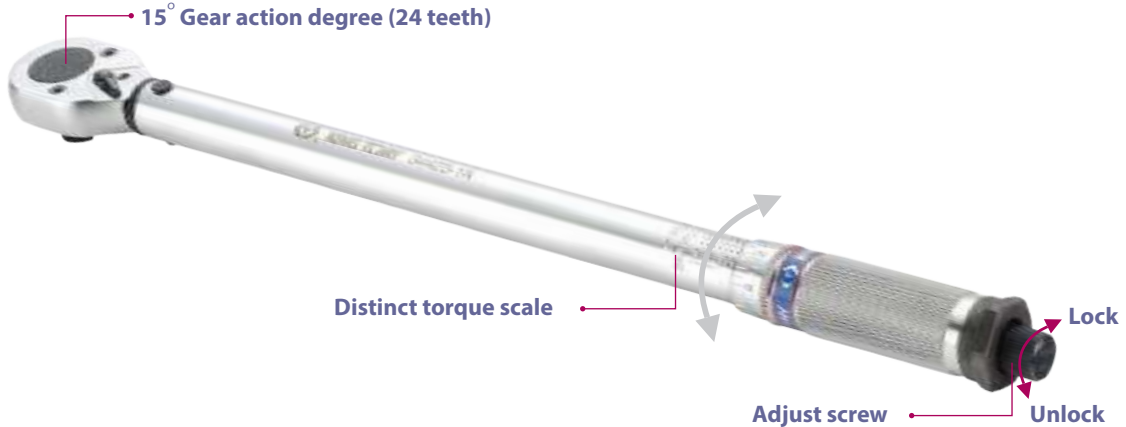

Dual Scale - Newton Meter & Kilogram-force Centimeter / Kilogram-force meter (N-m & kgf-cm / kgf-m)

KT NO.	Square drive	Torque range N-m	Incr.	Torque range kgf-cm / kgf-m	Incr.	Overall length mm		
● 34223-1A	1/4"	5~25 N-m	0.1 N-m	51~255 kgf-cm	1 kgf-cm	280	595	1 / 12
● 34323-1A	3/8"	5~25 N-m	0.1 N-m	51~255 kgf-cm	1 kgf-cm	280	595	1 / 12
● 34323-2A	3/8"	20~110 N-m	1 N-m	2.04~11.22 kgf-m	0.1 kgf-m	370	820	1 / 12
● 34423-1A	1/2"	42~210 N-m	1 N-m	4.3~21.4 kgf-m	0.41 kgf-m	450	1340	1 / 12
● 34423-2A	1/2"	70~340 N-m	3 N-m	7.1~34.7 kgf-m	0.27 kgf-m	570	2400	1 / 12

Dual Scale - English & Kilogram-force Centimeter / Kilogram-force meter (in-lb / ft-lb & kgf-cm / kgf-m)

KT NO.	Square drive	Torque range in-lb / ft-lb	Incr.	Torque range kgf-cm / kgf-m	Incr.	Overall length mm		
● 34223-1B	1/4"	55~250 in-lb	1.5 in-lb	63~288 kgf-cm	1.13 kgf-cm	280	595	1 / 12
● 34323-1B	3/8"	55~250 in-lb	1.5 in-lb	63~288 kgf-cm	1.13 kgf-cm	280	595	1 / 12
● 34323-2B	3/8"	15~80 ft-lb	0.5 ft-lb	2.1~11.10 kgf-m	0.07 kgf-m	370	820	1 / 12
● 34423-1B	1/2"	30~150 ft-lb	1 ft-lb	4.2~20.8 kgf-m	0.14 kgf-m	450	1340	1 / 12
● 34423-2B	1/2"	50~250 ft-lb	2 ft-lb	6.9~34.6 kgf-m	0.27 kgf-m	570	2400	1 / 12

Dual Scale - Newton Meter & English (N-m & in-lb / ft-lb)

KT NO.	Square drive	Torque range in-lb / ft-lb	Incr.	Torque range N-m	Incr.	Overall length mm		
● 34223-1C	1/4"	55~250 in-lb	1 in-lb	6.2~28.2 N-m	0.17 N-m	280	595	1 / 12
● 34323-1C	3/8"	55~250 in-lb	1 in-lb	6.2~28.2 N-m	0.17 N-m	280	595	1 / 12
● 34323-2C	3/8"	15~80 ft-lb	0.5 ft-lb	20.3~108.5 N-m	0.68 N-m	370	820	1 / 12
● 34423-1C	1/2"	30~150 ft-lb	1 ft-lb	40.7~203.4 N-m	1.35 N-m	450	1658	1 / 12
● 34423-2C	1/2"	50~250 ft-lb	2 ft-lb	67.8~339 N-m	2.71 N-m	570	2400	1 / 12

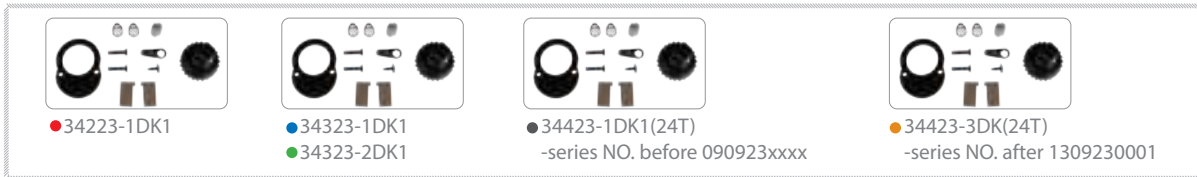

Adjustable Torque Wrench Set

344251A12MR

1/2"

Blow case size (mm) :
500 x 125 x 70 (0.15cuft)

Contents

2.85 1 / 10

	34423-1A	42~210 N-m
	4335MR	13, 14, 15, 16, 17, 18, 19, 21, 22, 24
	4251-04R	



12
PC.



Heavy Duty Adjustable Aluminum Torque Wrench

Industrial application

Lightweight and robust housing made by aluminium alloy

Multi-lever mechanism brings length independence and accurate torque

Loud click sound and string impulse when torque value reached

Easy lock and adjustment design

Tolerance of torque $\pm 3\%$ (CW)

Quality accords to DIN ISO 6789:2017 & ASME B107.300-2010



Clear dual scale

Pull out the Rocket-Arm, turn to 90° and stress clockwise for adjusting the requested torque value



Aluminium housing and ergonomically designed handgrip

Step:

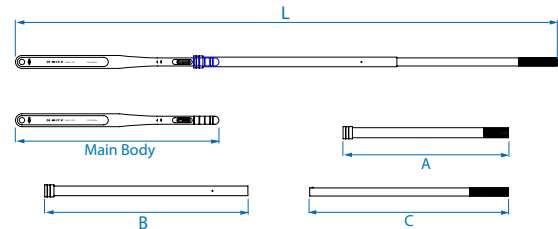
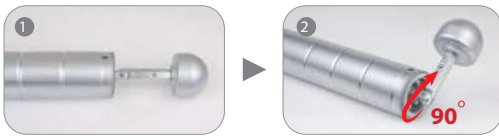

Dual Scale - Newton Meter & English (N-m & ft-lb)

KT NO.	Square drive	Torque range			Main Body	A	B	C	Overall length mm	kg	/ /
		N-m	Incr.	ft-lb							
3445G-1FB	1/2"	40~200 N-m	5	30~150 ft-lb	5	563	-	-	563	1.50	1 / 12
3465G-1FB	3/4"	110~550 N-m	10	80~400 ft-lb	10	827	-	-	827	3.00	1 / 2
3465G-2FB	3/4"	140~760 N-m	10	100~560 ft-lb	10	827	-	-	827	3.00	1 / 2
3465G-3FB	3/4"	200~1000 N-m	10	140~740 ft-lb	10	808	762	-	1413	3.80	1 / 2
3485G-1DB	1"	600~1500 N-m	25	-	-	945	-	771	1615	10.90	1 / 1
3485G-2DB	1"	750~2000 N-m	50	-	-	947	-	945	2370	16.30	1 / 1

Torque Angle Adapter

34417-1A

▪ Specifications:

Accuracy	Clockwise:±2% Anti-Clockwise:±2%				
Memory	10				
Unit Selection	N·m	ft·lb	In·lb	Kgf·m	Kgf·cm
Display Resolution	0.1	0.1	1	0.01	1
Operation Mode	Torque / Angle / Torque+Angle				
Battery	DC3V, CR2032				
Battery Life	4hrs (continuous operation)				
Operating Ambient Temperature	-10°C - 60°C (14°F - 140°F)				
Storage Temperature	-20°C - 70°C (-4°F - 158°F)				
Operating Relative Humidity	15 to 90% noncondensing				
Switch Off Automatically	100 seconds				
Warning Light	Green, Yellow, Red				
Overload Alarm	240 N·m (177 ft·lb)				



4 PC.

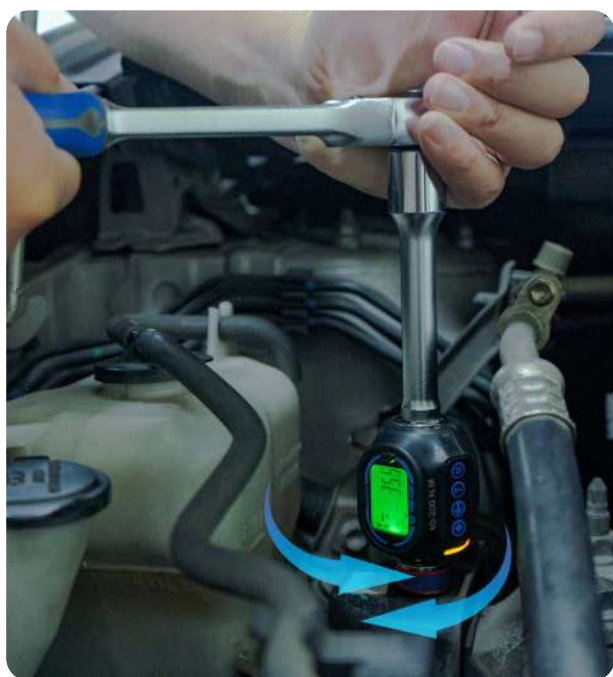

Calibration adapter

1/2" x 3/8" 1/2" x 1/4"



Torque Angle Adapter



• The LED screen is backlit for easier reading

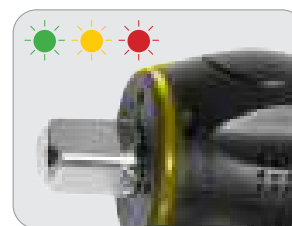

• The ring-shaped warning light can provide an immediate visual cue for the torque values

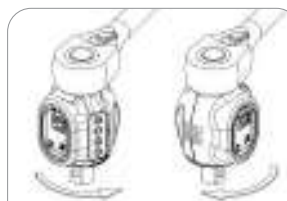

Right ANG/F 120° Left ANG/F 120°

• The body can be rotated 240° for easier reading

Dual Scale - Newton Meter & English & Kilogram-force meter (N·m / ft·lb & kgf·m)

KT NO.	Square drive	Torque range				
		N·m	ft·lb	kgf·m		
34417-1A	1/2"	40 ~200 N·m	29.5~147.5 ft·lb	4.08~20.38 kgf·m	620	1 / 12



Electronic Torque Wrench



- Electronic torque value readout
- Peak and trace mode selection
- Buzzer and LED indicator for presetting target torque
- Engineering units (N·m, ft·lb, in·lb, kgf·m) adjustment
- Switch off automatically after 60 seconds
- DIN ISO 6789:2017 & ASME B107.300-2010
- CW \pm 2% and CCW \pm 2.5% operation



Display :
LCD display (\pm 2 digit) with measuring ranges that can be selected for N·m, ft·lb, in·lb, kg·m



Signal :
3-way signal when the maximum torque value is reached, as a result the wrench can be used in noisy places.

LED warning light

• Electronic Torque Wrench

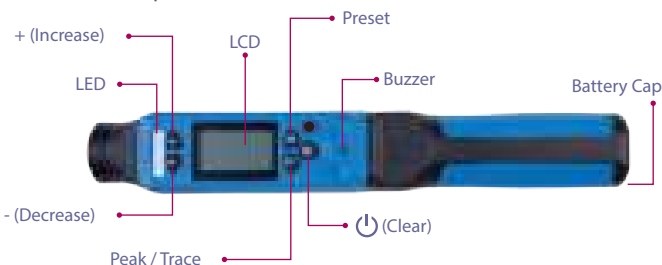

Torque Accuracy	CW \pm 2% / CCW \pm 2.5%
Preset Function	10
Display Resolution	0.1 N·m/ ft·lb , 1.0 in·lb, 0.01 kgf·m
Operation Mode	Peak/Trace
Battery	AAAx3
Backlight	Yes (Negative)
Alert	LED & Buzzer
Operating Ambient Temperature	-10°C ~ 60°C
Storage Temperature	-20°C ~ 70°C
Operation Relative Humidity	15 to 90% noncondensing



Dual Scale - Newton Meter & English & Kilogram-force meter (N·m / in·lb / ft·lb & kgf·m)

KT NO.	Gear teeth	Square drive	Torque range				Overall length mm	g	kg
			N·m	in·lb	ft·lb	kgf·m			
• 34367-2AG	72	3/8"	27-135 N·m	239~1195 in·lb	19.9-99.6 ft·lb	2.75~13.76 kgf·m	460	1400	3 / 6
• 34467-1AG	36	1/2"	40-200 N·m	354~1770 in·lb	29.5-147.5 ft·lb	4.08~20.38 kgf·m	530	1500	3 / 6

Electronic Torque Adapter

34207-1A

34307-1A

34407-1A



Specifications:

Accuracy	± 2%
Memory	50
Display Resolution	0.1 N·m /ft·lb ,0.01 kgf·m
Operation Mode	Peak/Trace
Unit Selection	kgf·m, ft·lb, N·m
Battery	AAA x 2 PC.
Battery Life	110hrs (continuous operation)
Operating Ambient Temperature	-10°C - 60°C (13.9°F - 139.9°F)
Storage Temperature	-20°C - 70°C (-4°F - 157.9°F)
Operating Relative Humidity	15 to 90% noncondensing
Switch Off Automatically	70 seconds (if do not use electronic torque adapter.)
LED Indicator	Green, Red
Overload Alarm	34207-1A: 37.5 N·m (27.6 ft·lb) 34307-1A: 168.8 N·m(124.5 ft·lb) 34407-1A: 250 N·m (184.4 ft·lb)



Dual Scale - Newton Meter & English & Kilogram-force meter (N·m / ft·lb & kgf·m)

KT NO.	Square drive	Torque range			Size mm		
		N·m	ft·lb	kgf·m			
34207-1A	1/4"	6~30 N·m	4.4~22.1 ft·lb	0.61~3.06 kgf·m	L75 x W45 x H40	124	12 / 48
34307-1A	3/8"	27~135 N·m	19.9~99.6 ft·lb	2.75~13.76 kgf·m	L75 x W45 x H40	198	12 / 48
34407-1A	1/2"	40~200 N·m	29.5~147.5 ft·lb	4.08~20.38 kgf·m	L75 x W45 x H40	199	12 / 48

34407T-1A

Accuracy	± 2%
Memory	50
Display Resolution	0.1 N·m /ft·lb ,0.01 kgf·m 1Psi /0.001 Bar /0.001 kgf·cm ² /0.01 Kpa
Operation Mode	Peak/Trace
Unit Selection	in·lb, ft·lb, Kgf·m, Kgf·cm, N·m Kpa, Bar, psi, kgf·cm ²
Battery	AAA x 2 PC.
Battery Life	50hrs (continuous operation)
Operating Ambient Temperature	-10°C - 60°C (13.9°F - 139.9°F)
Storage Temperature	-20°C - 70°C (-4°F - 157.9°F)
Operating Relative Humidity	15 to 90% noncondensing
Auto Shut Off	60 seconds



Dual Scale - Newton Meter & English & Kilogram-force meter (N·m / lbf·ft & kgf·m)

KT NO.	Square drive	Torque range			Pressure range	Size mm		
		N·m	ft·lb	kgf·m				
34407T-1A	1/2"	40~200 N·m	29.5~147.5 ft·lb	4.08~20.38 kgf·m	1-100 psi (0.069~6.6bar)	L75 x W67 x H46 mm	343	1 / 24



Electronic Torque Adapter

34607-1A



Specifications:

Accuracy	± 2%
Memory	50
Display Resolution	0.1 N-m / ft-lb , 0.01 kgf-m
Operation Mode	Peak/Trace
Unit Selection	kgf-m, ft-lb, N-m
Battery	AA x 2 PC.
Battery Life	110hrs (continuous operation)
Operating Ambient Temperature	-10°C - 60°C (13.9°F - 139.9°F)
Storage Temperature	-20°C - 70°C (-4°F - 157.9°F)
Operating Relative Humidity	15 to 90% noncondensing
Switch Off Automatically	70 seconds (if do not use electronic torque adapter.)
LED Indicator	Green. Red
Overload Alarm	1250 N-m (922 ft-lb)

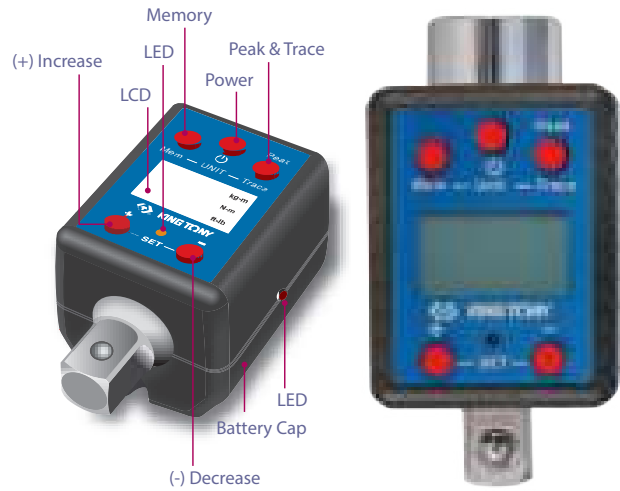

Dual Scale - Newton Meter & English & Kilogram-force meter (N-m / ft-lb & kgf-m)

KT NO.	Square drive	Torque range			Size mm	g	/ /
		N-m	ft-lb	kgf-m			
34607-1A	3/4"	200 ~1000 N-m	147.6~738 ft-lb	20.4~102 kgf-m	L110 x W56 x H60	585	6 / 24

Torque Screwdriver

34211

- Suitable for 1/4" Hex insert bit; 1/4" socket
- Automatic adjustment knob design
- Easy-to-read laser scale
- Ergonomic comfort rubber grip
- Tolerance of torque ± 5%(CW)
- Quality meets DIN ISO 6789:2017 & ASME B107.300-2010



► Quick-Release

34011

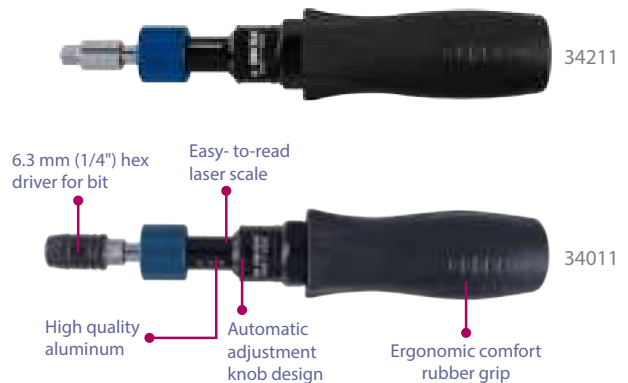

KT NO.	Spec.	Torque range cN-m / N-m / in-lb	Incr.	Overall length mm	g	/ /
34211-3DG	⊙	4~9 N-m	0.1 N-m	196	475	1 / 24
34011-1DG	○	30~120 cN-m	1 cN-m	180	207	1 / 24
34011-1EG	○	3~15 in-lb	0.1 in-lb	180	207	1 / 24
34011-2DG	○	1.5~6.5 N-m	0.1 N-m	196	475	1 / 24
34011-2EG	○	10~50 in-lb	1.0 in-lb	196	475	1 / 24

Torque Angle Gauge

34440

34440A

34660

34660A

- Square Drive :
34440 (1/2" x 1/2")
34660 (3/4" x 3/4")
- 360° angle scale- clearly marked in 2° increments, and in intervals of 10° and 30°
- Indicator etched on clear plastic plate, protects angle scale from dirt and grease
- Adjustable arm keeps angle scale stationary
- Arm has two lengths for additional flexibility in placement against components
- Tough composite dial and rotating index allow operator to accurately tighten to meet standard

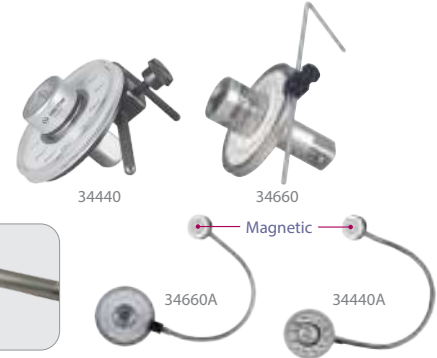

KT NO.	Spec.		
34440	1/2"F x 1/2"M	190	12 / 48
34440A	1/2"F x 1/2"M	375	6 / 24
34660	3/4"F x 3/4"M	666	6 / 12
34660A	3/4"F x 3/4"M	908	6 / 12



• Step 1 : Set up the torque value by torque wrench



• Step 2 : Adjust the angle by angle gauge

Torque Multiplier

34486

34488

34688

- Torque multiplication with 5:1, accuracy guaranteed better than $\pm 5\%$
- Reaction bar supplied in two styles for maximum versatility
- Ideal construction offers minimal maintenance and extended life
- Portable package brings convenience for use in different working places

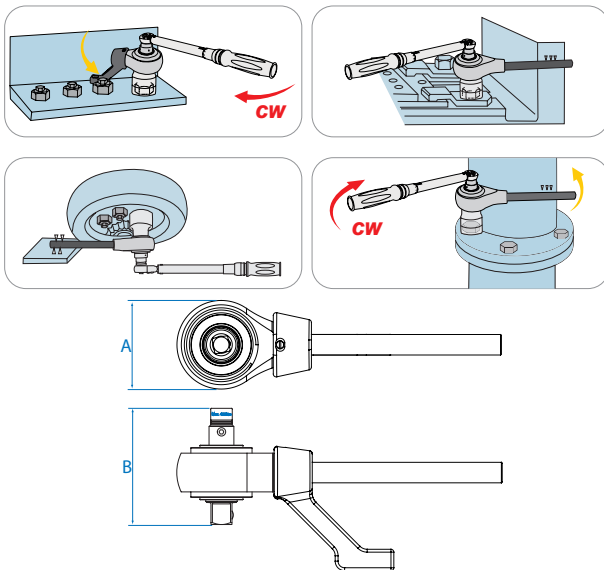

Contents

	34486-05A 34488-05A 34688-05A	Multiplier head	1 PC.
	34688-P01	Reaction bar	1 PC.
	34688-P02	Reaction bar	1 PC.
	34486-P03 34488-P03 34688-P03	Torque-Limit Adapter	1 PC.

KT NO.	Ratio	Input square	Output square	Max input torque N-m / ft-lb	Max output torque N-m / ft-lb	A mm	B mm		
34486	5 : 1	1/2"	3/4"	300 / 220	1500 / 1100	108	136.3	7.1	1 / 2
34488	5 : 1	1/2"	1"	400 / 290	2000 / 1450	108	140.3	7.5	1 / 2
34688	5 : 1	3/4"	1"	540 / 400	2700 / 2000	108	161.0	7.7	1 / 2





Torque Multiplier

34488-26



- Torque multiplication with 26:1, accuracy guaranteed better than $\pm 5\%$
- Reaction bar supplied in two styles for maximum versatility
- High ratios offers an idea to replace long lever arm and heavy wrench
- Ideal construction offers minimal maintenance and extended life
- Portable package brings convenience for use in different working places
- Anti-backlash device



Contents

-  Multiplier head 1 PC.
-  Reaction bar 2 PC.



KT NO.	Ratio	Input square	Output square	Max input torque N-m / ft-lb	Max output torque N-m / ft-lb		
34488-26	26 : 1	1/2"	1"	175 / 130	4500 / 3300	15.7	1 / 1







Universal Torque Converter Set

3488A03MP



- It is a newly designed wheel wrench for truck or car tires by using less labor to reach a sufficient output torque
- Suitable for trucks, buses, and other heavy duty vehicles

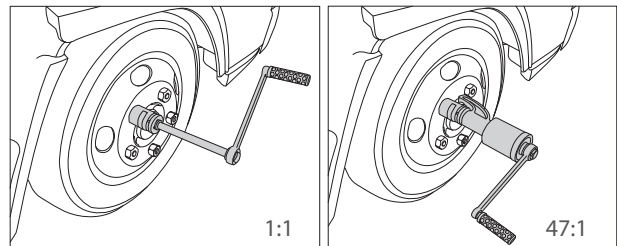

Contents

	Power enhanced device 1 PC.
	Prolonged pole 1 PC.
	Handle 1 PC.
	32, 33



KT NO.	Ratio	Input square	Output square	Max output torque N·m / ft·lb		
3488A03MP	47 : 1	1"	1"	4700 / 3466	9.3	1 / 2







Torque Tester

ZV011

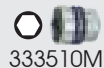
 7.7  /  1 / 1

Calibration Range	2~60 N·m
Accuracy	± 0.5%
Units of Measurement	in·lb, ft·lb, Kgf·m, Kgf·cm, N·m, N·cm
Input Hex A/F (mm)	10mm
Square Drive Adaptor (inch)	1/4", 3/8", 1/2"
Operating Temperature Range	+5°C~ +40°C
Storage Temperature Range	+0°C~ +70°C
Power Input	100-240V DC9.0V \pm 1.66A, 15W MAX
Base Material / Finish	Aluminum Alloy / Painting
Dimension	210(L) x 150(W) x 140(H) mm







ZV011A		Europe
ZV011B		America & Asia
ZV011D		Australia & New Zealand

ZV012

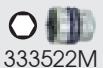
 8.1  /  1 / 1

Calibration Range	8~400 N·m
Accuracy	± 0.5%
Units of Measurement	in·lb, ft·lb, Kgf·m, Kgf·cm, N·m, N·cm
Input Hex A/F (mm)	22mm
Square Drive Adaptor (inch)	3/8", 1/2", 3/4"
Operating Temperature Range	+5°C~ +40°C
Storage Temperature Range	+0°C~ +70°C
Power Input	100-240V DC9.0V \pm 1.66A, 15W MAX
Base Material / Finish	Aluminum Alloy / Painting
Dimension	210(L) x 150(W) x 140(H) mm





ZV012A		Europe
ZV012B		America & Asia
ZV012D		Australia & New Zealand

ZV013

 8.9  /  1 / 1

Calibration Range	100~1500 N·m
Accuracy	± 0.5%
Units of Measurement	in·lb, ft·lb, Kgf·m, Kgf·cm, N·m
Input Hex A/F (mm)	36mm
Square Drive Adaptor (inch)	3/4"
Operating Temperature Range	+5°C~ +40°C
Storage Temperature Range	+0°C~ +70°C
Power Input	100-240V DC9.0V \pm 1.66A, 15W MAX
Base Material / Finish	Aluminum Alloy / Painting
Dimension	210(L) x 150(W) x 140(H) mm



ZV013A		Europe
ZV013B		America & Asia
ZV013D		Australia & New Zealand



TORQUE CONTROL & MULTIPLIERS

WRENCHES





Ø12mm - 28mm

19

3134

KING TONY



19



KING TONY

3616S-08P

80-89

KING TONY UNIT DRIVE Profile

1. A large contact surface provides a secure force closure even for bolts whose sizes are out of the tolerances.
2. Radiate distribution of the force on the bolt flanks, reducing notch effect, which prevents the bolt from being rounded.
3. Gentle torque transfer enables worn bolts to be loosened.
4. Optimally distributed force up to 20 % higher torques can be transferred.

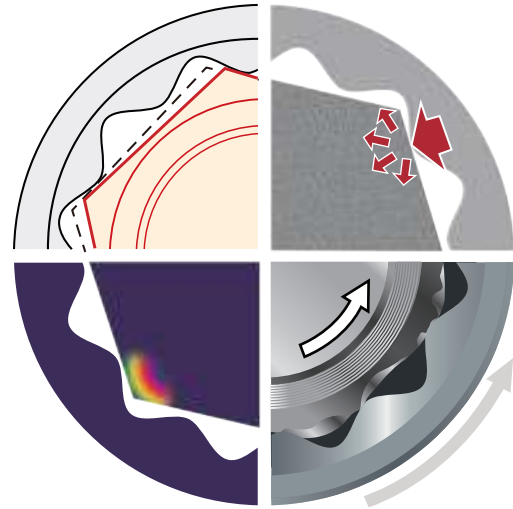

The KING TONY UNIT DRIVE prevents the bolts from being damaged by using of a wave form without any tipped or sharp edges. Enlarged, round contact surfaces ensure that torque is reliably transferred - acting radiately, as it does, on the bolt. Minimising notch effect prevents any damage to the bolt.

Wrench Made

- 1 Raw material
- 2 Hot forge
- 3 Barreling
- 4 Polishing
- 5 Punching & Broaching
- 6 Marking
- 7 Heat treatment
- 8 Vibrating
- 9 Sand blast
- 10 Plating

Advanced structure saves time

There are more and more improved tool structures come out every year. King Tony selects useful idea and engineering function on developing new product within quality and economic concern. Every piece of component is designed for the comfort to users.

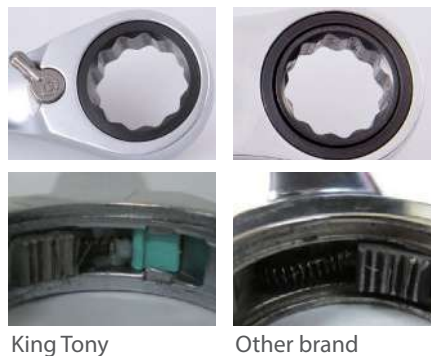

King Tony

Other brand

Exceed other brands **20%**

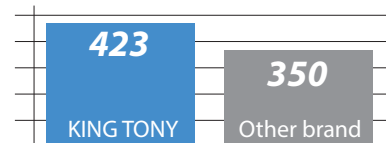

KING TONY speed wrench is 20% stronger than others.

Ultra-Light & Long Combination Wrench & Set

KT No. & D1



1061

PAT.

- New forge technologies I-Beam shank offers 20% lightweight and better strength
- 15° open slimline type
- 13° ring end offset from shaft
- Chrome vanadium alloy steel
- Chrome plated
- DIN 3113 from A / ISO 7738

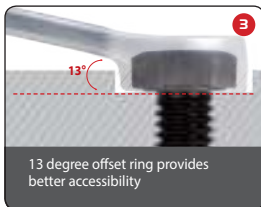
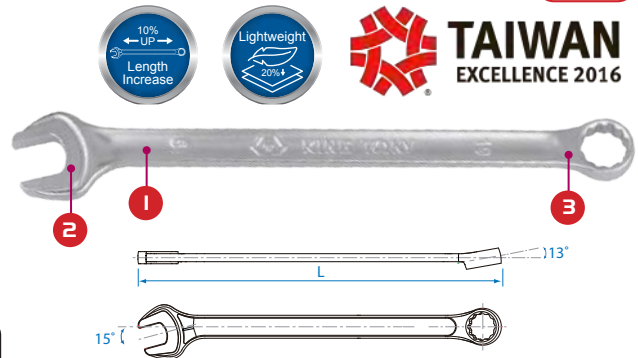

KT NO.	Size mm	L mm	⚖️	📦
1061-06	6	128	19	12 / 768
1061-07	7	148	31	12 / 576
1061-08	8	148	29	12 / 576
1061-09	9	167	46	12 / 384
1061-10	10	167	47	12 / 384
1061-11	11	186	58	12 / 240
1061-12	12	196	62	12 / 192
1061-13	13	205	85	12 / 192
1061-14	14	223	101	12 / 120
1061-15	15	233	121	12 / 144
1061-16	16	243	135	12 / 144
1061-17	17	262	168	12 / 96
1061-18	18	272	187	12 / 96

KT NO.	Size mm	L mm	⚖️	📦
1061-19	19	281	203	12 / 96
1061-20	20	301	273	8 / 48
1061-21	21	301	269	8 / 48
1061-22	22	319	304	8 / 48
1061-23	23	319	301	8 / 48
1061-24	24	338	370	5 / 40
1061-25	25	358	450	5 / 40
1061-26	26	358	431	5 / 40
1061-27	27	383	510	5 / 40
1061-28	28	383	508	5 / 40
1061-29	29	408	617	5 / 20
1061-30	30	408	599	5 / 20
1061-32	32	433	789	5 / 20



► Pouch material : Tetoron

KT NO.	PC.	Contents	⚖️	📦
12C7MRN01	7	8, 10, 12, 13, 14, 17, 19	0.77	1 / 24
12C8MRN	8	6, 7, 8, 9, 10, 11, 12, 13	0.77	1 / 24
12A0MRN	10	10, 11, 12, 13, 14, 15, 16, 17, 18, 19	1.35	1 / 12
12A1MRN	11	 1061 8, 10, 12, 13, 14, 16, 17, 18, 19, 22, 24	2.06	1 / 12
12A3MRN	13	8, 10, 11, 12, 13, 14, 15, 16, 17, 18, 19, 22, 24	2.16	1 / 12
12A4MRN	14	8, 10, 11, 12, 13, 14, 15, 16, 17, 18, 19, 21, 22, 24	2.44	1 / 8
12B4MRN	24	6, 8, 10, 11, 12, 13, 14, 15, 16, 17, 18, 19, 20, 21, 22, 23, 24, 25, 26, 27, 28, 29, 30, 32	7	1 / 2



WRENCHES

Combination Wrench



1062 PAT.



New slimline I-Beam shank offers superior strength with less effort



More powerful open end with big thumb point delivers more torque

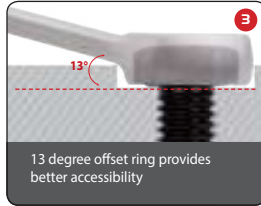

13 degree offset ring provides better accessibility

- 15° open end reinforcement design in slim profile
- 13° ring end high relief zone design with thin wall access ability
- Chrome vanadium alloy steel
- Metric - DIN 3113 from A, ISO 7738



KT NO.	Size mm	L mm		
1062-06	6	105	17	12 / 504
1062-07	7	115	19	12 / 504
1062-08	8	125	27	12 / 504
1062-09	9	135	28	12 / 504
1062-10	10	145	36	12 / 504
1062-11	11	155	45	12 / 504
1062-12	12	165	58	12 / 216
1062-13	13	175	73	12 / 216
1062-14	14	185	88	12 / 216
1062-15	15	195	94	12 / 192
1062-16	16	205	108	12 / 192
1062-17	17	215	129	12 / 192
1062-18	18	225	151	12 / 144

KT NO.	Size mm	L mm		
1062-19	19	235	159	12 / 144
1062-20	20	245	186	12 / 144
1062-21	21	255	203	12 / 96
1062-22	22	265	221	12 / 96
1062-23	23	275	262	12 / 96
1062-24	24	285	281	6 / 54
1062-25	25	295	309	6 / 54
1062-26	26	305	343	6 / 54
1062-27	27	315	393	6 / 54
1062-28	28	325	416	6 / 48
1062-29	29	335	456	6 / 48
1062-30	30	345	491	6 / 48
1062-32	32	365	573	6 / 48

Combination Wrench Set



► MRN / SRN : Teton pouch bag



Protection cover

► 12D21MRN

KT NO.	PC.	Contents	Package		
12D09MRN	9	8, 9, 10, 11, 12, 13, 14, 17, 19	Teton	0.80	1 / 24
12D10MRN	10	8, 10, 12, 13, 14, 17, 19, 21, 22, 24	Teton	1.44	1 / 16
12D13MRN	13	6, 8, 10, 11, 12, 13, 14, 15, 17, 19, 21, 22, 24	Teton	1.68	1 / 12
12D14MRN05	14	6, 7, 8, 9, 10, 11, 12, 13, 14, 15, 16, 17, 18, 19	Teton	1.27	1 / 12
12D15MRN	15	10, 11, 12, 13, 14, 15, 16, 17, 19, 21, 22, 24, 27, 30, 32	Teton	3.32	1 / 8
12D15MRN01	14	8, 10, 11, 12, 13, 14, 15, 16, 17, 18, 19, 21, 22, 24	Teton	1.96	1 / 12
12D18MRN	18	6, 7, 8, 9, 10, 11, 12, 13, 14, 15, 16, 17, 18, 19, 20, 21, 22, 24	Teton	2.36	1 / 8
12D21MRN	21	6, 7, 8, 9, 10, 11, 12, 13, 14, 15, 16, 17, 18, 19, 20, 21, 22, 24, 27, 30, 32	Teton	4.10	1 / 6
12D26MRN	26	6, 7, 8, 9, 10, 11, 12, 13, 14, 15, 16, 17, 18, 19, 20, 21, 22, 23, 24, 25, 26, 27, 28, 29, 30, 32	Teton	5.20	1 / 4

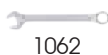

Portable Wrench Set

12D06MRS

KT NO.	PC.	Contents	Package		
12D06MRS	6	 1062 10, 12, 13, 14, 17, 19	color box	0.82	1 / 16

6
PC.



Portable Wrench Set



- Easy to recognize
- One-handed carry











- Quick storage
- Elastic structure design
- Hanging hole

12
PC.

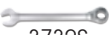

- Wrench safely locked in support

KT NO.	PC.	Contents	Package		
12A2MRS02	12	 8, 10, 11, 12, 13, 14, 15, 16, 17, 18, 19, 22	color box	1.8	1 / 8
12A09MRS01	9	 1061 6, 8, 10, 11, 13, 14, 15, 17, 19	color box	1.20	1 / 20
12D12MRS	12	8, 9, 10, 11, 12, 13, 14, 16, 17, 18, 19, 22	color box	1.4	1 / 12
12D12MRS01	12	 1062 8, 9, 10, 11, 12, 13, 14, 16, 17, 18, 19, 21	color box	1.4	1 / 12
12D09MRS01	9	6, 8, 10, 11, 13, 14, 15, 17, 19	color box	0.85	1 / 24
12112MRS02	12	 8, 10, 11, 12, 13, 14, 15, 16, 17, 18, 19, 22	color box	1.6	1 / 12
12109MRS01	9	 3731M 8, 10, 11, 12, 13, 14, 15, 17, 19	color box	0.95	1 / 24
122A12MRS02	12	 8, 10, 11, 12, 13, 14, 15, 16, 17, 18, 19, 22	color box	1.6	1 / 12
122A09MRS01	9	 373AM 8, 10, 11, 12, 13, 14, 15, 17, 19	color box	1.00	1 / 24
12208SRS	8	 3732S 5/16", 3/8", 7/16", 1/2", 9/16", 5/8", 11/16", 3/4"	color box	0.90	1 / 24



Combination Wrench

KT No. & D1



1060

- European slimline type
- 15° open end angle
- 15° ring end offset from shaft
- Chrome vanadium alloy steel

- Chrome plated
- Metric - DIN 3113 from A, ISO 7738
- Inch - ANSI / ASME B107.6

KT NO.	Size mm	L mm		
1060-55	5.5	105	17	12 / 504
1060-06	6	105	16	12 / 504
1060-07	7	115	22	12 / 504
1060-08	8	125	24	12 / 504
1060-09	9	135	32	12 / 504
1060-10	10	145	41	12 / 504
1060-11	11	155	46	12 / 504
1060-12	12	165	59	12 / 216
1060-13	13	175	70	12 / 216
1060-14	14	185	87	12 / 216
1060-15	15	195	96	12 / 192
1060-16	16	205	111	12 / 192
1060-17	17	215	131	12 / 192
1060-18	18	225	156	12 / 144
1060-19	19	235	163	12 / 144
1060-20	20	245	189	12 / 144
1060-21	21	255	206	12 / 96
1060-22	22	265	243	12 / 96
1060-23	23	275	258	12 / 96
1060-24	24	285	290	6 / 54
1060-25	25	295	312	6 / 54
1060-26	26	305	349	6 / 54
1060-27	27	315	367	6 / 54
1060-28	28	325	415	6 / 48
1060-29	29	335	463	6 / 48
1060-30	30	345	492	6 / 48
1060-32	32	365	566	6 / 48

1071

- Jumbo type
- 15° open end angle
- 15° ring end offset from shaft
- Polished, chrome plated
- Metric - DIN 3113 from A, ISO 7738
- Inch - ANSI / ASME B107.6

KT NO.	Size mm	L mm		
1071-33	33	410	802	5 / 20
1071-34	34	410	819	5 / 20
1071-35	35	425	920	5 / 20
1071-36	36	425	918	5 / 20
1071-38	38	455	1079	5 / 20
1071-41	41	495	1464	5 / 15
1071-42	42	495	1448	5 / 15
1071-44	44	495	1584	5 / 15
1071-46	46	495	1581	5 / 15
1071-48	48	563	2235	5 / 10
1071-50	50	563	2180	5 / 10
KT NO.	Size mm	L mm		
1071-55	55	610	2260	5
1071-60	60	645	3523	5
1071-65	65	670	3346	5
1071-70	70	708	5672	2
1071-75	75	708	5770	2
1071-80	80	730	7778	2
1071-85	85	730	7575	2

5060

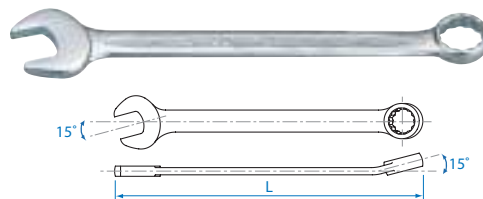

KT NO.	Size inch	L mm		
5060-08	1/4	105	17	12 / 504
5060-10	5/16	125	24	12 / 504
5060-12	3/8	145	40	12 / 504
5060-14	7/16	155	47	12 / 504
5060-16	1/2	175	70	12 / 216
5060-18	9/16	185	87	12 / 216
5060-20	5/8	205	113	12 / 192
5060-22	11/16	215	136	12 / 192
5060-24	3/4	235	175	12 / 144
5060-26	13/16	255	214	12 / 96
5060-28	7/8	265	234	12 / 96
5060-30	15/16	285	280	6 / 54
5060-32	1	295	309	6 / 54
5060-34	1-1/16	315	370	6 / 54
5060-36	1-1/8	335	462	6 / 48
new 5060-38	1-3/16	345	470	6 / 48
5060-40	1-1/4	365	560	6 / 48

5071

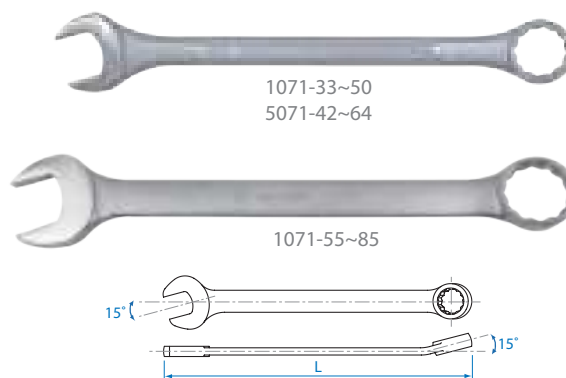

KT NO.	Size inch	L mm		
5071-42	1-5/16	410	816	5 / 20
5071-44	1-3/8	425	951	5 / 20
5071-46	1-7/16	425	920	5 / 20
5071-48	1-1/2	455	1085	5 / 20
5071-50	1-9/16	495	1532	5 / 15
5071-52	1-5/8	495	1520	5 / 15
5071-54	1-11/16	495	1598	5 / 15
5071-56	1-3/4	495	1609	5 / 15
5071-58	1-13/16	495	1554	5 / 15
5071-60	1-7/8	563	2317	5 / 10
5071-62	1-15/16	563	2245	5 / 10
5071-64	2	563	2248	5 / 10
5071-72	2-1/4"			
5071-80	2-1/2"			
5071-88	2-3/4"			
5071-96	3"			







Combination Wrench Set



► MRN / SRN : Teton pouch bag

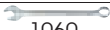

► MR / SR : Nylon pouch bag

KT NO.	PC.	Contents	Package		
1207MR	7	10, 11, 12, 13, 14, 17, 19	Nylon	0.71	1 / 30
1208MR	8	10, 11, 12, 13, 14, 17, 19, 22	Nylon	0.95	1 / 24
1210MR	10	8, 10, 12, 13, 14, 17, 19, 21, 22, 24	Nylon	1.38	1 / 16
1211MR	11	8, 9, 10, 11, 12, 13, 14, 17, 19, 22, 24	Nylon	1.33	1 / 16
1212MR	12	8, 9, 10, 11, 12, 13, 14, 15, 16, 17, 19, 22	Nylon	1.28	1 / 16
1212MR01	12	6, 8, 10, 12, 13, 14, 17, 19, 24, 27, 30, 32	Nylon	3.23	1 / 8
1214MR	14	10, 11, 12, 13, 14, 16, 17, 19, 21, 22, 24, 27, 30, 32	Nylon	3.18	1 / 8
1214MRN	14	10, 11, 12, 13, 14, 16, 17, 19, 21, 22, 24, 27, 30, 32	Teton	3.31	1 / 8
1214MR01	14	10, 11, 13, 14, 16, 17, 18, 19, 21, 22, 24, 27, 30, 32	Nylon	3.25	1 / 8
1215MR	14	 1060 8, 9, 10, 11, 12, 13, 14, 15, 16, 17, 19, 21, 22, 24	Nylon	1.86	1 / 12
1215MR01	14	8, 10, 11, 12, 13, 14, 15, 16, 17, 18, 19, 21, 22, 24	Nylon	3.22	1 / 12
1215MR02	15	6, 7, 8, 10, 11, 12, 13, 14, 17, 19, 22, 24, 27, 30, 32	Nylon	2.92	1 / 8
1211MRN	11	8, 9, 10, 11, 12, 13, 14, 17, 19, 22, 24	Teton	1.33	1 / 16
1214MRN05	14	6, 7, 8, 9, 10, 11, 12, 13, 14, 15, 16, 17, 18, 19	Teton	1.24	1 / 12
1215MRN01	14	8, 10, 11, 12, 13, 14, 15, 16, 17, 18, 19, 21, 22, 24	Teton	1.92	1 / 12
1215MRN02	15	6, 7, 8, 10, 11, 12, 13, 14, 17, 19, 22, 24, 27, 30, 32	Teton	2.92	1 / 8
1218MR01	18	6, 7, 8, 9, 10, 11, 12, 13, 14, 15, 16, 17, 18, 19, 20, 21, 22, 24	Nylon	2.5	1 / 9
1218MRN	18		Teton	1.34	1 / 9
1226MR	26	6, 7, 8, 9, 10, 11, 12, 13, 14, 15, 16, 17, 18, 19, 20, 21, 22, 23,	Nylon	5.67	1 / 4
1226MRN	26	24, 25, 26, 27, 28, 29, 30, 32	Teton	5.67	1 / 4
1207SR	7	3/8, 7/16, 1/2, 9/16, 5/8, 11/16, 3/4	Nylon	0.61	1 / 30
1211SR	11	1/4, 5/16, 3/8, 7/16, 1/2, 9/16, 11/16, 3/4, 13/16, 7/8, 15/16	Nylon	1.48	1 / 16
1211SR01	11	1/4, 5/16, 3/8, 7/16, 1/2, 9/16, 5/8, 11/16, 3/4, 7/8, 1	Nylon	1.46	1 / 16
1211SR02	11	3/8, 7/16, 1/2, 9/16, 5/8, 11/16, 3/4, 13/16, 7/8, 15/16, 1	Nylon	1.63	1 / 12
1214SR	14	 5060 5/16, 3/8, 7/16, 1/2, 9/16, 5/8, 11/16, 3/4, 13/16, 7/8, 15/16, 1, 1-1/8, 1-1/4	Nylon	3.02	1 / 8
1216SR	16	1/4, 5/16, 3/8, 7/16, 1/2, 9/16, 5/8, 11/16, 3/4, 13/16, 7/8, 15/16, 1, 1-1/16, 1-1/8, 1-1/4	Nylon	3.44	1 / 8
1216SRN	16	1/4, 5/16, 3/8, 7/16, 1/2, 9/16, 5/8, 11/16, 3/4, 13/16, 7/8, 15/16, 1, 1-1/16, 1-1/8, 1-1/4	Teton	3.63	1 / 6
1213SRN	13	1/4, 5/16, 3/8, 7/16, 1/2, 9/16, 5/8, 11/16, 3/4, 13/16, 7/8, 15/16, 1	Teton	1.96	1 / 10
1214SRN01	14	3/8, 7/16, 1/2, 9/16, 5/8, 11/16, 3/4, 13/16, 7/8, 15/16, 1, 1-1/16, 1-1/8, 1-1/4	Teton	3.54	1 / 8
1296MRN	6	 1071 34, 36, 38, 41, 46, 50	Teton	8.87	1 / 2
1224CRN	24	 1060 7, 8, 10, 11, 12, 13, 14, 15, 16, 17, 19, 22	Teton	2.93	1 / 6
		 5060 1/4, 5/16, 3/8, 7/16, 1/2, 9/16, 5/8, 11/16, 3/4, 13/16, 7/8, 15/16			



Offset Combination Wrench & Set

1063

- Chrome vanadium alloy steel
- Offset ring ideal for deep-seated nuts or bolts
- 15° open end angle
- Chrome plated
- Metric - DIN 3113 from B, ISO 7738, ISO 3318

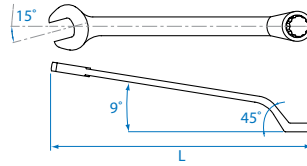

KT NO.	Size mm	L mm		
1063-06	6	110	17	20 / 360
1063-08	8	130	32	20 / 320
1063-11	11	160	50	20 / 320
1063-14	14	190	93	15 / 240
1063-15	15	200	105	15 / 180
1063-16	16	210	118	15 / 180

5063

KT NO.	Size mm	L mm		
1063-18	18	230	165	12 / 96
1063-21	21	260	226	10 / 80
1063-22	22	270	252	10 / 80
1063-30	30	350	535	6 / 48
1063-32	32	370	596	6 / 48

KT NO.	Size inch	L mm		
5063-14	7/16	160	59	20 / 320
5063-16	1/2	180	78	20 / 240
5063-18	9/16	190	103	15 / 240

1067

- Chrome vanadium alloy steel
- Offset ring ideal for deep-seated nuts or bolts
- 15° open end angle
- Chrome plated
- DIN 3113 from B, ISO 7738, ISO 3318

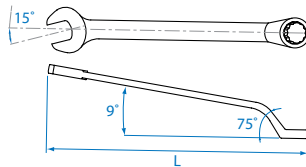

KT NO.	Size mm	L mm		
1067-06	6	105	18	10 / 640
1067-07	7	115	23	10 / 640
1067-08	8	125	32	10 / 640
1067-09	9	135	37	10 / 480
1067-10	10	145	45	6 / 288
1067-11	11	155	56	12 / 240
1067-12	12	165	61	10 / 200
1067-13	13	175	73	8 / 160
1067-14	14	185	96	10 / 160
1067-15	15	195	105	10 / 160
1067-16	16	205	122	10 / 160
1067-17	17	215	138	8 / 128
1067-18	18	225	161	12 / 144

KT NO.	Size mm	L mm		
1067-19	19	235	192	10 / 120
1067-20	20	235	256	10 / 80
1067-21	21	265	248	10 / 80
1067-22	22	265	252	10 / 80
1067-23	23	290	316	8 / 64
1067-24	24	290	307	8 / 64
1067-25	25	300	327	10 / 60
1067-26	26	320	423	10 / 40
1067-27	27	320	402	10 / 40
1067-28	28	330	494	10 / 40
1067-29	29	350	402	6 / 48
1067-30	30	350	522	6 / 48
1067-32	32	370	621	4 / 32



► MRN / SRN : Teton pouch bag



► MR / SR : Nylon pouch bag

KT NO.	PC.	Contents	Package		
1271MR	11		Nylon		
1271MRN	11	6, 8, 9, 10, 11, 12, 13, 14, 17, 19, 22	Teton	1.23	1 / 15
1272MR	12	6, 7, 8, 9, 10, 11, 12, 13, 14, 17, 19, 22	Nylon	1.21	1 / 15
1275MR	15	6, 7, 8, 10, 11, 12, 13, 14, 17, 19, 22, 24, 27, 30, 32	Nylon	3.3	1 / 8
1275MRN	15		Teton		
1266MR	26	6, 7, 8, 9, 10, 11, 12, 13, 14, 15, 16, 17, 18, 19, 20, 21, 22, 23, 24, 25, 26, 27, 28, 29, 30, 32	Nylon	6.85	1 / 2

Stubby Combination Wrench & Set

KT No. & D1



10D0

- Short pattern design enables greater access in confined spaces
- Chrome vanadium alloy steel
- Chrome plated
- DIN 3113 from A

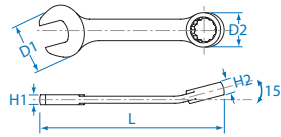

KT NO.	Size mm	D1	D2	H1	H2	L mm		
10D0-08	8	18.1	13.8	4.6	6.0	85	20	20 / 360
10D0-09	9	19.3	14.5	4.8	6.4	90	23	20 / 360
10D0-10	10	20.5	15.1	4.8	6.4	95	28	20 / 360
10D0-11	11	22.7	16.7	5.9	7.9	100	45	20 / 360
10D0-12	12	24.7	18.0	6.2	8.3	105	46	20 / 360
10D0-13	13	27.2	19.1	6.5	8.7	110	56	20 / 360
10D0-14	14	28.8	21.4	7.0	9.2	115	69	15 / 270
10D0-15	15	31.0	22.4	7.4	9.7	120	76	15 / 270
10D0-16	16	33.0	23.8	7.8	10.3	125	93	15 / 270
10D0-17	17	35.0	26.2	8.1	10.7	130	106	15 / 180
10D0-18	18	37.0	27.3	8.6	11.3	135	126	15 / 180
10D0-19	19	39.0	28.6	9.0	11.8	140	143	12 / 144

1282MR

Contents

10D0	8, 9, 10, 11, 12, 13, 14, 15, 16, 17, 18, 19	1.03	1 / 24
------	--	------	--------



12 PC.

► Nylon pouch bag

Single Open End Wrench



CAUTION Please wear proper safety gear while working.

10F0

- Features : The open end is thicker for very high tightening torques. Examples : public work, rail worksite, naval construction, agriculture, oil platforms, metallic construction
- Hanging hole at end of handle: wrenches stored on panel or hung to avoid loss or fall
- Chrome vanadium alloy steel
- Finished with phosphate sunk
- DIN 894

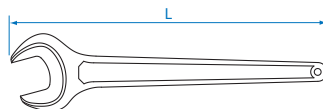

KT NO.	Size mm	L mm		
10F0-17P	17	178	107	10 / 120
10F0-19P	19	178	107	10 / 120
10F0-21P	21	203	161	10 / 100
10F0-22P	22	203	161	10 / 100
10F0-23P	23	220	203	8 / 80
10F0-24P	24	220	203	8 / 80
10F0-26P	26	240	290	6 / 60
10F0-27P	27	240	290	6 / 60
10F0-29P	29	267	341	6 / 48
10F0-30P	30	267	335	6 / 48
10F0-32P	32	285	410	5 / 30

KT NO.	Size mm	L mm		
10F0-36P	36	317	556	5 / 30
10F0-38P	38	320	740	5 / 30
10F0-41P	41	340	875	4 / 24
10F0-46P	46	395	1060	3 / 12
10F0-50P	50	425	1402	1 / 12
10F0-55P	55	425	1403	1 / 12
10F0-60P	60	470	2544	1 / 6
10F0-65P	65	470	2441	1 / 6
10F0-70P	70	500	3457	1 / 6
10F0-75P	75	500	3333	1 / 6

Open End Wrench & Set

1900

- European slimline type
- 15° open end angle
- Chrome vanadium alloy steel
- Chrome plated
- Metric - DIN 3110
- Inch - ANSI / ASME B107.6

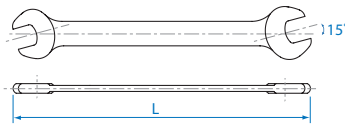

5900



KT NO.	Size mm	L mm	g	Box
19005507	5.5 x 7	123	20	12 / 576
19000607	6 x 7	123	23	12 / 576
19000708	7 x 8	140	33	12 / 576
19000809	8 x 9	140	32	12 / 576
19000810	8 x 10	140	33	12 / 576
19000911	9 x 11	156	56	12 / 288
19001011	10 x 11	156	46	12 / 288
19001012	10 x 12	156	45	12 / 288
19001113	11 x 13	172	65	12 / 288
19001213	12 x 13	172	80	12 / 288
19001214	12 x 14	172	64	12 / 288
19001314	13 x 14	172	81	12 / 288
19001317	13 x 17	195	104	12 / 192
19001415	14 x 15	188.5	89	12 / 192
19001417	14 x 17	195	106	12 / 192
19001617	16 x 17	204	122	12 / 192
19001618	16 x 18	221	158	12 / 144
19001719	17 x 19	221	158	12 / 144
19001819	18 x 19	221	160	12 / 144
19001921	19 x 21	237	207	12 / 144
19001922	19 x 22	237	203	12 / 144
19002022	20 x 22	237	209	12 / 144
19002123	21 x 23	247	241	6 / 72
19002224	22 x 24	247	235	6 / 72
19002326	23 x 26	263	305	6 / 72
19002426	24 x 26	263	295	6 / 72
19002427	24 x 27	263	301	6 / 72

KT NO.	Size mm	L mm	g	Box
19002430	24 x 30	263	306	6 / 72
19002528	25 x 28	279	348	6 / 48
19002632	26 x 32	285	438	6 / 48
19002729	27 x 29	279	348	6 / 48
19002730	27 x 30	285	431	6 / 48
19002732	27 x 32	285	434	6 / 48
19003032	30 x 32	298	439	6 / 48
19003036	30 x 36	351	715	6 / 36
19003236	32 x 36	351	723	5 / 30
19003436	34 x 36	351	717	5 / 30
19003641	36 x 41	380	998	4 / 24
19004146	41 x 46	430	1337	4 / 16

KT NO.	Size inch	L mm	g	Box
59000810	1/4 x 5/16	123	23	12 / 576
59001012	5/16 x 3/8	140	32	12 / 576
59001214	3/8 x 7/16	156	45	12 / 288
59001416	7/16 x 1/2	172	69	12 / 288
59001618	1/2 x 9/16	172	70	12 / 288
59001820	9/16 x 5/8	188.5	88	12 / 192
59002022	5/8 x 11/16	204	120	12 / 192
59002224	11/16 x 3/4	221	163	12 / 144
59002628	13/16 x 7/8	237	202	12 / 144
59003032	15/16 x 1	247	311	6 / 72
59003034	15/16 x 1-1/16	263	304	6 / 72
59003236	1 x 1-1/8	279	341	6 / 48
59003640	1-1/8 x 1-1/4	298	431	6 / 48



► MRN / SRN : Teton pouch bag



► MR / SR : Nylon pouch bag

KT NO.	PC.	Contents	Package	Kg	Box
1106MR	6	8 x 9, 10 x 12, 12 x 14, 14 x 17, 17 x 19, 21 x 23	Nylon	0.83	1 / 24
1106MR01	6	8 x 9, 10 x 11, 12 x 13, 14 x 15, 16 x 17, 18 x 19	Nylon	0.81	1 / 24
1108MR	8	6 x 7, 8 x 9, 10 x 11, 12 x 13, 14 x 15, 16 x 17, 18 x 19, 20 x 22	Nylon	0.91	1 / 24
1110MR	10	6 x 7, 8 x 9, 10 x 11, 12 x 13, 14 x 15, 16 x 17, 18 x 19, 20 x 22, 24 x 27, 25 x 28	Nylon	1.67	1 / 16
1112MR	12	6 x 7, 8 x 9, 10 x 11, 12 x 13, 14 x 15, 16 x 17, 18 x 19, 20 x 22, 21 x 23, 24 x 27, 25 x 28, 30 x 32	Nylon	2.37	1 / 10
1112MRN	12	6 x 7, 8 x 9, 10 x 11, 12 x 13, 14 x 15, 16 x 17, 18 x 19, 20 x 22, 21 x 23, 24 x 27, 25 x 28, 30 x 32	Teton	2.45	1 / 10
1108SR	8	1/4 x 5/16, 5/16 x 3/8, 3/8 x 7/16, 7/16 x 1/2, 9/16 x 5/8, 5/8 x 11/16, 11/16 x 3/4, 13/16 x 7/8	Nylon	0.91	1 / 24
1112SR	12	1/4 x 5/16, 5/16 x 3/8, 3/8 x 7/16, 7/16 x 1/2, 9/16 x 5/8, 5/8 x 11/16, 11/16 x 3/4, 13/16 x 7/8, 15/16 x 1, 15/16 x 1-1/16, 1 x 1-1/8, 1-1/8 x 1-1/4	Nylon	2.5	1 / 10

45° Offset Ring Wrench & Set

KT No. & D1



1960

- 45° offset ring
- Thin wall rings
- Chrome vanadium alloy steel
- Chrome plated
- Metric - DIN 838
- Inch - ANSI / ASME B107.6

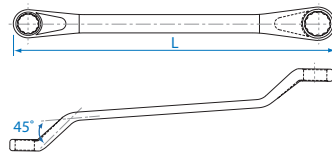

5960



KT NO.	Size mm	L mm		
19600607	6 x 7	165	47	12 / 360
19600809	8 x 9	175	55	12 / 360
19600810	8 x 10	185	70	12 / 360
19601011	10 x 11	195	90	12 / 360
19601012	10 x 12	185	90	12 / 360
19601113	11 x 13	205	105	12 / 240
19601213	12 x 13	205	103	12 / 240
19601214	12 x 14	220	126	12 / 240
19601415	14 x 15	235	138	12 / 144
19601417	14 x 17	235	156	12 / 144
19601617	16 x 17	240	180	12 / 144
19601719	17 x 19	250	204	6 / 72
19601819	18 x 19	250	210	6 / 72

KT NO.	Size mm / inch	L mm		
19601921	19 x 21	270	253	6 / 72
19602022	20 x 22	270	242	6 / 72
19602123	21 x 23	320	460	6 / 48
19602224	22 x 24	320	372	6 / 48
19602326	23 x 26	360	451	6 / 48
19602426	24 x 26	360	460	6 / 48
19602427	24 x 27	360	437	6 / 48
19602732	27 x 32	385	658	6 / 36
19603032	30 x 32	392	697	6 / 36
59601214	3/8 x 7/16	185	79	12 / 360
59601618	1/2 x 9/16	220	122	12 / 240
59602022	5/8 x 11/16	240	167	12 / 144
59602428	3/4 x 7/8	270	243	6 / 72
59603032	15/16 x 1	360	420	6 / 48



► Nylon pouch bag

KT NO.	PC.	Contents		
1606MR	6	10 x 12, 12 x 14, 14 x 17, 17 x 19, 19 x 21, 23 x 26	1.6	1 / 16
1611MR	11	1960 6 x 7, 8 x 9, 10 x 11, 12 x 13, 14 x 15, 16 x 17, 18 x 19, 20 x 22, 21 x 23, 24 x 26, 30 x 32	3.0	1 / 16



1961

- Mini type
- 45° offset ring
- Thin wall rings
- Chrome vanadium steel
- Chrome plated
- Metric - DIN 838

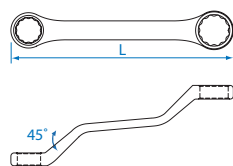

KT NO.	Size mm	L mm		
19611415	14 x 15	140	87	12 / 240

KT NO.	Size mm	L mm		
19611617	16 x 17	150	96	10 / 200
19611819	18 x 19	157	115	6 / 120





WRENCHES

75° Offset Ring Wrench & Set



1970

- European slimline type
- 75° deep ring offset
- Thin wall rings
- Chrome vanadium alloy steel
- Chrome plated
- Metric - DIN 838
- Inch - ANSI / ASME B107.6





KT NO.	Size mm	L mm		
19700607	6 x 7	168	46	12 / 360
19700809	8 x 9	183	69	12 / 360
19700810	8 x 10	183	68	12 / 360
19701011	10 x 11	198	95	12 / 240
19701012	10 x 12	198	87	12 / 240
19701113	11 x 13	217	129	12 / 144
19701213	12 x 13	217	125	12 / 144
19701214	12 x 14	217	125	12 / 144
19701314	13 x 14	217	124	12 / 144
19701415	14 x 15	239	175	12 / 144
19701417	14 x 17	260	191	6 / 96
19701617	16 x 17	260	225	6 / 96
19701719	17 x 19	292	297	6 / 72
19701819	18 x 19	292	289	6 / 72
19701921	19 x 21	318	340	6 / 60
19701922	19 x 22	318	318	6 / 60
19702022	20 x 22	318	319	6 / 60
19702123	21 x 23	330	379	6 / 60
19702224	22 x 24	330	370	6 / 60
19702326	23 x 26	345	451	6 / 48
19702426	24 x 26	345	477	6 / 48
19702427	24 x 27	345	469	6 / 48
19702528	25 x 28	350	503	6 / 48
19703032	30 x 32	362	638	6 / 36

5970



KT NO.	Size inch	L mm		
59700810	1/4 x 5/16	168	49	12 / 360
59701012	5/16 x 3/8	183	63	12 / 360
59701214	3/8 x 7/16	198	93	12 / 240
59701416	7/16 x 1/2	217	123	12 / 144
59701618	1/2 x 9/16	217	126	12 / 144
59701820	9/16 x 5/8	260	158	12 / 96
59702022	5/8 x 11/16	260	223	6 / 96
59702224	11/16 x 3/4	292	277	6 / 96
59702428	3/4 x 7/8	318	319	6 / 60
59702628	13/16 x 7/8	330	377	6 / 60
59703032	15/16 x 1	345	460	6 / 48
59703436	1-1/16 x 1-1/8	350	515	6 / 48
59703640	1-1/8 x 1-1/4	362	703	6 / 48
59703842	1-3/16 x 1-5/16	375	750	5 / 30



KT NO.	PC.	Contents	Package		
1706MR	6	6 x 7, 8 x 9, 10 x 11, 12 x 13, 14 x 15, 16 x 17	Nylon	0.88	1 / 24
1708MR	8	6 x 7, 8 x 9, 10 x 11, 12 x 13, 14 x 15, 16 x 17, 18 x 19, 21 x 23	Nylon	1.64	1 / 12
1708MR01	8	6 x 7, 8 x 9, 10 x 11, 12 x 13, 14 x 15, 16 x 17, 18 x 19, 20 x 22	Nylon	1.52	1 / 12
1710MR	10	 1970 6 x 7, 8 x 9, 10 x 11, 12 x 13, 14 x 15, 16 x 17, 18 x 19, 21 x 23, 24 x 27, 30 x 32	Nylon	2.83	1 / 8
1712MR	12	6 x 7, 8 x 9, 10 x 11, 12 x 13, 14 x 15, 16 x 17, 18 x 19, 20 x 22, 21 x 23, 24 x 26, 25 x 28, 30 x 32	Nylon	3.78	1 / 6
1712MRN	12	6 x 7, 8 x 9, 10 x 11, 12 x 13, 14 x 15, 16 x 17, 18 x 19, 20 x 22, 21 x 23, 24 x 27, 25 x 28, 30 x 32	Tetoron	3.78	1 / 6
1712MRN01	12	6 x 7, 8 x 9, 10 x 11, 12 x 13, 14 x 15, 16 x 17, 18 x 19, 20 x 22, 21 x 23, 24 x 27, 25 x 28, 30 x 32	Tetoron	3.78	1 / 6
1707SR	7	 5970 1/4 x 5/16, 3/8 x 7/16, 1/2 x 9/16, 5/8 x 11/16, 3/4 x 7/8, 15/16 x 1, 1-1/16 x 1-1/8	Nylon	2.0	1 / 12

Straight Ring Wrench & Set

KT No. & D1



19C0

- Thin wall rings
- Chrome vanadium alloy steel
- Chrome plated
- DIN 837

KT NO.	Size mm	L mm		
19C00607	6 x 7	121	20	20 / 480
19C00809	8 x 9	137	33	20 / 480
19C01011	10 x 11	154	52	20 / 320
19C01213	12 x 13	164	69	20 / 240
19C01415	14 x 15	182	85	20 / 240
19C01617	16 x 17	211	127	12 / 144
19C01819	18 x 19	226	160	12 / 144
19C02022	20 x 22	240	208	10 / 120
19C02123	21 x 23	255	238	10 / 120
19C02426	24 x 26	270	316	6 / 72
19C02528	25 x 28	285	368	6 / 72
19C03032	30 x 32	335	540	5 / 40

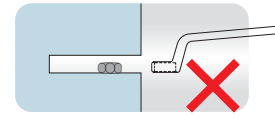
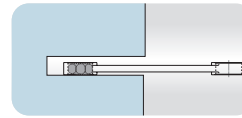
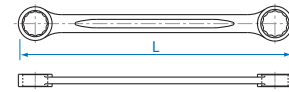

► Nylon pouch bag

KT NO.	PC.	Contents		
1C08MR	8	6 x 7, 8 x 9, 10 x 11, 12 x 13, 14 x 15, 16 x 17, 18 x 19, 20 x 22	0.79	1 / 24
1C12MR	12	6 x 7, 8 x 9, 10 x 11, 12 x 13, 14 x 15, 16 x 17, 18 x 19, 20 x 22, 21 x 23, 24 x 26, 25 x 28, 30 x 32	2.23	1 / 12

0° Offset Ring Wrench

19B0

- Ideal for crowded or confined spaces
- Ultra-compact ring head
- Chrome molybdenum alloy steel
- Chrome plated
- DIN 3113

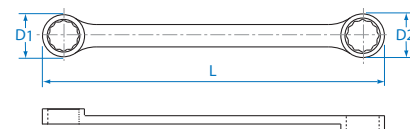

KT NO.	Size mm	D1 mm	D2 mm	L mm		
19B00810	8 x 10	12.5	15	235	72	12 / 240
19B01011	10 x 11	14.3	17	291	95	12 / 192
19B01012	10 x 12	14.3	17	291	95	12 / 192
19B01113	11 x 13	17.8	20.3	328	157	12 / 120
19B01214	12 x 14	17.8	20.3	328	157	12 / 120
19B01315	13 x 15	20.2	23.3	368	217	12 / 96
19B01417	14 x 17	20.2	23.3	368	217	12 / 96
19B01618	16 x 18	23.7	26.6	407	284	12 / 72
19B01719	17 x 19	23.7	26.6	407	284	12 / 72
19B01921	19 x 21	27.5	29.7	415	376	8 / 64
19B02224	22 x 24	31.3	34.0	430	482	6 / 48





WRENCHES

0° Offset Ring Wrench Set

1F06MRN

Contents

			
19B0	10 x 11, 12 x 14, 13 x 15, 16 x 18, 17 x 19, 22 x 24	1.81	1 / 8



6
PC.



► Teton pouch bag

Half Moon Ring Wrench & Set

1950

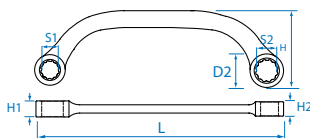
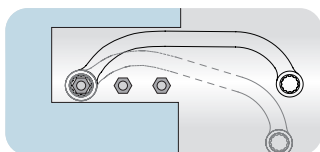

- Short pattern design enables greater access in confined spaces
- Chrome vanadium alloy steel
- Chrome plated
- DIN 3113



KT NO.	Size mm	D1 mm	D2 mm	L mm	H1 mm	H2 mm	H mm		
19500810	8 x 10	15.6	14.3	137	6.5	6.2	42	40	12 / 288
19501012	10 x 12	15.6	18.2	141	6.6	6.5	50	61	12 / 288
19501113	11 x 13	18.2	21.0	166	8.2	8.0	63	101	8 / 128
19501214	12 x 14	18.2	21.0	166	8.2	8.0	63	95	8 / 128
19501315	13 x 15	22.0	25.0	190	9.2	8.2	75	133	6 / 72
19501417	14 x 17	22.0	25.0	190	9.2	8.2	75	130	6 / 72
19501618	16 x 18	25.5	28.0	220	9.6	8.8	79	164	6 / 72
19501719	17 x 19	25.5	28.0	220	9.6	8.8	79	163	6 / 72
19501922	19 x 22	28.6	32.5	256	11.1	10.1	91	257	6 / 48



Contents

KT NO.	PC.			
9-1905MR	5	 1950 10 x 12, 11 x 13, 14 x 17, 16 x 18, 19 x 22	0.82	1 / 10



Crowfoot Wrench & Set

1031

- 12 points
- For union nuts and tube connections
- With square mount

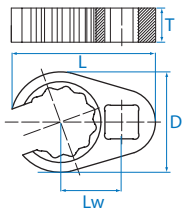

KT NO.	Size mm	Drive square	D mm	T mm	L mm	Lw mm	g	kg	pc
1031-10R	10	3/8"	27.0	9.2	36.5	17.1	40	12	192
1031-11R	11	3/8"	27.0	9.2	36.5	17.0	40	12	192
1031-12R	12	3/8"	27.5	9.2	36.5	16.8	40	12	192
1031-13R	13	3/8"	27.2	9.3	36.5	16.7	40	12	192
1031-14R	14	3/8"	29.8	9.6	42.0	20.0	42	12	192
1031-15R	15	3/8"	31.4	9.2	42.0	19.2	44	12	192
1031-16R	16	3/8"	30.2	10.1	42.0	19.5	48	12	192
1031-17R	17	3/8"	34.0	11.4	45.6	23.5	68	12	192
1031-18R	18	3/8"	33.6	10.0	45.6	22.5	63	12	192
1031-19R	19	3/8"	33.7	10.8	45.8	23.0	63	12	192
1031-22R	22	1/2"	38.5	13.0	55.0	23.0	82	15	180
1031-24R	24	1/2"	38.5	12.5	55.0	24.5	74	15	180
1031-26R	26	1/2"	42.5	13.5	60.0	24.0	105	15	180
1031-27R	27	1/2"	42.5	13.5	61.0	25.0	98	15	180
1031-30R	30	1/2"	49.0	14.0	68.5	30.0	136	12	144
1031-32R	32	1/2"	50.0	14.0	70.0	30.0	136	12	144

- Use to reach limit place with extension bar
- Use with torque wrench and 90° extension bar, will not effectively change the torque value

KT NO.	Size mm	Drive square	D mm	T mm	L mm	Lw mm	g	kg	pc
1031-34R	34	3/4"	55.6	22.5	84.5	38.0	345	12	60
1031-35R	35	3/4"	55.6	22.5	84.5	39.0	334	12	60
1031-36R	36	3/4"	55.6	22.5	84.5	39.0	315	12	60
1031-38R	38	3/4"	61.7	23.0	90.5	43.0	346	12	60
1031-41R	41	3/4"	61.7	23.0	90.5	43.0	357	12	60
1031-46R	46	3/4"	70.0	25.0	101	47.0	517	12	24
1031-48R	48	3/4"	75.5	28.5	104	47.0	482	12	24
1031-50R	50	3/4"	75.5	28.5	104	48.0	587	12	24



KT NO.	PC.	Contents	kg	pc
1E10MR	10	10, 11, 12, 13, 14, 15, 16, 17, 18, 19	0.59	1 / 30
1E11MR	11	1031 10, 11, 12, 13, 14, 15, 16, 17, 18, 19, 22	0.68	1 / 30



Star Box End Wrench & Set

1920

- Chrome vanadium alloy steel
- Chrome plated
- ANSI / ASME B107.6

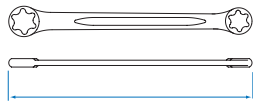

KT NO.	Size	L mm		
19200608	E6 x E8	114.0	21	12 / 504
19200711	E7 x E11	126.5	31	12 / 504
19201012	E10 x E12	142.5	43	12 / 384
19201418	E14 x E18	183.0	90	12 / 240
19201622	E16 x E22	205.0	114	12 / 192
19202024	E20 x E24	225.0	159	12 / 144

1406PR

Metal case size (mm):
280 x 130 x 41 (0.053 cuft)



6 PC.

Contents

0.46 1 / 15

1920	E6 x E8, E7 x E11, E10 x E12, E14 x E18, E16 x E22, E20 x E24
------	---

Flare Nut Wrench

1930

- 6 points
- 12° ring offset
- Chrome vanadium alloy steel
- Chrome plated
- Metric - DIN 3118
- Inch - ANSI / ASME B107.6

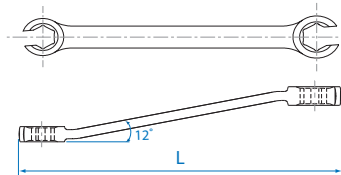

KT NO.	Size mm	L mm		
19300810	8 x 10	130	56	12 / 216
19300911	9 x 11	150	74	12 / 216
19301011	10 x 11	150	76	12 / 192
19301012	10 x 12	150	73	12 / 192
19301113	11 x 13	170	96	12 / 144
19301213	12 x 13	170	102	12 / 144
19301214	12 x 14	170	100	12 / 144
19301315	13 x 15	178	122	12 / 144
19301417	14 x 17	190	138	12 / 144
19301719	17 x 19	210	170	8 / 128
19301922	19 x 22	230	245	9 / 108

5930



KT NO.	Size inch	L mm		
59301012	5/16 x 3/8	130	60	12 / 216
59301214	3/8 x 7/16	150	76	12 / 192
new 59301416	7/16 x 1/2	170	106	12 / 144
59301618	1/2 x 9/16	170	125	12 / 144
59301820	9/16 x 5/8	190	169	12 / 144
59302224	11/16 x 3/4	210	184	6 / 96
59302428	3/4 x 7/8	230	249	6 / 72



► MRN / SRN : Teton pouch bag



► MR / SR : Nylon pouch bag



► 1305SR : Nylon pouch bag

KT NO.	PC.	Contents	Package		
1306MR	6	1930	Nylon	0.90	1 / 30
1306MRN	6	1930	Teton	0.90	1 / 30
new 1305SR	5	5930	Nylon	0.82	1 / 24

Flare Nut Wrench & Set

KT No. & D1



1931

- 12 points
- 12° ring offset
- Chrome vanadium alloy steel
- Chrome plated
- DIN 3118

KT NO.	Size mm	L mm		
19312224	22 x 24	250	309	6 / 72
19312427	24 x 27	270	406	6 / 48
19313032	30 x 32	290	546	5 / 40

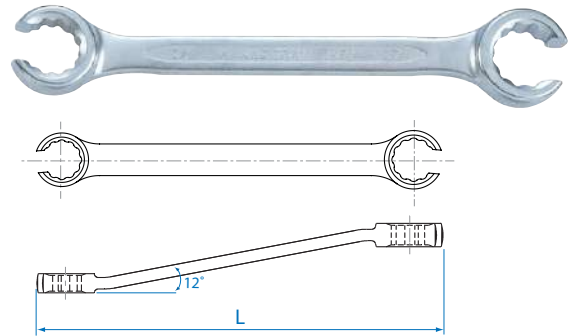

Flexible Head Wrench & Set

1020

- Combination flexible head wrench with 12 points thin wall socket
- 180° swivel head for better accessibility
- Chrome vanadium alloy steel
- Chrome plated

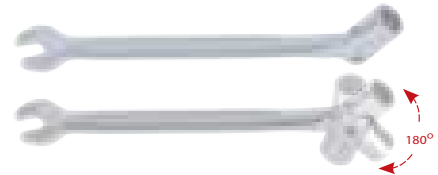

KT NO.	Size mm	L mm		
1020-08	8	170	64	10 / 180
1020-09	9	170	68	10 / 180
1020-10	10	180	81	10 / 160
1020-11	11	188	106	10 / 160
1020-12	12	190	107	10 / 120
1020-13	13	206	135	10 / 120

KT NO.	Size mm	L mm		
1020-14	14	225	167	10 / 120
1020-15	15	225	193	6 / 72
1020-16	16	234	224	6 / 72
1020-17	17	234	237	4 / 48
1020-18	18	252	295	4 / 48
1020-19	19	250	290	4 / 48

1910

- Double end flexible head wrench with 12 points thin wall socket
- 180° swivel head for better accessibility
- Chrome vanadium alloy steel
- Chrome plated

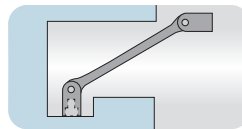
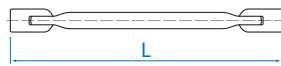

KT NO.	Size mm	L mm		
19100607	6 x 7	182	76	12 / 216
19100809	8 x 9	182	81	12 / 216
19100810	8 x 10	185	88	10 / 160
19101011	10 x 11	200	109	10 / 160
19101012	10 x 12	205	122	10 / 120
19101213	12 x 13	220	158	10 / 120
19101214	12 x 14	225	178	10 / 80
19101415	14 x 15	240	232	10 / 120
19101417	14 x 17	244	256	10 / 120
19101617	16 x 17	259	317	10 / 80

KT NO.	Size mm	L mm		
19101719	17 x 19	260	341	10 / 80
19101819	18 x 19	275	393	6 / 54
19101921	19 x 21	300	526	6 / 36
19102022	20 x 22	305	579	6 / 36
19102123	21 x 23	305	631	6 / 36
19102427	24 x 27	335	797	6 / 24

KT NO.	PC.	Contents		
1B06MR	6	1020 10, 12, 13, 14, 17, 19	1.06	1 / 24
1A06MR	6	1910 8 x 9, 10 x 11, 12 x 13, 14 x 15, 16 x 17, 18 x 19	1.49	1 / 16



► Nylon pouch bag



WRENCHES

Slogging Wrench



10A0

- Open end slogging
- Finished with phosphate sunk
- DIN 133

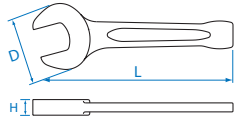

KT NO.	Size mm	L mm	D mm	H mm		
10A0-24	24	178	52	15	286	6 / 72
10A0-27	27	180	55	16	339	6 / 72
10A0-30	30	190	60	16	416	6 / 60
10A0-32	32	190	61	17	401	6 / 60
10A0-36	36	215	72	17	573	6 / 24
10A0-41	41	233	83	19	855	5 / 20
10A0-46	46	255	94	20	1102	4 / 16
10A0-50	50	275	105	22	1502	2 / 16
10A0-55	55	298	115	24	2161	2 / 12
10A0-60	60	320	127	24	2374	1 / 10
10A0-65	65	340	138	27	3204	1 / 8
10A0-70	70	370	156	32	3785	1 / 5
10A0-75	75	372	153	31	3715	1 / 5
10A0-80	80	395	175	33	6820	1 / 4
10A0-85	85	395	175	33	6300	1 / 4
10A0-90	90	440	197	38	9270	1 / 2
10A0-95	95	440	197	38	8700	1 / 2
10A0-A0	100	480	230	45	10500	1 / 2
10A0-A5	105	480	230	45	10300	1 / 2
10A0-B0	110	505	238	47	14420	1 / 1
10A0-B5	115	505	250	53	14420	1 / 1
10A0-C0	120	530	258	53	15450	1 / 1
10A0-C5	125	530	258	56	15015	1 / 1

10B0

- Ring slogging
- Finished with phosphate sunk
- DIN 7444

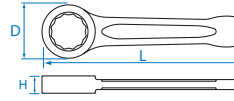

KT NO.	Size mm	L mm	D mm	H mm		
10B0-24	24	162	42	16	238	6 / 72
10B0-26	26	180	46	17	341	6 / 72
10B0-27	27	180	46	17	330	6 / 72
10B0-30	30	190	52	18	431	6 / 72
10B0-32	32	190	52	18	404	6 / 60
10B0-36	36	205	58	19	534	6 / 36
10B0-41	41	230	66	21	728	6 / 24
10B0-46	46	240	74	23	877	4 / 16
10B0-50	50	250	82	23	1085	4 / 16
10B0-55	55	265	88	24	1429	2 / 16
10B0-60	60	275	95	26	1644	2 / 12
10B0-65	65	295	104	28	1875	2 / 12
10B0-70	70	325	112	33	2965	1 / 8
10B0-75	75	325	115	33	2735	1 / 8
10B0-80	80	345	128	36	3675	1 / 6
10B0-85	85	345	130	36	3710	1 / 6
10B0-90	90	380	152	40	5850	1 / 4
10B0-95	95	380	152	40	5350	1 / 4
10B0-A0	100	410	161	43	6445	1 / 4
10B0-A5	105	415	172	45	6500	1 / 3
10B0-B0	110	440	172	47	8000	1 / 3
10B0-B5	115	440	172	47	7500	1 / 3
10B0-C0	120	470	194	53	9000	1 / 2

Heavy Duty Offset Ring Wrench

10C0

- To be used with extension tubes item "11"
- Chrome vanadium alloy steel
- Chrome plated



KT NO.	Size mm	L mm	Applied tube		
10C0-24	24	178	111946	463	6 / 48
10C0-27	27	188	111946	523	6 / 48
10C0-30	30	198	111946	579	4 / 36
10C0-32	32	233	112261	841	4 / 24
10C0-36	36	241	112261	946	4 / 24
10C0-41	41	260	112261	1099	2 / 16
10C0-46	46	277	112576	1365	2 / 16
10C0-50	50	287	112576	1642	2 / 16
10C0-55	55	298	112576	1766	1 / 12
10C0-60	60	345	113086	2800	1 / 9
10C0-65	65	356	113086	3183	1 / 4

11

- Tube for item 10C0
- Chrome plated



KT NO.	mm	L mm	Applied wrench size		
111946	19	460	24mm, 27mm, 30mm	1050	20
112261	22	610	32mm, 36mm, 41mm	1450	16
112576	24	760	46mm, 50mm, 55mm	2400	6
113086	30	860	60mm, 65mm	2610	4

End Tubular Wrench

19A0

- Chrome vanadium alloy steel
- Chrome plated

KT NO.	Ø	D1	D2	L2	L3	L	g	kg	mm
19A00607	6 x 7	10	11	5	6	105	41	30	180
19A00809	8 x 9	13	14	6	7	110	55	30	180
19A01011	10 x 11	15	16	7.5	8	120	84	24	144
19A01213	12 x 13	18	19	9	9.5	140	141	18	144
19A01415	14 x 15	20	22	10	11	145	137	12	96
19A01617	16 x 17	23	24	11	12	155	186	10	90
19A01819	18 x 19	25	26	13	15	165	240	8	72
19A02022	20 x 22	28	30	15	16	170	291	8	72
19A02123	21 x 23	29	31	15	17	185	346	6	54
19A02426	24 x 26	33	35	19	21	190	425	4	36
19A02528	25 x 28	34	37	19	21	205	497	4	24
19A02729	27 x 29	37	39	21	22	210	590	2	12
19A03032	30 x 32	40	42	22	26	210	680	2	12

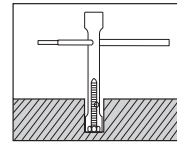
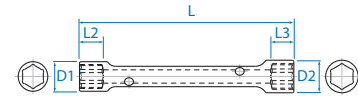

• Double end socket wrench for the hollow tube design, a long-type screw may be used.

19A0-09

KT NO.	L	Ø	Ø1	Ø2	Ø3	Ø4	Applied to socket wrench sizes
19A0-09	220	7.8	6.75	4.75	5.75	2.8	19A00607~19A02022
19A0-15	300	12.7	11.75	9.75	-	-	19A02123~19A03032

19A0-15

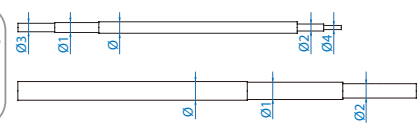

Flexible Speed Wrench & Set

KT No. & D1

3730M

- Flexible head, open end and ratchet ring - wrench
- 5° gear action (72 teeth)
- Chrome vanadium alloy steel
- Chrome plated

KT NO.	Size	D1	D2	H1	H2	L	g	kg	mm
373008M	8	16.2	16.7	4.3	6.5	127.0	35	12	432
373009M	9	18.2	18.6	4.6	6.9	131.5	42	12	384
373010M	10	20.3	20.0	5.0	7.3	136.0	55	12	384
373011M	11	22.5	21.8	5.4	7.7	141.0	65	10	320
373012M	12	24.3	23.0	5.8	8.2	147.5	80	10	240
373013M	13	26.8	25.2	6.1	8.6	154.0	93	10	240
373014M	14	28.7	26.8	6.4	9.0	160.0	109	10	200
373015M	15	30.5	28.3	6.9	9.4	169.0	129	10	160
373016M	16	32.9	29.8	7.2	9.9	179.0	149	10	160
373017M	17	34.5	31.8	7.6	10.3	190.0	178	10	160
373018M	18	37.0	32.8	8.0	10.7	203.0	201	10	160
373019M	19	39.2	33.9	8.6	11.2	215.0	231	10	80
373021M	21	46.0	40.0	9.0	13.0	274.0	392	6	54
373022M	22	46.0	40.0	9.0	13.0	274.0	392	6	54
373024M	24	52.2	46.0	10.0	14.5	296.0	547	6	54

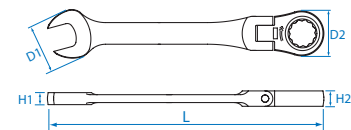
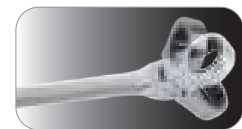

Flexible Speed Wrench & Set

13012MR

Blow case size (mm) :
275 x 310 x 65 (1.68 Cuft)



12
PC.

Contents

2.17 1 / 6



3730M

8, 9, 10, 11, 12, 13, 14, 15, 16, 17, 18, 19

13013MR

Blow case size (mm) :
303 x 228 x 50 (1.35 Cuft)



13
PC.

Contents

1.66 1 / 8



3730M

8, 10, 12, 13, 14, 16, 17, 18, 19



02H



02R



03R



04R

Speed Wrench & Set

KT No. & D1

3731M

- Open end and ratchet ring - wrench
- 5° gear action (72 teeth)
- Chrome vanadium alloy steel
- Chrome plated

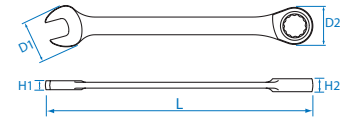

KT NO.	Size mm	D1 mm	D2 mm	H1 mm	H2 mm	L mm		
373108M	8	16.7	17.0	4.0	6.5	140.0	30	12 / 384
373109M	9	18.7	18.6	4.4	6.9	149.0	39	12 / 384
373110M	10	20.8	20.2	4.8	7.3	158.0	49	12 / 240
373111M	11	23.0	22.0	5.2	7.7	165.0	60	12 / 240
373112M	12	24.6	23.4	5.5	8.2	171.0	74	12 / 240
373113M	13	26.8	25.5	5.8	8.6	178.0	83	10 / 160
373114M	14	29.0	26.9	6.2	9.0	190.0	98	10 / 160
373115M	15	31.0	28.3	6.5	9.4	199.0	123	10 / 160
373116M	16	33.0	29.8	6.8	9.9	208.0	134	10 / 160

KT NO.	Size mm	D1 mm	D2 mm	H1 mm	H2 mm	L mm		
373117M	17	35.5	31.8	7.2	10.3	225.0	164	6 / 60
373118M	18	37.5	32.7	7.7	10.7	236.0	193	6 / 60
373119M	19	39.4	34.0	8.2	11.2	247.0	215	6 / 60
373121M	21	45.8	40.1	9.0	13.0	287.8	322	6 / 54
373122M	22	45.8	40.1	9.0	13.0	287.8	315	6 / 54
373124M	24	51.8	46.5	10.0	14.5	321.0	476	6 / 54
373127M	27	56.4	52.4	10.5	15.5	356.6	637	6 / 36
373130M	30	62.7	58.1	11.4	17.0	400.7	856	4 / 24
373132M	32	66.4	61.9	12.5	17.5	423.5	1011	4 / 24

KT NO. PC.

Contents

12107MRN	7	10, 11, 12, 14, 15, 17, 19	0.91	1 / 24
12107MRN01	7	8, 10, 11, 12, 13, 17, 19	0.84	1 / 24
12114MRN	14	8, 9, 10, 11, 12, 13, 14, 15, 16, 17, 18, 19, 22, 24	2.50	1 / 12
12112MRN	12	8, 9, 10, 11, 12, 13, 14, 15, 17, 19, 22, 24	1.95	1 / 8



► Teton pouch bag

13113MR

Blow case size (mm) :
303 x 228 x 50 (1.35 Cuft)

Contents

1.64 1 / 8

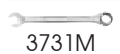

3731M

8, 10, 12, 13, 14, 16, 17, 18, 19



02H



02R



03R



04R



13
PC.

Ringstop Speed Wrench

373AM

- Ringstop function
- Open end and ratchet ring - wrench
- 5° gear action (72 teeth)
- Reversible
- Take - up : 13°
- Chrome vanadium alloy steel
- Chrome plated

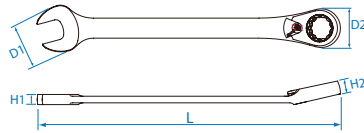
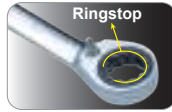
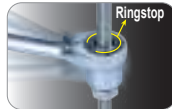

KT NO.	Size mm	D1 mm	D2 mm	H1 mm	H2 mm	L mm		
373A07M	7	16.7	16.6	4.6	6.5	140	12 / 384	
373A08M	8	16.7	16.6	4.6	6.5	140	12 / 384	
373A09M	9	18.8	18.4	4.9	6.9	150	12 / 384	
373A10M	10	20.8	20.0	5.3	7.3	159	12 / 240	
373A11M	11	23.0	21.8	5.6	7.7	165	12 / 240	
373A12M	12	25.0	22.7	6.0	8.2	172	12 / 240	
373A13M	13	27.1	24.7	6.4	8.6	178	10 / 160	
373A14M	14	29.2	27.0	6.8	9.0	191	10 / 160	
373A15M	15	31.3	28.3	7.0	9.4	200	10 / 160	
373A16M	16	33.4	30.0	7.2	9.9	208	10 / 60	
373A17M	17	35.5	31.8	7.7	10.3	226	6 / 60	
373A18M	18	37.6	32.6	8.2	10.7	237	6 / 60	
373A19M	19	39.7	33.8	8.8	11.2	248	6 / 60	
373A21M	21	46.0	40.0	9.0	13.0	290	6 / 54	
373A22M	22	46.0	40.0	9.0	13.0	290	6 / 54	
373A24M	24	52.2	46.0	10.0	14.5	323	6 / 54	

Speed Wrench

KT No. & D1



3732S

- Open end and ratchet ring - wrench
- 5° gear action (72 teeth)
- Reversible
- Take - up : 13°
- Chrome vanadium alloy steel
- Chrome plated

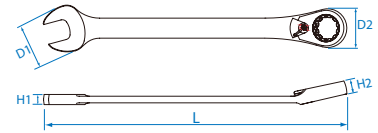

KT NO.	Size inch	D1 mm	D2 mm	H1 mm	H2 mm	L mm		
373210S	5/16	16.7	16.6	4.6	6.5	140	32	12 / 384
373212S	3/8	20.8	20.0	5.3	7.3	159	48	12 / 240
373214S	7/16	23.8	21.8	5.6	7.7	165	60	12 / 240
373216S	1/2	27.1	24.7	6.4	8.6	178	86	10 / 160
373218S	9/16	29.2	27.0	6.8	9.0	191	102	10 / 160
373220S	5/8	33.4	30.0	7.2	9.9	208	146	10 / 60
373222S	11/16	35.5	31.8	7.7	10.3	226	169	6 / 60
373224S	3/4	39.7	33.8	8.8	11.2	248	216	6 / 60
373228S	7/8	46.0	40.0	9.0	13.0	290	364	6 / 54
373230S	15/16	52.5	46.0	10.0	14.5	323	496	6 / 54

Speed Wrench Set

KT NO.	PC.	Contents		
122A07MRN01	7	8, 10, 11, 12, 13, 17, 19	0.91	1 / 24
122A07MRN02	7	8, 10, 12, 13, 14, 17, 19	0.97	1 / 16
122A14MRN	14	8, 9, 10, 11, 12, 13, 14, 15, 16, 17, 18, 19, 22, 24	2.50	1 / 12
122A12MRN	12	8, 9, 10, 11, 12, 13, 14, 15, 17, 19, 22, 24	2.06	1 / 8
12207SRN	7	3/8, 7/16, 1/2, 9/16, 5/8, 11/16, 3/4	0.91	1 / 24



► Teton pouch bag

132A13MR

Blow case size (mm) :
303 x 228 x 50 (1.35 Cuft)

Contents

1.64 1 / 8



373AM 8, 10, 12, 13, 14, 16, 17, 18, 19



02H



02R



03R



04R



13
PC.

Double End Speed Wrench

3736M

- 5° gear action (72 teeth)
- Chrome vanadium alloy steel
- Chrome plated

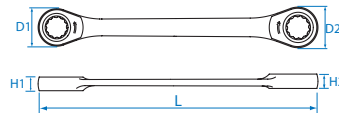

KT NO.	Size mm	D1 mm	D2 mm	H1 mm	H2 mm	L mm	g	Box/Case
37360809M	8 x 9	16.8	20.2	6.5	6.9	128	42	10 / 320
37361011M	10 x 11	20.2	21.8	7.3	7.7	150	61	10 / 200
37361013M	10 x 13	20.2	24.8	7.3	8.6	150	75	10 / 200
37361213M	12 x 13	23.0	24.8	8.2	8.6	170	88	10 / 200
37361415M	14 x 15	26.5	29.5	9.0	9.4	190	126	10 / 160
37361618M	16 x 18	29.5	33.5	9.9	10.7	210	182	10 / 120
37361719M	17 x 19	31.5	33.5	10.3	11.2	230	206	10 / 120

Double End Speed Wrench & Set

3737M

- 5° gear action (72 teeth)
- Reversible
- Take-up :13°
- Chrome vanadium alloy steel
- Chrome plated

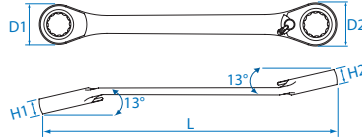

KT NO.	Size mm	D1 mm	D2 mm	H1 mm	H2 mm	L mm	g	Box/Case
37370607M	6 x 7	14.2	17.2	6.3	6.5	115	32	10 / 320
37370809M	8 x 9	16.8	20.2	6.5	6.9	128	42	10 / 320
37371011M	10 x 11	20.2	21.8	7.3	7.7	150	59	10 / 200
37371213M	12 x 13	23.0	24.8	8.2	8.6	170	87	10 / 200
37371415M	14 x 15	26.5	29.5	9.0	9.4	190	127	10 / 160
37371618M	16 x 18	29.5	33.5	9.9	10.7	210	178	10 / 120
37372123M	21 x 23	40.0	46.0	13	14.5	260	413	8 / 64
37372224M	22 x 24	40.0	46.0	13	14.5	260	385	8 / 64

Stubby Speed Wrench & Set

3738M

- Open-ended and ratchet ring-wrench
- 5° gear action (72 teeth)
- Chrome vanadium alloy steel
- Chrome plated

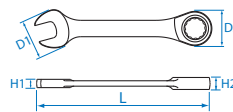

KT NO.	Size mm	D1 mm	D2 mm	H1 mm	H2 mm	L mm	g	Box/Case
373811M	11	23.8	23.0	5.1	8.0	103	55	15 / 360
373812M	12	26.0	24.8	5.3	8.5	106	65	15 / 360

KT NO.	Size mm	D1 mm	D2 mm	H1 mm	H2 mm	L mm	g	Box/Case
373813M	13	27.5	26.1	5.6	8.7	108	75	15 / 360
373814M	14	30.5	27.6	6.0	9.3	115	88	15 / 360
373815M	15	31.8	29.2	6.3	9.9	119	104	15 / 360

Open-side Speed Wrench & Set

KT No. & D1



3721M

- Open-side speed wrench
- Torque rating exceeds ANSI specifications by 30% plus
- The special ratcheting open end design will not slip off the screw when torque is applied
- Chrome vanadium alloy steel
- Chrome plated

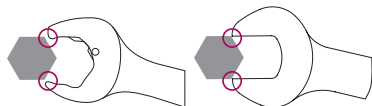

KT NO.	Size mm	D1 mm	D2 mm	H1 mm	H2 mm	L mm	g	kg	ctn
372111M	11	25.4	17.5	6.6	7.4	168	68	12	288
372112M	12	26.3	19.2	7.5	7.9	174	83	12	288
372115M	15	32.8	23.6	8.5	9.7	200	143	10	120
372116M	16	34.9	23.6	9.0	10.8	207	171	10	120
372118M	18	39.0	28.0	9.8	11.2	239	220	10	100

3721S

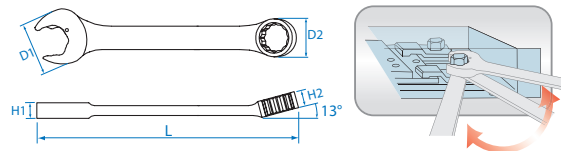

KT NO.	Size inch	D1 mm	D2 mm	H1 mm	H2 mm	L mm	g	kg	ctn
372110S	5/16	17.8	13.3	5.0	6.0	136	38	12	384
372112S	3/8	22.2	16.6	6.0	7.2	161	59	12	288
372114S	7/16	25.4	17.5	6.6	7.4	168	68	12	288
372116S	1/2	28.2	20.3	7.9	8.6	180	97	10	240
372118S	9/16	31.5	21.3	8.5	9.2	193	120	10	120
372120S	5/8	34.9	25.6	9.0	10.8	207	163	10	120
372122S	11/16	37.4	28.1	9.5	10.9	227	184	10	100
372124S	3/4	41.2	29.3	9.8	12.2	250	246	6	60



► Teton pouch bag

KT NO.	PC.	Contents	kg	ctn
14108SRN	8	3721S 5/16, 3/8, 7/16, 1/2, 9/16, 5/8, 11/16, 3/4	1.11	1 / 16

Speed Wrench Adapter

H / R

KT NO.	Apply to speed wrench	Function
02H		10 mm 1/4" Bit
02R		10 mm 1/4" drive
03R		13 mm 3/8" drive
25H		13 mm 5/16" Bit
04R		19 mm 1/2" drive



WRENCHES

Podger Ratchet Wrench

1500

- Double sizes ratchet head
- Reversible switch for tightening and loosening the screw
- Taper end bar
- For scaffolding construction work
- 32 teeth

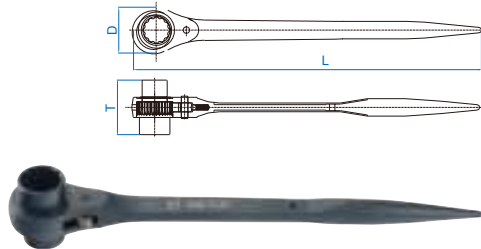

KT NO.	mm	T mm	D mm	L mm	g	kg	boxes
15001012P	10 x 12	38	31	241	209.4	2 / 120	
15001113P	11 x 13	38	31	241	209.4	2 / 120	
15001214P	12 x 14	38	31	241	220	2 / 120	
15001317P	13 x 17	45	34	280	280	2 / 80	
15001415P	14 x 15	45	34	280	280	2 / 80	
15001417P	14 x 17	45	34	280	280	2 / 80	
15001719P	17 x 19	50	42	320	506	2 / 40	
15001721P	17 x 21	50	42	320	506	2 / 40	
15001921P	19 x 21	50	42	320	506	2 / 40	
15001922P	19 x 22	50	42	320	506	2 / 40	
15001924P	19 x 24	56	51.5	365	820	2 / 24	
15002123P	21 x 23	56	51.5	365	820	2 / 24	
15002224P	22 x 24	56	51.5	365	830	2 / 24	
15002326P	23 x 26	56	51.5	365	830	2 / 24	
15002427P	24 x 27	56	51.5	365	870	2 / 24	
15002430P	24 x 30	63	61.5	402	1110	2 / 16	
15002632P	26 x 32	63	61.5	402	1150	2 / 16	
15002730P	27 x 30	63	61.5	402	1150	2 / 16	
15002732P	27 x 32	63	61.5	402	1150	2 / 16	
15003032P	30 x 32	63	61.5	402	1150	2 / 16	
15003236P	32 x 36	67	67	450	1525	2 / 8	
15003638P	36 x 38	67	67	450	1525	2 / 8	
15003641P	36 x 41	67	67	450	1525	2 / 8	
15003841P	38 x 41	67	67	450	1470	2 / 8	



Angled Socket Wrench & Set

1084

5084



- Conic profile and thin walled
- Convenient to facilitate the force-depth objects
- Chrome plated

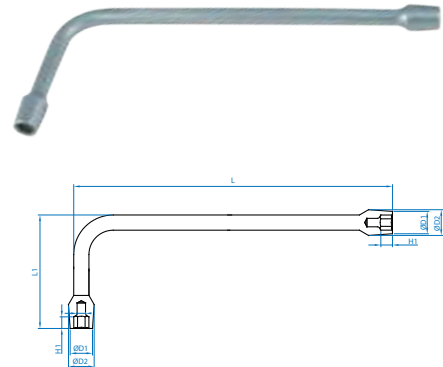

KT NO.	mm	D1 mm	D2 mm	H1 mm	L1 mm	L mm	g	kg	boxes
1084-08	8	12.5	14.0	10	88	230	152	12 / 48	
1084-09	9	14.0	15.5	10	88	230	153	12 / 48	
1084-10	10	15.0	16.5	10	88	230	187	10 / 40	
1084-11	11	16.0	17.5	11	88	230	192	10 / 40	
1084-12	12	17.4	19.5	12	98	245	298	6 / 30	
1084-13	13	18.9	21.0	12	98	245	313	6 / 30	
1084-14	14	19.8	22.0	12	98	260	332	6 / 24	
1084-15	15	21.7	24.0	13	98	260	344	6 / 24	
1084-16	16	22.2	24.5	13	98	260	350	6 / 24	
1084-17	17	24.5	27.0	14	98	260	475	6 / 24	
1084-18	18	25.5	28.0	15	98	260	484	6 / 24	
1084-19	19	27.1	30.0	15	98	260	588	6 / 24	

KT NO.	inch	D1 mm	D2 mm	H1 mm	L1 mm	L mm	g	kg	boxes
5084-16	1/2	18.9	21.0	23	12	245	315	6 / 30	
5084-18	9/16	19.8	22.0	23	12	260	338	6 / 24	



► Nylon pouch bag

KT NO.	PC.	Contents	kg	boxes
1842MR	12	1084 8, 9, 10, 11, 12, 13, 14, 15, 16, 17, 18, 19	4.2	1 / 6

Angled Socket Wrench & Set

1080



1081



- Angle and through-hole design
- Deep concave at one side and open end socket at the other, easily fit over protruding studs
- Chrome plated
- ISO 2236

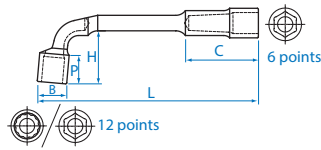
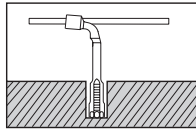
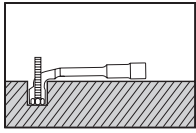

KT NO.	mm	B mm	P mm	H mm	C mm	L mm	g	kg
1080-06	6	11.0	7.0	18.5	29	110	43	12 / 240
1080-07	7	11.5	8.0	21.0	30.5	114	57	12 / 240
1080-08	8	13.0	10.0	21.5	30	120	68	12 / 216
1080-09	9	14.0	10.0	22.0	33	125	85	12 / 216
1080-10	10	15.0	11.0	25.5	35	131	102	6 / 60
1080-11	11	16.5	12.0	26.5	37	137	125	6 / 60
1080-12	12	17.5	12.0	27.0	40	144	143	6 / 60
1080-13	13	19.0	14.0	30.0	47	152.5	173	6 / 60
1080-14	14	20.0	14.0	33.0	48	160	191	6 / 60
1080-15	15	21.5	15.0	35.0	50	174	236	6 / 60
1080-16	16	22.5	17.0	39.5	54	185	281	6 / 60
1080-17	17	24.0	18.0	39.5	56	197	314	6 / 60
1080-18	18	25.0	19.5	42.0	58	211	336	4 / 40
1080-19	19	26.5	20.5	45.0	62	218	374	4 / 40
1080-20	20	27.5	21.5	45.0	63	222	445	2 / 20
1080-21	21	29.0	23.5	49.0	65	231	488	2 / 20
1080-22	22	30.0	23.5	49.0	67	247	537	2 / 16
1080-23	23	31.5	24.5	54.0	74	255	600	2 / 16
1080-24	24	32.5	25.5	56.0	77	266	657	2 / 16
1080-25	25	34.0	25.5	58.0	79	278	692	2 / 16
1080-26	26	35.0	25.5	59.0	80	289	863	2 / 16
1080-27	27	36.5	27.5	59.0	84	299	942	2 / 16
1080-28	28	37.5	27.5	60.0	86	310	1080	2 / 16
1080-29	29	39.0	28.5	62.0	90	319	1167	2 / 16
1080-30	30	40.0	28.5	65.0	93	332	1194	2 / 12
1080-32	32	42.5	28.5	69.0	95	353	1355	2 / 12

KT NO.	mm	B mm	P mm	H mm	C mm	L mm	g	kg
1081-06	6	11.0	7.0	18.5	29	110	44	12 / 240
1081-07	7	11.5	8.0	21.0	30.5	114	54	12 / 240
1081-08	8	13.0	10.0	21.5	30	120	69	12 / 216
1081-09	9	14.0	10.0	22.0	33	125	88	12 / 216
1081-10	10	15.0	11.0	25.5	35	131	105	6 / 60
1081-11	11	16.5	12.0	26.5	37	137	132	6 / 60
1081-12	12	17.5	12.0	27.0	40	144	148	6 / 60
1081-13	13	19.0	14.0	30.0	47	152.5	178	6 / 60
1081-14	14	20.0	14.0	33.0	48	160	185	6 / 60
1081-15	15	21.5	15.0	35.0	50	174	245	6 / 60
1081-16	16	22.5	17.0	39.5	54	185	285	6 / 60
1081-17	17	24.0	18.0	39.5	56	197	315	6 / 60
1081-18	18	25.0	19.5	42.0	58	211	355	4 / 40
1081-19	19	26.5	20.5	45.0	62	218	425	4 / 40
1081-20	20	27.5	21.5	45.0	63	222	441	2 / 20
1081-21	21	29.0	23.5	49.0	65	231	483	2 / 20
1081-22	22	30.0	23.5	49.0	67	247	589	2 / 16
1081-23	23	31.5	24.5	54.0	74	255	661	2 / 16
1081-24	24	32.5	25.5	56.0	77	266	658	2 / 16
1081-25	25	34.0	25.5	58.0	79	278	798	2 / 16
1081-26	26	35.0	25.5	59.0	80	289	825	2 / 16
1081-27	27	36.5	27.5	59.0	84	299	914	2 / 16
1081-28	28	37.5	27.5	60.0	86	310	1005	2 / 16
1081-29	29	39.0	28.5	62.0	90	319	1161	2 / 16
1081-30	30	40.0	28.5	65.0	93	332	1214	2 / 12
1081-32	32	42.5	28.5	69.0	95	353	1362	2 / 12



► MRN / SRN : Teton pouch bag



► MR / SR : Nylon pouch bag



► Color box



KT NO.	PC.	Contents	Package	g	kg
1805MR	5	10, 11, 13, 14, 17	Color box	1.12	1 / 22
1808MR	8	8, 10, 11, 12, 13, 14, 17, 19	Nylon	1.73	1 / 18
1812MR	12	8, 10, 11, 12, 13, 14, 16, 17, 18, 19, 22, 24	Nylon	3.38	1 / 4
1826MR	26	6, 7, 8, 9, 10, 11, 12, 13, 14, 15, 16, 17, 18, 19, 20, 21, 22, 23, 24, 25, 26, 27, 28, 29, 30, 32	Color box	14.0	1 / 2
1912MR	12	8, 10, 11, 12, 13, 14, 16, 17, 18, 19, 22, 24	Nylon	3.38	1 / 4
1912MRN	12	8, 10, 11, 12, 13, 14, 16, 17, 18, 19, 22, 24	Teton	3.38	1 / 4
1926MR	26	6, 7, 8, 9, 10, 11, 12, 13, 14, 15, 16, 17, 18, 19, 20, 21, 22, 23, 24, 25, 26, 27, 28, 29, 30, 32	Color box	15.0	1 / 2



WRENCHES

Adjustable Wrench

3611

- Chrome vanadium alloy steel
- Polish, phosphate & chrome plated
- DIN 3117

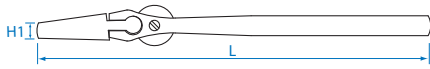

3611R



3611HR



3611P



3611HP

KT NO.	mm	H1 mm	L mm	g	Box
3611-06R	20	7	150	136	12 / 108
3611-08R	25	8	200	245	12 / 48
3611-10R	30	11	250	415	10 / 60
3611-12R	35	13	300	713	5 / 40
3611-06P	20	7	150	127	12 / 108
3611-08P	25	8	200	246	12 / 48
3611-10P	30	11	250	415	10 / 60
3611-12P	35	13	300	691	5 / 40

KT NO.	mm	H1 mm	L mm	g	Box
3611-15HR	43	13	365	1351	1 / 20
3611-18HR	52	18	450	1877	1 / 6
3611-24HR	62	23	600	3720	1 / 6
3611-15HP	43	13	365	1348	1 / 20
3611-18HP	52	18	450	1750	1 / 6
3611-24HP	62	23	600	3669	1 / 6

Reversible Jaw Adjustable Wrench

3614-08R

- Chrome vanadium alloy steel
- Dual function wide jaws can be used as an adjustable wrench or pipe Wrench. On one side, the jaw is flat for traditional usage to avoid damaging the parts.
- On the other side, the jaw is finely serrated for powerful tightening on tubes and other parts requiring strong grip and high torque.
- Super wide jaw opening, 50% wider than regular adjustable wrenches
- Deep throat, 30% longer jaws than traditional adjustable wrenches
- Screw pin with front side metric or SAE scale
- 15°, perfectly matched knurl and teeth of jaw for smooth running
- TPR handle with end hole button

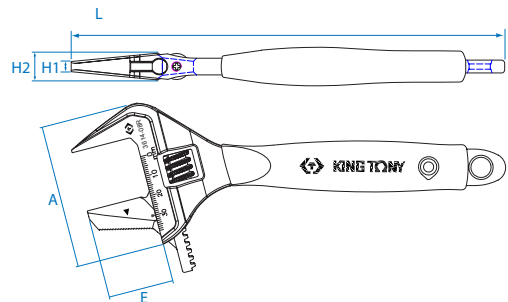

KT NO.	mm	A mm	E mm	H1 mm	H2 mm	L mm	g	Box
3614-08R	38	69	32.4	5.7	13.9	212	298.6	4 / 40

Ratcheting Adjustable Wrench

3631-10R

- Chrome vanadium alloy steel
- Magic button to switch ratchet function on/ off
- Wider jaw opening, comfortable & durability
- Excellent in each movement of knurl, tension enhanced and precise
- Patented, more than 130% of ASME standard



KT NO.	mm	Overall length mm	g	Box
3631-10R	32	257	470	6 / 36

Double Sides Self-Adjusting Wrench

3616-10

- Self-locking function grip, ideal for fastener 8~32mm
- Anti-slip teeth effective on worn screws
- Slim jaw allows for working in confined area
- Multi-purpose to all shape of fastener

- Spline 12 points
- Square
- Torx
- Hexagon
- 70% Rounded bolt



KT NO.	Capacity mm		
3616-10	8~17 14~32	466	6 / 36

Rapid Pipe Wrench

3616S

- Multi-purpose for all shape of fasteners and pipes
- Anti-slip teeth effective on worn screws
- Strong and durable CR-MO material



KT NO.	Capacity mm		
3616S-08P	12-28	345	1 / 48
3616S-14P	20-48	883	1 / 20



- Easy and quick to operate by one hand
- Rapid ratcheting action
- Special Jaw design provides extra strong grip

Adjustable Hook Wrench

3641

- The joint is equipped with a spring washer to ensure smooth and reliable operation
- Chrome vanadium alloy steel

KT NO.	Capacity mm	L		
3641-35	13-35	174	104	12 / 144
3641-50	35-50	212	170	12 / 108
3641-80	50-80	285	395	10 / 60
3641-C0	80-120	348	689	5 / 30
3641-I0	120-180	480	1554	4 / 16

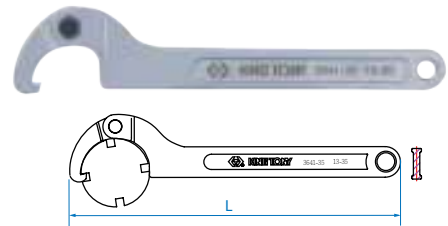

Chain Wrench

3204

- Chain wrench for oil filter



KT NO.	Overall length Inch mm	Capacity(M) mm		
3204	8-3/4 225	∅ 60~140	411	50

Strap Wrench

3203

- Strap wrench for oil filter



KT NO.	Overall length Inch mm	Capacity(M) mm		
3203	8-3/4 223	∅ 60~140	276	50
320300		Strap	46	80
3203A0	8-3/4 223	∅ 60~260	300	45
320301		Strap	73	80



Polyester Strap Wrench

32067A

- Aluminum alloy handle and strong polyester strap for tight grip
- Suitable for oil filter or any polished pipe



KT NO.	Overall Length		Capacity mm	Scales	Pkg./Crate
	inch	mm			
32067A	12	295	∅ 60~180	344	25 / 50
3206A00	Polyester strap			35	25 / 50

Wheel Nut Wrench

1991

- For most car wheel nuts in metric
- Chrome vanadium alloy steel
- Chrome plated
- DIN 3119, ISO 6788

KT NO.	■	○	L mm	Scales	Pkg./Crate
	inch	mm			
19911722	1/2	17, 19, 21, 22	400	1700	6
199104R	1/2	19	34	84	10 / 240

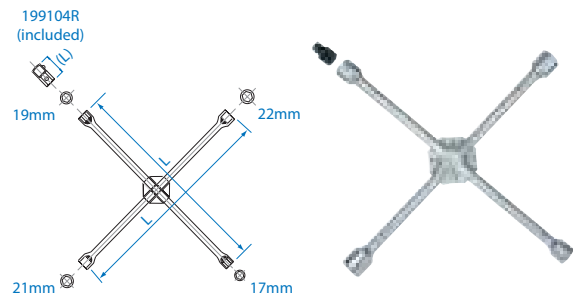

1993

- Designed for removing wheel nuts on cars and heavy vehicles
- Replaceable bit on wrenches featuring a square drive
- Chrome vanadium alloy steel
- Chrome plated

KT NO.	■	○	L mm	Scales	Pkg./Crate
	inch	mm			
19932427	3/4	24, 27, 32	700	4333	4

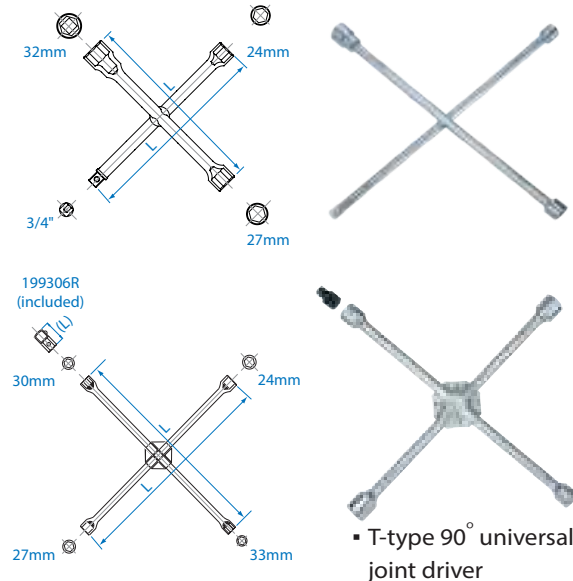

KT NO.	■	○	L mm	Scales	Pkg./Crate
	inch	mm			
19932433	3/4	24, 27, 30, 33	700	5.02	2
199306R	3/4	30	48	0.21	-

T-type 90° universal joint driver

Assembling Wheel Nut Wrench

1996

PAT. 192461

- For most car wheel nuts in metric
- Chrome vanadium alloy steel
- Chrome plated

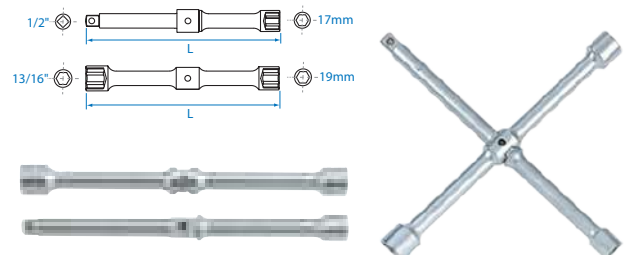

KT NO.	○	■	○	L mm	Scales	Pkg./Crate
	inch	inch	mm			
19961721	13/16	1/2	17, 19	300	1100	20

Double-End Truck Wrench & Set

1999A

- Chrome vanadium alloy steel
- Chrome plated



1999



1999R



Set KT NO.	g	Box/Kit	Wrench KT NO.	Size mm	Ø mm	Overall length mm	Tommy Bar KT NO.	Overall length mm
19991921A	1183	1 / 20	19991921	19 x 21	16	300	19980016	300
19992224A	2330	1 / 8	19992224	22 x 24	20	406	199920R	400
19992427A	2673	1 / 8	19992427	24 x 27	20	406	199920R	400
19992432A	2360	1 / 8	19992432	24 x 32	20	406	199920R	400
19992730A	2740	1 / 8	19992730	27 x 30	20	406	199920R	400
19992732A	2762	1 / 8	19992732	27 x 32	20	406	199920R	400
19992733A	2796	1 / 8	19992733	27 x 33	20	406	199920R	400
19992833A	2440	1 / 8	19992833	28 x 33	20	406	199920R	400
19993032A	2853	1 / 8	19993032	30 x 32	20	406	199920R	400
19993233A	2875	1 / 8	19993233	32 x 33	20	406	199920R	400
19993238A	3055	1 / 4	19993238	32 x 38	20	406	199920R	400
19993821A	3794	3	19993821	○ 38 x ○ 21 SQ.	25	406	199925R	595
19993822A	3794	3	19993822	○ 38 x ○ 22 SQ.	25	406	199925R	595
19994121LA	4074	3 / 3	19994121L	○ 41 x ○ 21 SQ.	25	450	199925R	595

T-Spin Lug Wrench Set

4503MR01

- Fast spinning action extension wrench
- Reach deep area with soft grip handle
- Suitable for passenger vehicles

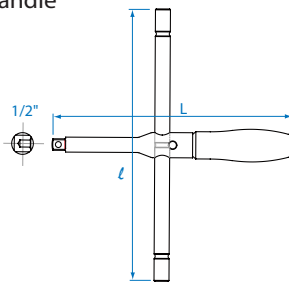

4506MR

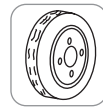

4 PC.



4503MR01



6 PC.



4506MR

KT NO.	Size	l mm	L mm	g	Box
4503MR01	■ 1/2"	300	265	1.36	12
	○ 4335MR 19, 21 mm				
4506MR	■ 1/2"	300	265	1.56	10
	○ 4335MR 17, 19, 21, 23 mm				



WRENCHES

T-type Deep Socket Wrench

115HM

- Shank material - chrome vanadium alloy steel
- Shank finishing - chrome plated
- Grip material - PP

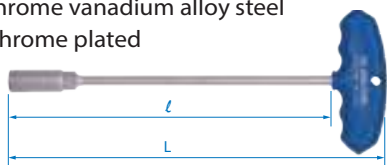

KT NO.	Size mm	ℓ mm	L mm	g	Box
115H05M-10	5	260	300	127	12 / 96
115H06M-10	6	260	300	147	12 / 96
115H07M-10	7	260	300	162	12 / 96
115H08M-10	8	260	300	158	12 / 96
115H09M-10	9	260	300	161	12 / 96
115H10M-10	10	260	300	170	12 / 96
115H11M-10	11	260	300	203	12 / 96
115H12M-10	12	260	300	205	12 / 96
115H13M-10	13	260	300	205	12 / 96
115H08M-14	8	350	394	212	10 / 60
115H10M-14	10	350	394	221	10 / 60
115H13M-14	13	350	394	233	8 / 32

1184M

- T-shaped deep socket wrench
- Chrome vanadium alloy steel
- DIN 475

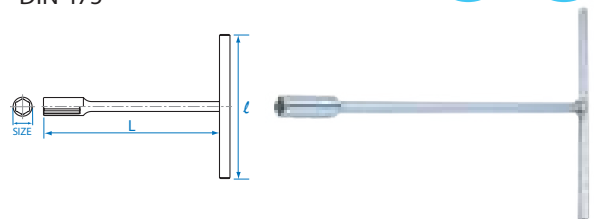

KT NO.	Size mm	ℓ mm	L mm	g	Box
118406M	6	120	190	59	10 / 40
118407M	7	120	190	77	10 / 40
118408M	8	200	300	306	10 / 60
118409M	9	200	300	306	10 / 60
118410M	10	200	300	317	10 / 60
118411M	11	200	300	323	10 / 60
118412M	12	200	300	326	10 / 60
118413M	13	200	300	333	10 / 60
118414M	14	200	300	344	10 / 60
118417M	17	250	300	599	6 / 36

T-type Standard Socket Wrench

1185M

- T-shaped standard socket wrench
- Chrome vanadium alloy steel
- DIN 475

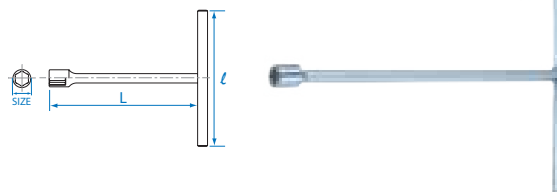

KT NO.	Size mm	ℓ mm	L mm	g	Box
118508M	8	200	250	186	10 / 100
118509M	9	200	250	230	10 / 100
118510M	10	200	250	230	10 / 100
118511M	11	200	250	234	10 / 100
118512M	12	250	250	390	10 / 60

KT NO.	Size mm	ℓ mm	L mm	g	Box
118513M	13	250	300	425	10 / 60
118514M	14	250	300	429	10 / 60
118517M	17	300	360	710	6 / 36
118519M	19	300	360	727	6 / 36

T-type Spark Plug Socket

1563

- T-type 25° universal spark plug socket (rubber)
- Chrome vanadium alloy steel

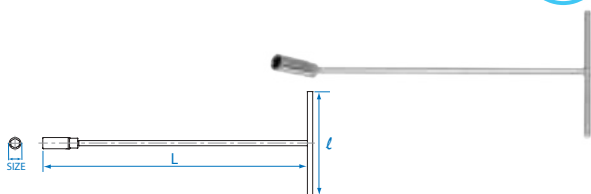

KT NO.	Size mm	ℓ mm	L mm	g	Box
15631612	16	200	300	363	10 / 40
15631615	16	200	385	400	10 / 40
15631618	16	200	460	450	10 / 40
15631818	18	200	460	450	10 / 40
15632112	21	200	300	388	10 / 40
15632115	21	200	385	438	10 / 40
15632118	21	200	460	488	10 / 40

1566

- T-type 25° universal spark plug socket with magnet
- Chrome vanadium alloy steel

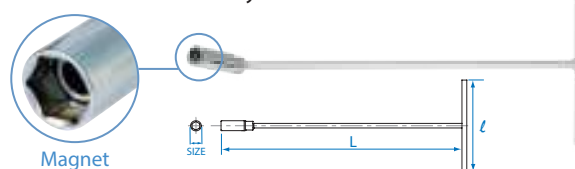

KT NO.	Size mm	ℓ mm	L mm	g	Box
15661615	16	200	385	420	10 / 40
15661618	16	200	460	460	10 / 40
15661818	18	200	460	450	10 / 40
15662115	21	200	385	460	10 / 40

T-type Universal Standard Socket Wrench

5722M

- T-type 25° universal standard socket wrench

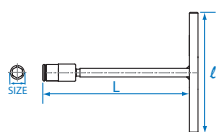

KT NO.	Size mm	l mm	L mm		
572210M	10	150	170	400	10 / 60
572212M	12	150	170	400	10 / 60

5742M

- T-type 25° universal standard socket wrench

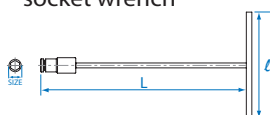

KT NO.	Size mm	l mm	L mm		
574208M	8	200	320	328	10 / 40
574212M	12	200	320	332	10 / 40
574213M	13	200	320	333	10 / 40
574214M	14	200	320	335	10 / 40

5752M

- T-type 25° universal standard socket wrench

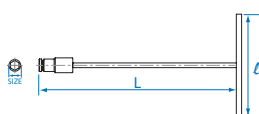

KT NO.	Size mm	l mm	L mm		
575208M	8	200	450	427	10 / 40
575210M	10	200	450	430	10 / 40
575212M	12	200	450	432	10 / 40
575213M	13	200	450	433	10 / 40
575214M	14	200	450	435	10 / 40
575217M	17	200	450	440	10 / 40

5762M

- T-type 25° universal standard socket wrench

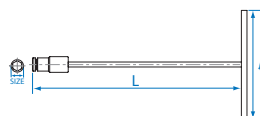

KT NO.	Size mm	l mm	L mm		
576208M	8	200	600	519	10 / 40
576210M	10	200	600	520	10 / 40
576213M	13	200	600	523	10 / 40
576214M	14	200	600	525	10 / 40
576217M	17	200	600	540	10 / 40

5774M

- T-type 90° universal standard socket wrench
- 2 PC. sliding handle for easy storage

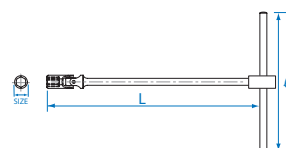

KT NO.	Size mm	l mm	L mm		
577406M	6	200	390	420	10 / 30
577407M	7	200	390	420	10 / 30
577408M	8	200	390	420	10 / 30
577409M	9	200	390	420	10 / 30
577410M	10	200	500	480	10 / 30
577411M	11	200	500	480	10 / 30
577412M	12	200	500	480	10 / 30
577413M	13	200	500	480	10 / 30
577414M	14	200	500	500	10 / 30
577415M	15	200	500	500	10 / 30
577416M	16	200	500	500	10 / 30
577417M	17	200	500	500	10 / 30
577418M	18	200	500	500	10 / 30
577419M	19	200	500	500	10 / 30

T-shaped Driver

- Chrome vanadium alloy steel
- Chrome plated

3511

3/8"

- Chrome vanadium alloy steel

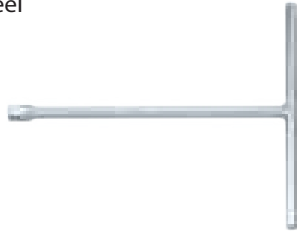
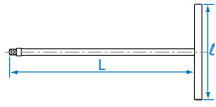

KT NO.	ℓ mm	L mm		
3511-06	170	268	324	5 / 30
3511-10	250	268	383	6 / 30

4795

1/2"

- T-type 90° universal joint driver
- Chrome vanadium alloy steel

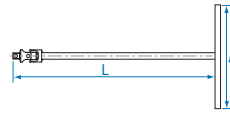

KT NO.	ℓ mm	L mm		
4795-18	200	460	567	10 / 30
4795-36	200	900	1000	10 / 20

3795

3/8"

- T-type 90° universal joint driver
- Chrome vanadium alloy steel

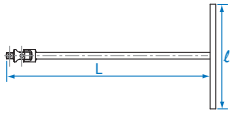

KT NO.	ℓ mm	L mm		
3795-18	200	455	425	10 / 40
3795-24	200	600	500	10 / 40
3795-30	200	750	600	10 / 30

4511

1/2"

- Chrome vanadium alloy steel

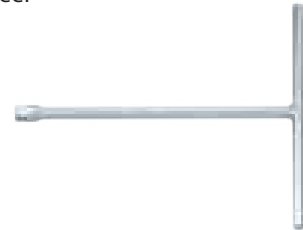
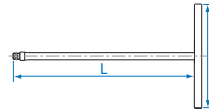

KT NO.	ℓ mm	L mm		
4511-06	170	268	396	5 / 30
4511-10	250	268	463	6 / 30

21A107

- Applied with power bit



KT NO.	Size inch	ℓ mm	L mm		
21A107	1/4	150	175	194	10 / 60

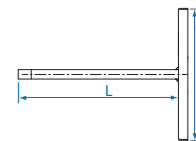



WRENCHES

PLIERS

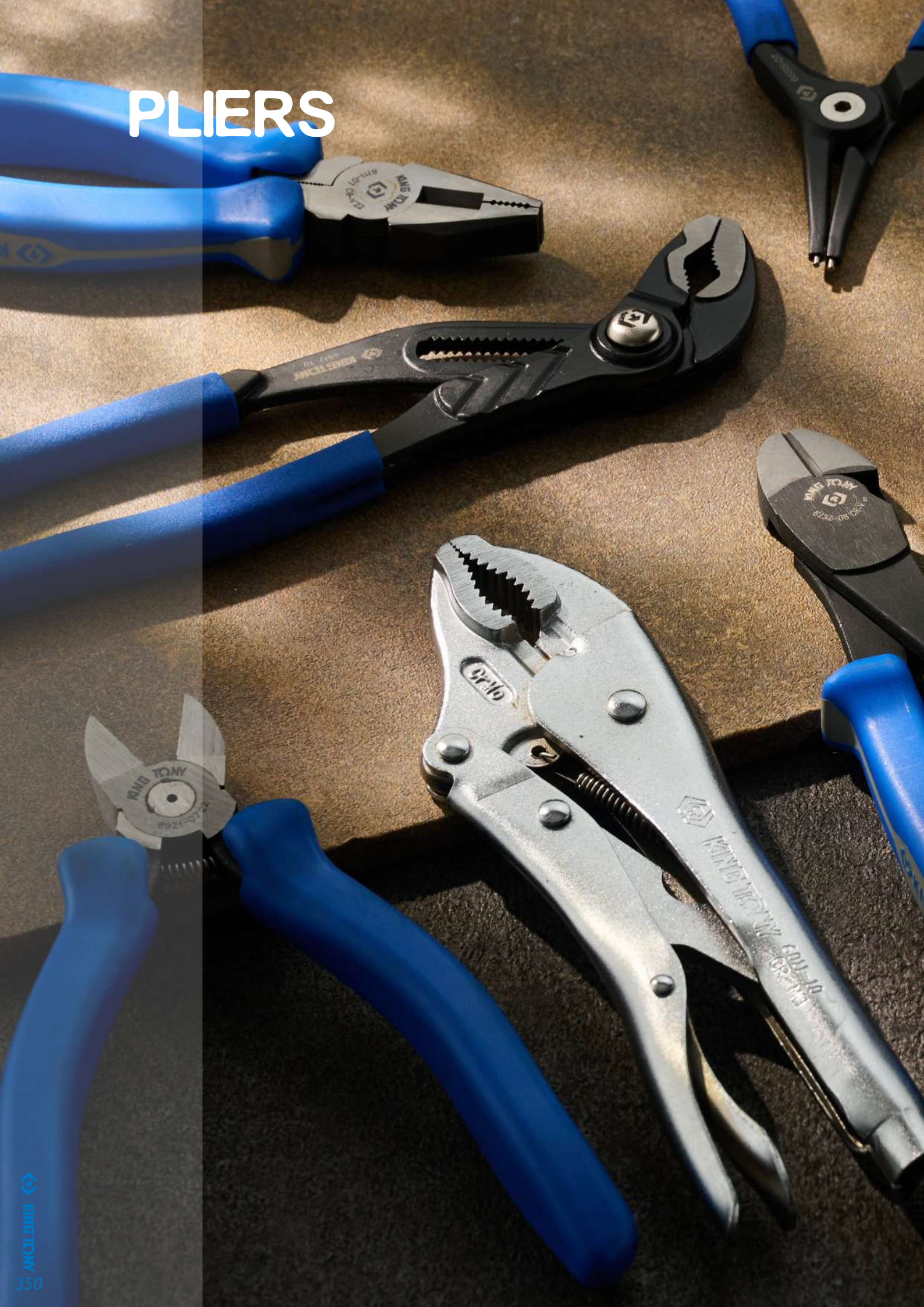



6683-07

66H5-07

8133-08

PUSH
TUNE

KING TONY
6578-10

KING TONY



High performance for cutting

A greater hardness at the edge makes it very sharp and easy to cut. Wear-resistant design is for different purposes pliers and cutters. Our high leverage combination pliers quality is tested by cutting piano wire with sharp performance.

Over 2000 times cutting result for 1.6mm piano wire (2200N/mm², HRC48)



King Tony Brand:
Wore down 0.19mm (good)



Other Brand:
Wore down 0.33mm (not good)

Exceed other brands **356%**

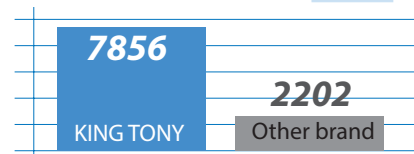

KING TONY combination pliers are sharp and triple of its life for cutting than others.

CUTTING EDGE SHAPES



With bevel (outside bevel)



With small bevel (outside bevel)



With very small bevel (outside bevel)

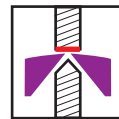

Without bevel (outside bevel)

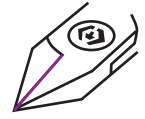

WIRE CLASSES



Soft wire



Hard wire

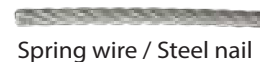

Medium hard wire



Piano wire

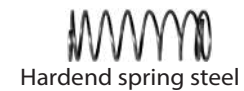

TECHNICAL BASICS



Thin serrated



Coarse serrated



With opening spring



JAWS TYPES



Round jaws



Half-round jaws



Flat & point jaws



GRIP MATERIAL

PP + TPR



item no. with "C" is made of PVC



Mini Combination Pliers

6114

- Mini type
- DIN ISO 5746

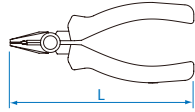

KT NO.	L		Cutting capacities				g	/	/
	inch	mm	\odot	\bullet	\bullet	\bullet			
6114-05	5	122	3.0	2.0	87	8 / 160			

Combination Pliers

6111

- Polished head
- DIN ISO 5746

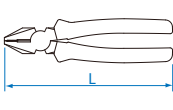

KT NO.	L		Cutting capacities				g	/	/
	inch	mm	\odot	\bullet	\bullet	\bullet			
6111-06	6-1/2	164	4.0	2.8	1.8	1.6	220	8 / 96	
6111-07	7-1/2	180	4.0	3.0	2.0	1.6	294	8 / 48	
6111-08	8-1/4	205	4.0	3.0	2.0	1.6	396	8 / 48	

Hi-leverage Combination Pliers

6112

- Hi-leverage type
- Polished head

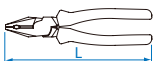

KT NO.	L		Cutting capacities				g	/	/
	inch	mm	\odot	\bullet	\bullet	\bullet			
6112-09	9	232	4.0	3.0	2.2	2.0	395	6 / 60	

Plastic Cutting Pliers

- CAUTION** In order to get a normal product life of pliers, do not cut steel wire.

6921

- European type
- Polished head

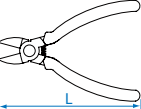

KT NO.	L		g	/	/
	inch	mm			
6921-05	5	122	106	6 / 120	
6921-06	6	155	171	6 / 72	
6921-07	7	170	268	6 / 60	
6921-05C	5	122	91	6 / 120	
6921-06C	6	155	200	8 / 96	
6921-07C	7	178	220	6 / 60	

Diagonal Cutting Pliers

6214

- Mini type

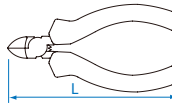

KT NO.	L		Max. mm \odot	g	/	/
	inch	mm				
6214-45	4-1/2	115	0.6	83	8 / 160	
6214-05	5	125	1.25	94	8 / 160	

6211

- European type
- DIN 5749

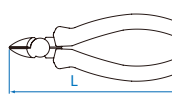

KT NO.	L		Cutting capacities				g	/	/
	inch	mm	\odot	\bullet	\bullet	\bullet			
6211-06	6-1/2	160	4.0	2.8	2.0	1.6	194	8 / 96	

6213

- Japanese type

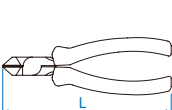

KT NO.	L		Cutting capacities \odot	Wire stripper mm	g	/	/
	inch	mm					
6213-06	6-1/2	168	1.25	1.4 / 1.6	175	8 / 96	

Heavy Duty Diagonal Cutting Pliers

6232

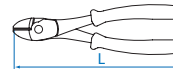

KT NO.	L		Cutting capacities				g	/	/
	inch	mm	\odot	\bullet	\bullet	\bullet			
6232-08	8	196	5.0	3.5	2.2	2.0	285	8 / 80	

6231

- Heavy duty type
- DIN ISO 5749

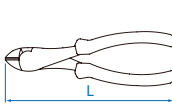

KT NO.	L		Cutting capacities				g	/	/
	inch	mm	\odot	\bullet	\bullet	\bullet			
6231-07	7-1/2	180	4.0	3.0	2.2	2.0	243	8 / 80	

Mini Long Nose Pliers

6314



- Mini type
- DIN ISO 5745

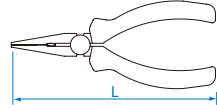

KT NO.	L		Cutting capacities				g	kg	/
	inch	mm	3.0	2.0	1.6	94			
6314-05	5-1/2	136	3.0	2.0	1.6	94	8	/	160

Long Nose Pliers

6311



- European type
- DIN ISO 5745

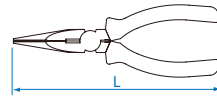

KT NO.	L		Cutting capacities				g	kg	/
	inch	mm	4.0	2.8	1.8	1.6			
6311-06	6-1/2	160	4.0	2.8	1.8	1.6	155	10	/
6311-08	8	200	4.0	3.0	2.0	1.6	220	8	/

6313



- Japanese type
- DIN ISO 5745

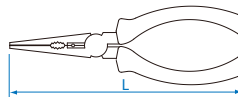

KT NO.	L		Cutting capacities				g	kg	/
	inch	mm	4.0	2.8	1.8	1.6			
6313-06	6-1/2	170	4.0	2.8	1.8	1.6	146	10	/

Extra Long Nose Pliers

6319



- Slim jaws design for gripping components in recessed areas

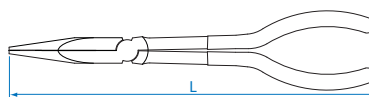

KT NO.	L		g	kg	/
	inch	mm			
6319-11C	11	280	292	6	/

Double Joint Long Nose Pliers

6329



- Double joint and slim profile, for working a greater width in a narrow space, even single-handed
- Serrated nose for good grip

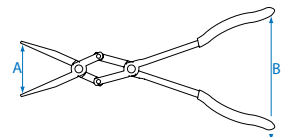
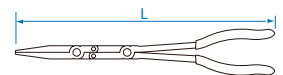

KT NO.	L		A Up on jaw capacity (mm)	B Grip width (mm)	g	kg	/
	inch	mm					
6329-13C	13	340	50	110	355	5	/

Double Joint Bent Nose Pliers

6339



- Double joint and slim profile, for working a greater width in a narrow space, even single-handed
- Serrated nose for good grip

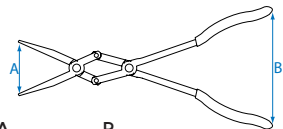
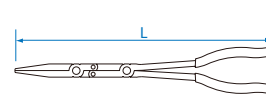

KT NO.	L		A Up on jaw capacity (mm)	B Grip width (mm)	g	kg	/
	inch	mm					
6339-13C	13	335	50	110	369	5	/

Mini Bent Nose Pliers

6334



- Mini type
- DIN ISO 5745

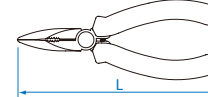

KT NO.	L		Cutting capacities			g	kg	/
	inch	mm	3.0	2.0	1.6			
6334-05	5	136	3.0	2.0	1.6	95	8	/

Bent Nose Pliers

6331



- European type
- DIN ISO 5745

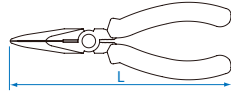

KT NO.	inch	L mm	Cutting capacities ∅ mm				Scales	Boxes
			4.0	2.8	1.8	1.6		
6331-06	6-1/2	160	4.0	2.8	1.8	1.6	142	10 / 120
6331-08	8	200	4.0	3.0	2.0	1.6	222	8 / 80

End Cutting Pliers

6411



- European type
- DIN ISO 5748

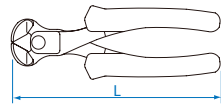

KT NO.	inch	L mm	Cutting capacities ∅ mm				Scales	Boxes
			4.0	3.0	1.6	1.6		
6411-06	6-1/2	164	4.0	3.0	1.6	1.6	273	8 / 96

6431



- European type
- DIN ISO 9242

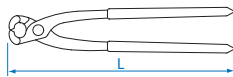

KT NO.	inch	L mm	Cutting capacities		Scales	Boxes
			∅ mm	∅ mm		
6431-10C	10	254	2.0	1.6	441	6 / 48
6431-11C	11	280	2.2	1.8	507	6 / 48

Stripping Pliers

6711



- With spring and adjusting screw

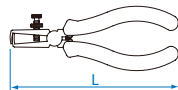

KT NO.	inch	L mm	∅ mm	Wire stripper mm ²	Scales	Boxes

Slip Joint Pliers

6463



- 2 positions adjustment
- Serrate jaws

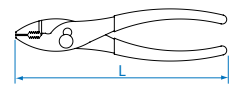
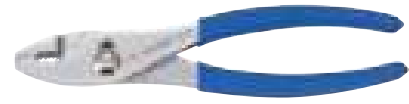

KT NO.	inch	L mm	Scales	Boxes

Quick-Lock Groove Joint Pliers

6517



- Quick lock
- Grip material-PVC
- DIN ISO 8976

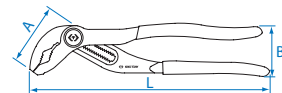

KT NO.	inch	L mm	mm	A mm	B mm	Scales	Boxes
6517-10C	10	250	60	68	56	361	6 / 48
6517-12C	12	310	70	89	73	570	5 / 40

Groove Joint Pliers

6516



- German type
- 7 positions opening
- DIN ISO 8976



6516-10



6516C

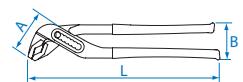

KT NO.	inch	L mm	mm	A mm	B mm	Scales	Boxes
6516-10C	10	250	36	58	61	347	6 / 48



Groove Joint Pliers

6511

- 7 positions opening
- DIN ISO 8976

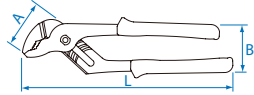

KT NO.	L		mm	mm	A	B	kg	/
	inch	mm						
6511-10	10	253	50	33	61.5	435	6 / 48	
6511-10C	10	253	50	33	58.5	400	6 / 48	
6511-13C	13	325	65	43	74.0	808	2 / 16	
6511-17C	17	425	100	58	55.0	1150	2 / 12	



6511-10



6511C



6511-17C

Bolt Cutter

6131

GS / TUV

- Chrome vanadium alloy steel
- Center cut

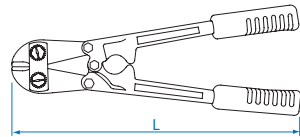

KT NO.	L		Cutting capacity 15(ø mm) HRC	Cutting capacity 35(ø mm) HRC	kg	/
	inch	mm				
6131-12	12	300	ø5	ø4	0.74	1 / 20
6131-14	14	350	ø7	ø5	1.04	1 / 20
6131-18	18	450	ø8	ø6	1.45	1 / 12
6131-24	24	600	ø10	ø8	2.32	1 / 10
6131-30	30	750	ø13	ø10	3.74	1 / 6
6131-36	36	900	ø16	ø11	5.50	1 / 5
6131-42	42	1050	ø18	ø13	8.56	1 / 3

6131P01

- Spare blade for 6131
- Center cut



KT NO.	Overall length mm	Cutting capacity 15(ø mm) HRC	Cutting capacity 35(ø mm) HRC	kg	/
6131-12P01	95 x 57	ø5	ø4	0.26	1 / 40
6131-14P01	110 x 65	ø7	ø5	0.40	1 / 40
6131-18P01	125 x 72	ø8	ø6	0.85	1 / 20
6131-24P01	150 x 86	ø10	ø8	0.87	1 / 20
6131-30P01	170 x 97	ø13	ø10	1.25	1 / 10
6131-36P01	190 x 112	ø16	ø11	1.85	1 / 10
6131-42P01	205 x 122	ø18	ø13	3.10	1 / 5

Compact Bolt Cutter

6133

- Heavy duty type
- DIN ISO 5749
- Center cut

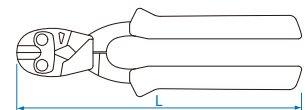

KT NO.	L		Cutting capacities				kg	/
	inch	mm	● ø mm	● ø mm	● ø mm	● ø mm		
6133-08	8	212	6.0	5.0	4.0	3.5	399.6	8 / 48

6518-10C Pliers Wrench



Ratchet function allows quick and easy tighten or release bolts .



17 positions quick lock design with 42mm Max. jaws capacity .



Parallel jaws provide a more solid grip .

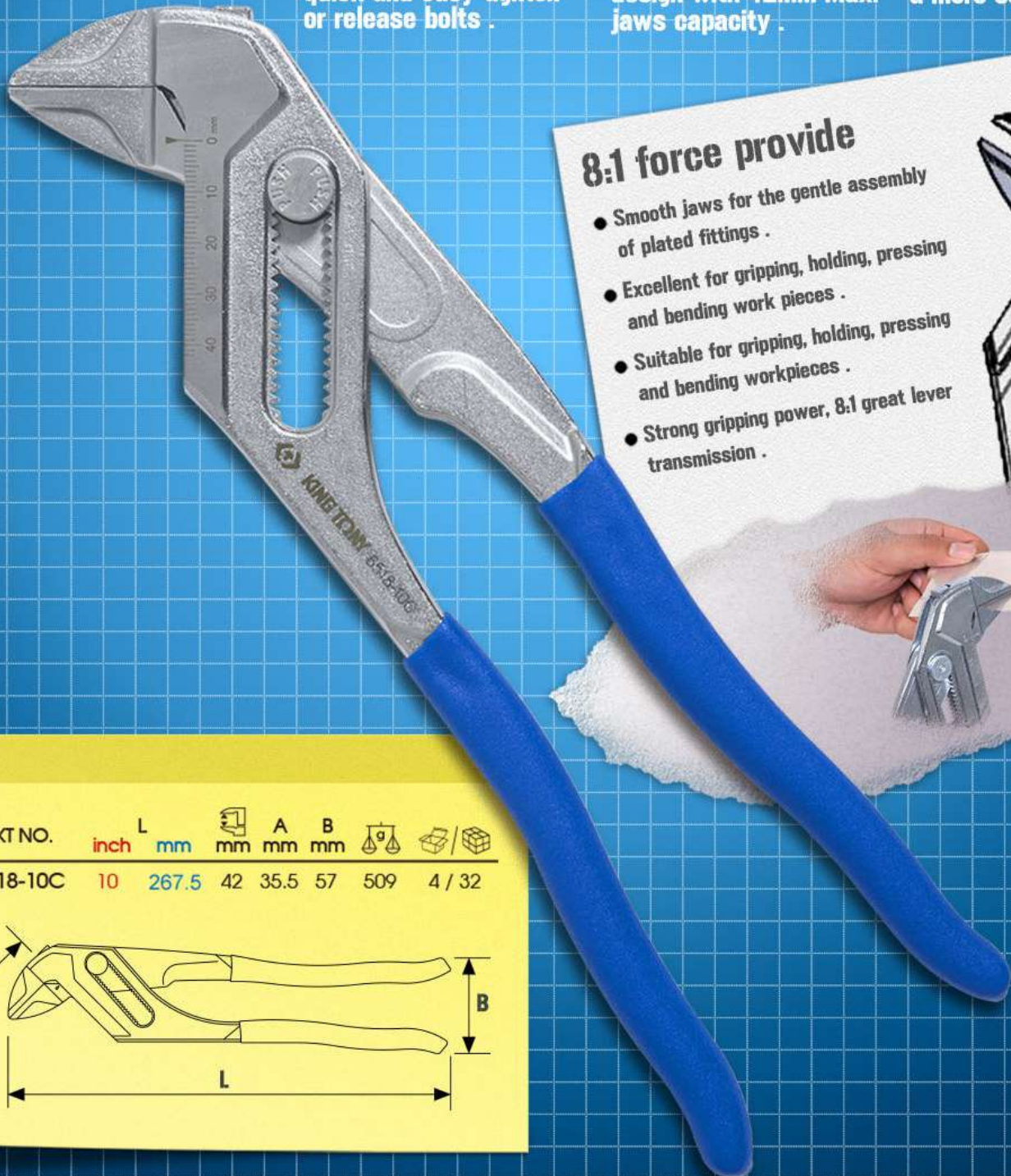

8:1 force provide

- Smooth jaws for the gentle assembly of plated fittings .
- Excellent for gripping, holding, pressing and bending work pieces .
- Suitable for gripping, holding, pressing and bending workpieces .
- Strong gripping power, 8:1 great lever transmission .



KT NO.	L inch	mm	A mm	B mm	Weight g	Box Qty
6518-10C	10	267.5	42	35.5	509	4 / 32

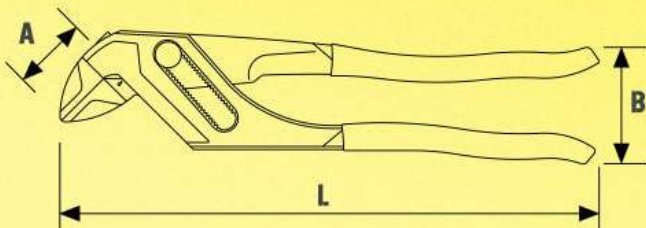

Circlip Pliers

• Grip material - PVC

66HS

66HB

66SS

66SB



- Design of hidden spring
- Straight and angled pattern
- High strength of tip
- DIN 5254, DIN 5256



KT NO.	Tips	Overall length		Ø-tips	Capacity Ø mm	g	/
		inch	mm				
66HS-07		7	188	1.8	19~60	176	8 / 48
66HB-07		7	175	1.8	19~60	176	8 / 48
66SS-07		7	188	1.8	19~60	195	8 / 48
66SB-07		7	175	1.8	19~60	195	8 / 48

67HS

67HB

67SS

67SB

68HS

68HB



68SS

68SB



- For internal retaining rings
- Straight and angled pattern
- DIN 5254, DIN 5256



Internal type

- For external retaining rings
- Straight and angled pattern
- DIN 5254, DIN 5256



External type

Japanese type

European type

Japanese type

European type

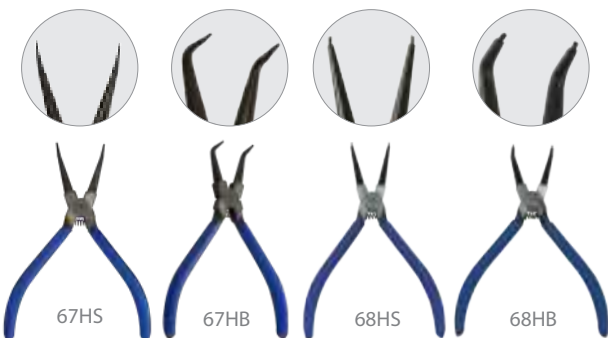

KT NO.	Tips	Overall length		Ø tips	Capacity Ø mm	g	/
		inch	mm				
67HS-07		7	180	1.8	19~60	129	12 / 144
67HB-07		7	180	1.8	19~60	131	12 / 144
68HS-05		5	125	1.3	12~28	83	10 / 80
68HS-07		7	180	1.8	19~60	134	12 / 144
68HS-10		10	250	2.3	40~100	322	8 / 64
68HB-05		5	125	1.3	12~28	94	10 / 80
68HB-07		6-3/4	170	1.8	19~60	131	12 / 144
68HB-10		9-1/2	241	2.3	40~100	317	6 / 48

KT NO.	Tips	Overall length		Ø tips	Capacity Ø mm	g	/
		inch	mm				
67SS-07		7	180	1.8	19~60	151	12 / 144
67SB-07		7	180	1.8	19~60	150	12 / 144
68SS-05		5	125	1.3	12~28	97	10 / 80
68SS-07		7	180	1.8	19~60	154	12 / 144
68SS-10		10	250	2.3	40~100	323	8 / 64
68SB-05		5	125	1.3	12~28	96	10 / 80
68SB-07		6-3/4	170	1.8	19~60	152	12 / 144
68SB-10		9-1/2	241	2.3	40~100	316	6 / 48



PLIERS

Circlip Pliers

- Grip material - PVC

65SS

- Design of hidden spring
- DIN 5254 & DIN 5256

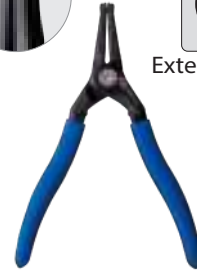

KT NO.	Overall length		Capacity Ø mm	g	kg
	inch	mm			
65SS-07	7	188	19~60	195	8 / 48

68HB-07L

- For removing or installing the intimal retaining rings
- 90 angel and extra long tip design for narrow space

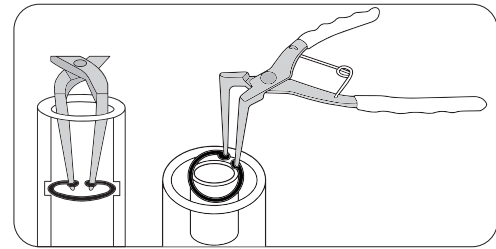
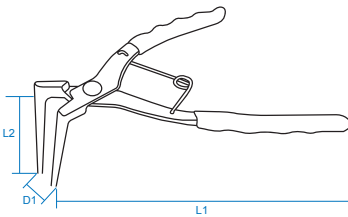

KT NO.	inch	L1	L2	D1	Ø	Capacity Ømm	g	kg
		mm	(mm)	(mm)	tips			
68HB-07L	7	180	56	23	1.3	19~60	222	12 / 48

Pliers Set



► Nylon pouch bag



► Color box

KT NO.	PC.	Contents				Package	kg	kg
42104GP	4					Nylon	1.17	1 / 18
42104GP01	4					Nylon	1.17	1 / 18
42124GP	4					Nylon	1.48	1 / 18
42124GP01	4					Nylon	1.48	1 / 18
42124GP04	4					Nylon	1.48	1 / 18
42213GP01	3					Color box	1.05	1 / 20

Circlip Pliers Set

KT NO.	PC.	Contents							
42114GP	4	 68HS-07	 68SS-07	 68HB-07	 68SB-07	062	1 / 32		
42154GP	4	 66HS-07	 66SB-07	 66HB-07	 66SS-07	0.84	1 / 32		
42116GP	6	 68HS-07	 68HB-07	 68HS-10	 68SS-07	 68SB-07	 68SS-10	1.33	1 / 18

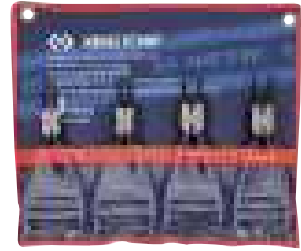

► Nylon pouch bag

• Finishing - option 1 : chrome plated (R) / option 2 : nickel plated (N)

Locking Pliers

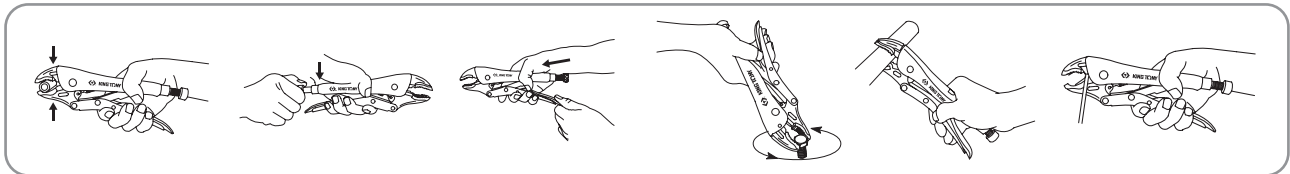

6011

- Locking pliers curved jaw straight tip with wire cutter
- With adjusting screw and release lever
- 2X more gripping power hold object tighter
- ASME B107.500-2010



MATERIAL - Jaw : Spring alloy steel
Handle : Chrome molybdenum alloy steel



6011R



6011

KT NO.	Overall length		Jaw capacity mm		
	inch	mm			
6011-05R	5-1/2	142	29	173	6 / 48
6011-07R	7	185	38	352	8 / 32
6011-07	7	185	38	351	8 / 32
6011-10R	10	254	48	542	8 / 32
6011-10	10	254	48	506	8 / 32

6012

- V jaw with wire cutter
- With adjusting screw and release lever
- ASME B107.500-2010



MATERIAL - Jaw : Chrome molybdenum alloy steel
Handle : Chrome molybdenum alloy steel



KT NO.	Overall length		Jaw capacity mm		
	inch	mm			
6012-07N	7	175	33	357	8 / 32
6012-10N	10	254	45	541	8 / 32

6013-10

- Large curved jaw
- 3X more gripping power hold object tighter
- Turn hexagon screw adjust pressure
- Quick trigger release lever
- ASME B107.500-2010



MATERIAL - Jaw : Chrome molybdenum alloy steel
Handle : Chrome molybdenum alloy steel



KT NO.	Overall length		Jaw capacity mm		
	inch	mm			
6013-10	10	254	50	550	8 / 32

6031

- Locking pliers straight jaw
- With adjusting screw and release lever
- ASME B107.500-2010



MATERIAL - Jaw : Spring alloy steel
Handle : Chrome molybdenum alloy steel



KT NO.	Overall length		Jaw capacity mm		
	inch	mm			
6031-07	7	185	33	371	8 / 32
6031-10	10	254	45	535	8 / 32

Long Nose Pliers

6315

- Locking pliers straight long nose with wire cutter
- ASME B107.500-2010

MATERIAL - Jaw : Spring alloy steel
Handle : Chrome molybdenum alloy steel

KT NO.	Overall length		Jaw capacity mm	Kg	Crate/Box
	inch	mm			
6315-06	6	166	51	186	8 / 80
6315-09	9	221	70	393	6 / 36



Locking Pliers Set

KT NO.	PC.	Contents		Kg	Crate/Box
42503PR	3	6011-10	6031-07	1.24	1 / 20
42504PR	4	6011-05	6315-06	1.43	1 / 15
		6013-10			



► Nylon pouch bag

Lock Sheet Metal Clamp

6605

- Locking pliers sheet metal bending and forming
- With adjusting screw and release lever
- Makes bending, forming, and crimping sheet metal easier

MATERIAL - Chrome molybdenum alloy steel



KT NO.	Overall length		Jaw capacity mm	Kg	Crate/Box
	inch	mm			
6605-08	8	206	13	475	1 / 18

Locking Welding Clamp

6665

- Locking pliers U jaw for odd shape welding
- U-shaped jaws allow enhanced visibility and more working space
- Holds work in proper alignment
- For use in welding or holding awkward shapes in place

MATERIAL - Chrome molybdenum alloy steel

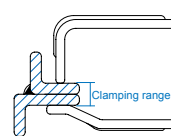

KT NO.	Overall length		Clamping range (W) mm	Kg	Crate/Box
	inch	mm			
6665-09	9	230	0-41	622	1 / 18

Locking Chain Clamp

6655

- Locking pliers chain grip for round shape
- Chain can hold around any shape or size
- Convenient for awkward shaped pieces
- With adjusting screw and release lever

MATERIAL - Handle : Chrome molybdenum alloy steel

KT NO.	Overall length		Capacity mm	Kg	Crate/Box
	inch	mm			
6655-09	9	225	∅ 60~140	733	1 / 18



PLIERS

C-clamp Grip Pliers

6615

- Locking pliers wide open C jaw with regular tips

MATERIAL -

Jaw : Chrome vanadium alloy steel

Handle : Chrome molybdenum alloy steel



KT NO.	Overall length		Capacity mm	Scales g	Boxes /
	inch	mm			
6615-06	6-3/4	170	50	247	6 / 72
6615-11	11	280	100	790	1 / 20
6615-18	18	456	200	1136	1 / 10

6625

- Locking pliers wide open C jaw with swivel pads

MATERIAL -

Jaw : Chrome vanadium alloy steel

Handle : Chrome molybdenum alloy steel



KT NO.	Overall length		Capacity mm	Scales g	Boxes /
	inch	mm			
6625-06	7	175	54	274	6 / 72
6625-11	11	280	96	840	1 / 20
6625-18	18-1/2	457	200	1220	1 / 10

Wire Twisting Pliers

6121

- Simple pull action twisting wires into a tight uniform fastener
- Material : Chrome vanadium alloy steel
- Twist wire up to 0.04 inch

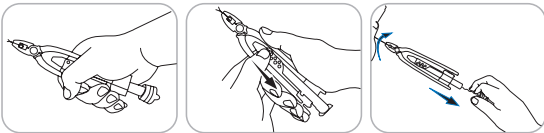
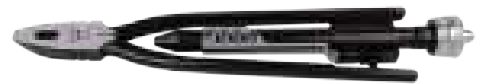

- Grip wire and pull down the bar
- Pull the lock
- Pull the knob



KT NO.	Twist wire mm	L	Scales g	Boxes /
6121-06X	Ø1.0	215	250	12 / 48
6121-09X	Ø1.5	262	380	12 / 48



PLIERS

PIPE TOOLS





Tube Cutter for Steel

7918-A0

- For steel pipes
- Strong cast housing
- Extra-long shank provides for quick & easy adjustment
- Possible for large pipe sizes
- Perfectly balanced



KT NO.	inch		mm		Overall length		g	boxes
				max. (mm)	inch	mm		
7918-A0	1-11/32	~3-9/16	43~114	3	28-1/8	900	5020	1 / 4
7918-A011	Spare cutting blade						66	1 / 200

Ratchet Tubing Cutter for Stainless Steel

7912-21

7912-22

- Cuts without having to rotate tool completely around tubing
- Ratchet mechanism allows for tight area operation
- Cuts through some of the toughest surfaces: stainless steel, wall conduit, copper and aluminum
- Exclusive one hand operation, limited risks of hand-fatigue and injuries

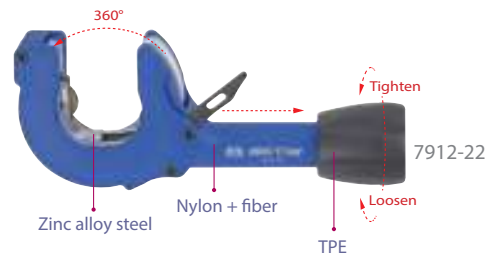

- Comes with spare blade.
- Provided with foldable reamer.

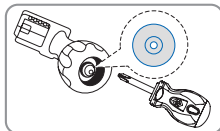

- Use Phillips screwdriver to take out the back-up blade located in the handle base.

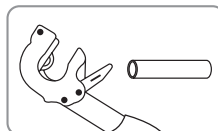

- Deploy foldable reamer provided to smoothen sharp edges. (only 7912-22)

KT NO.	Capacity ø mm	Max. cutting thickness (mm)		Remark	g	boxes
		Stainless	Other			
7912-21	8-28	2	3.0	spare blade	389	1 / 40
7912-22	12-35	2	3.0	spare blade / reamer	452	1 / 40
7912-0111	Spare cutting blade				5	25 / 250

7912-23

- Apply to cut car's exhaust pipe.

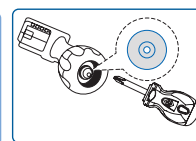
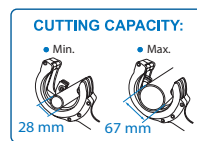
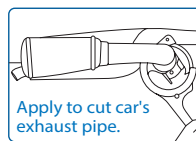

- Use Phillips screwdriver to take out the back-up blade located in the handle base.

KT NO.	Capacity ø mm	Max. cutting thickness (mm)		g	boxes	
		Stainless	Other			
7912-23	28-67	2	3.0	1122.6	1 / 10	
7912-2311	Spare cutting blade				5	25 / 250

Tube Cutter for Copper

7914A-35

- For copper, brass, aluminum pipes
- Ergonomic handle design for comfortable operation
- Includes one piece spare cutting wheel
- With four guide rollers
- Full-stop feed system prevents wheels and rollers from coming into contact
- Quick adjustment and easy to change the cutting wheel



KT NO.	inch		mm		max. (mm)		Overall length		g	boxes
							inch	mm		
7914A-35	1/8~1-3/8		3~35		1.2		5-1/2	140	333	10 / 60
7914A-0111					Spare cutting blade				13	25 / 250

7914C-70

- For copper, brass, aluminum pipes
- Ergonomic handle design for comfortable operation
- Includes one piece spare cutting wheel & retractable deburring tool
- With four guide rollers
- Full-stop feed system prevents wheels and rollers from coming into contact
- Quick adjustment and easy to change the cutting wheel



KT NO.	inch		mm		max. (mm)		Overall length		g	boxes
							inch	mm		
7914C-70	1/4~2-3/4		6~70		1.2		8-3/4	222	802	4 / 24
7914A-0111					Spare cutting blade				13	25 / 250
7914C-7021					Spare deburring tool				17	1 / 300

7915-30



KT NO.	inch		mm		max. (mm)		Overall length		g	boxes
							inch	mm		
7915-30	1/8~1-1/8		3~30		1.2		5-1/2	140	231	1 / 20
7915-3011					Spare cutting blade				10	25 / 250



Tube Cutter for Copper

7916M

- For copper pipes
- Easy to use in restricted space
- Self-alignment for adjustment

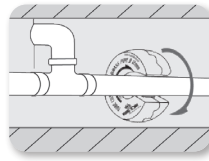

- Ideal for hard to reach places



KT NO.	mm	max. (mm)	Overall length mm	g	
7916-12M	12	1.2	52	176	10 / 100
7916-15M	15	1.2	56	207	10 / 100
7916-21M	21	1.2	68	248	10 / 60
7916-0111	Spare cutting blade			11	25 / 250

Mini Tube Cutter for Copper

- Full-stop feed system prevents wheels and rollers from coming into contact
- Ergonomic handle design for comfortable operation
- Quick adjustment and easy to change the cutting wheel
- For copper, brass, aluminum pipes
- Specifically design for using in restricted place
- With two guide rollers



7915A-19



7915A-28



KT NO.	inch	mm	max. (mm)	Overall length inch	Overall length mm	g	
7915A-19	1/8~3/4	3~19	1.2	2-1/2	62	152	10 / 100
7915A-28	1/8~1-1/8	3~28	1.2	2-3/4	70	205	10 / 100
7914A-0111	Spare cutting blade					13	25 / 250

Tube Cutter for PVC Soft Plastic Pipe

7913B-35

- For PVC, PP, PE, PEX, PB
- For soft plastic pipe
- Aluminum body
- One-hand operation
- Burr-free cutting
- Reversible blade



KT NO.	inch	mm	Overall length inch	Overall length mm	g	
7913B-35	1/8~1-3/8	3~35	8-1/4	211	215	20 / 60
7913B-3511	Spare cutting blade				36	1 / 100

Ratchet Tubing Cutter for PVC Pipe

7913

- For PVC, PP, PE, PEX, PB pipes
- Ratchet design for quick cutting



KT NO.	inch		mm		Overall length		g	boxes
					inch	mm		
7913-42	1/2~1-5/8	6~42	8	201	360	10 / 50		
7913-4211	Spare cutting blade				60	10 / 200		



2-in-1 Ratchet Tubing Cutter for PVC Pipe

7913A-63

- Easy one-hand operation
- Cut into thick pipe and thin pipe
- Easily apply for max. 63 O.D.
- Comfortable TPR handle
- For unitary material tube: PE, PP, PVDF, PB, PVC or similar tube
- Advanced tool steel blade and aluminum body
- Ratchet design for quick cutting



KT NO.	inch		mm		Overall length		g	boxes
					inch	mm		
7913A-63	1/4~2-1/2	6~63	11-1/2	293	802	6 / 24		
7913A-6311	Spare cutting blade				190	1 / 100		

S Type Pipe Wrench

6521

- For nuts, bolts, flat material
- A non-detachable adjusting nut with round thread ensures a wide adjustment
- For working in confined space
- DIN 5234

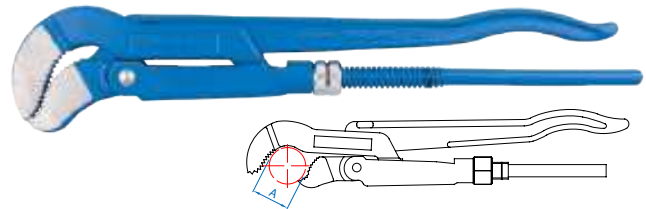

KT NO.	A mm	Size inch	Overall length		g	boxes
			inch	mm		
6521-13	40	1	13	330	791	1 / 20
6521-16	55	1-1/2	16-1/2	420	1450	1 / 12
6521-21	67	2	21	535	2404	1 / 6
6521-26	103	3	25-5/8	652	5030	1 / 2

Pipe Wrench

6531

- Professional stillson type
- High quality steel

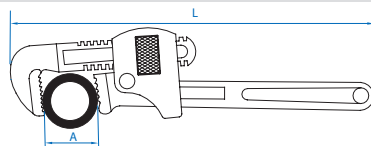



KT NO.	A		Overall length		g	boxes
	inch	mm	inch	mm		
6531-10	1-3/16	34	10	231	600	1 / 24
6531-12	1-9/16	42	12	271	780	1 / 24
6531-14	1-7/8	48	14	315	1050	1 / 12
6531-18	2-3/8	60	18	407	1720	1 / 12
6531-24	2-15/16	76	24	539	3150	1 / 6
6531-36	4	102	36	825	6280	1 / 2
6531-48	5-1/2	140	48	1034	9750	1 / 2

Pipe Wrench

6532

- Extra heavy straight type
- Forged parts tempered
- Teeth offset against direction of rotation and induction-hardened

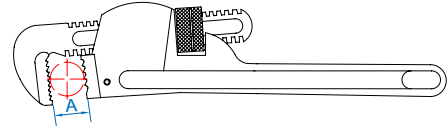

KT NO.	A mm	Overall length			
		inch	mm		
6532-08	27	8	180	380	1 / 40
6532-10	30	10	245	700	1 / 20
6532-12	40	12	275	1050	1 / 20
6532-14	50	14	315	1340	1 / 12
6532-18	60	18	395	1960	1 / 12
6532-24	75	24	525	3640	1 / 6
6532-36	85	36	765	6300	1 / 2
6532-48	110	48	1025	9100	1 / 2



Aluminum Pipe Wrench

6533L

- 25% lighter than heavy-duty models, easy to use
- Straight pipe wrench is suitable for all types of pipe work
- Drop-forged jaw is heat-treated to resist distortion
- Easy-spin adjusting nut, quick to adjust size

KT NO.	A mm	Overall length			
		inch	mm		
6533-10L	30	10	254	530	6 / 24
6533-12L	40	12	300	790	6 / 18
6533-14L	50	14	356	940	6 / 12
6533-18L	60	18	455	1480	3 / 6
6533-24L	75	24	600	2470	2 / 4
6533-36L	85	36	910	4670	1 / 2
6533-48L	110	48	1200	7960	1 / 2

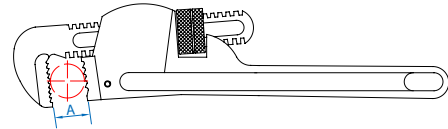

Flaring Tool Set

7CA0107M

- For producing precision flares on copper, brass, aluminium pipes up to 1 mm wall thickness
- Suitable for pipes in refrigeration, air conditioning

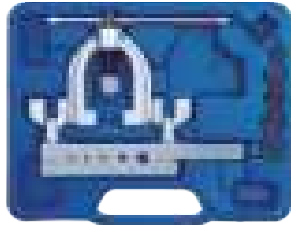
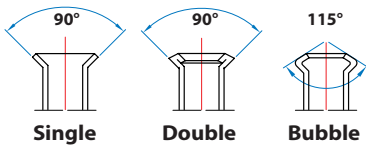

7 PC.

Contents 1.07 1 / 18

7CA22BP10M		4.75, 5, 6, 8, 10 mm
7CA22BP01		
Adapters for expander		4.75, 5, 6, 8, 10 mm

7CA0110S

- For producing precision flares on copper, brass, aluminium pipes up to 1 mm wall thickness
- Suitable for pipes in refrigeration, air conditioning

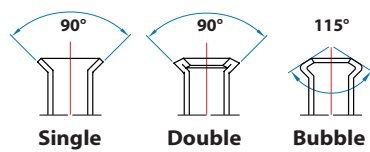

10 PC.

Contents 1.68 1 / 12

7915-30		3-30 mm 1/8~1-1/8"
7CA22P20S		3/16", 1/4", 5/16", 3/8", 7/16", 1/2", 5/8"
7CA22P01		
Adapter for expander		3/16", 1/4", 5/16", 3/8", 7/16", 1/2", 5/8"

Type of the flares

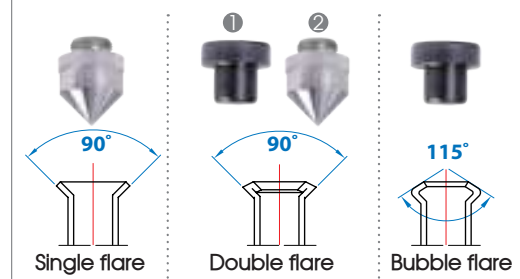

Ratchet Pipe Threader Set

7CA0606S

- Use to thread pipe for attach fitting and connector
- Thread sizes:
4pcs interchangeable dies 1/2", 3/4", 1" and 1-1/4"
- Ratchet threader assembly with extension handle



7CA0606S1



7
PC.

KT NO.	Thread Plug Gauge	Capacity	Contents		7.1		1/2	
7CA0606S	BSPT	1/2"	7CA61-A01	7CA61-A011				
		3/4"	7CA61-A02	7CA61-A021				
		1"	7CA61-A03	7CA61-A031				
		1-1/4"	7CA61-A04	7CA61-A041				
7CA0606S1	NPT	1/2"	7CA61-B01	7CA61-B011				
		3/4"	7CA61-B02	7CA61-B021				
		1"	7CA61-B03	7CA61-B031				
		1-1/4"	7CA61-B04	7CA61-B041				

180° Tube Bender

7CA11M

7CA11S

- Suitable for use in refrigeration and air-conditioning, oil supply, heating installations, floor heating
- Able to accurately bend soft copper pipes, brass pipes, aluminum pipes, and thin-walled iron pipes (walls less than 0.6 mm) up to 180°
- Bending with the bending radius display and measurement scale

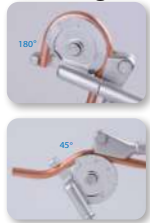

7CA11-12S
7CA11-16S



7CA11-15M / 7CA11-16M
7CA11-20S / 7CA11-24S

KT NO.	mm	max. (mm)	R(radius) inch	mm	Overall length inch	mm	2832	1 / 8
7CA11-15M	15	1.2	2-1/4	57	30	758	2832	1 / 8
7CA11-16M	16	1.2	2-1/4	57	30	758	2832	1 / 8

KT NO.	inch	max. (Inch)	R(radius) inch	mm	Overall length inch	mm	964	1 / 20
7CA11-12S	3/8	0.035	15/16	24	13	334	964	1 / 20
7CA11-16S	1/2	0.049	1-1/2	38	20	493	1833	1 / 12
7CA11-20S	5/8	0.049	2-1/4	57	30	758	2832	1 / 6
7CA11-24S	3/4	0.049	3	76	30	758	3500	1 / 6

90° Tube Bender

7CA15-10M

- 4 in 1 design, easy and quick to change the bend size
- Bend 5mm, 6mm, 8mm and 10mm outside diameter brass, copper or aluminum tubing
- Unique design allows bending in tight spaces
- Comfort grip handles reduce hand fatigue and slippage



KT NO.



3/16, 1/4, 5/16, 3/8



0.9

Overall length
inch mm

10-7/8 275



958



6 / 24

Stepped Ratchet Radiator Key Set

7HA03

- Suitable for installation and removal of most radiator valves and tank connectors
- Key has fittings from small to large, stepped along the length of the key, for different internal hexagon and internal lug valve sizes
- Stepped hexagon key with 3/8", 7/16", 1/2", 3/4", 1"
- 1/2"DR. ratchet makes installations quickly and easily
- 4724-11G can be used as general ratchet, DIN 3122, 11° gear action degree (32 teeth)

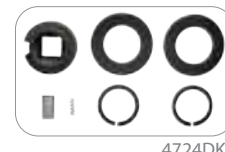
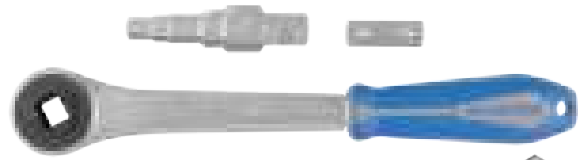

4724DK

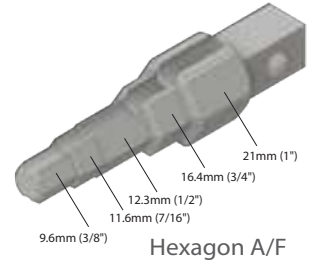

Hexagon A/F

Contents

0.74 kg / 1 / 24

4724-11G

7HA11

4724-01



4-way Control Cabinet Key

7HA21

- For all standard cabinets and shut-off systems
- For control cabinets and shut-off systems in the supply of gas, water and electricity
- For technical installations in buildings, e. g. air conditioning and ventilation systems, shut-off valves, mains switch-boards, etc.



• Outer ring : diameter 11.9 mm
• Inner ring : 6 x 6 mm



• Outer ring : diameter 14 mm
• Inner ring : 8 x 8 mm



• Outer ring : diameter 14 mm
• Inner ring : triangle height 9 mm



• Outer ring : 14 x 9 mm
• Inner ring : diameter 5.5 mm

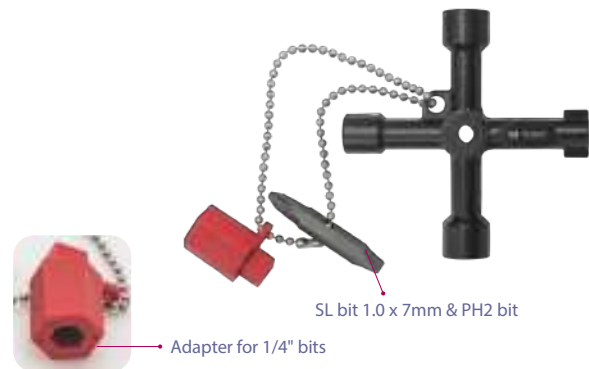

SL bit 1.0 x 7mm & PH2 bit

Adapter for 1/4" bits



KT NO.	mm	mm	mm	No.	mm	g	mm
7HA21	6, 8	9	3-5	PH2	1.0 x 7	89	20 / 200



PIPE TOOLS

SCREWDRIVERS & L-WRENCHES & BITS





Screwdriver

- Shank material - SNCM - V alloy steel
- Grip material - PP + TPR
- Finishing - chrome plated with black tip

1421



- Phillips head, round shank
- DIN ISO 8764

KT NO.	No.	mm		mm	g	mm	mm
		mm	inch				
14210023	PH0	60	2-3/8	3.2	35	12 / 144	
14210132	PH1	80	3-1/8	4.5	57	12 / 96	
14210104	PH1	100	4	4.5	59	12 / 96	
14210214	PH2	38	1-1/2	6.5	45	12 / 144	
14210204	PH2	100	4	6.0	84	12 / 96	
14210206	PH2	150	6	6.0	94	12 / 144	
14210306	PH3	150	6	8.0	142	12 / 144	



KT NO.	No.	mm		mm	g	mm	mm
		mm	inch				
14210112	PH1	300	12	4.5	85	12 / 96	
14210212	PH2	300	12	6.0	129	12 / 96	
14210116	PH1	400	16	4.5	97	12 / 96	
14210216	PH2	400	16	6.0	151	12 / 96	



1421xx12
1421xx16

1422



- Slotted head, round shank
- DIN ISO 2380

KT NO.	mm		mm	mm		mm	g	mm
	mm	inch		mm	inch			
14220303	3	1/8	0.5	75	3	3.2	38	12 / 144
14220404	4	5/32	0.8	100	4	4.0	56	12 / 96
14220503	5	3/16	0.8	75	3	5.0	59	12 / 96
14220504	5	3/16	0.8	100	4	5.0	63	12 / 96
14225503	5.5	7/32	1.0	75	3	5.0	71	12 / 96
14225504	5.5	7/32	1.0	100	4	5.0	75	12 / 96
14225505	5.5	7/32	1.0	125	5	5.0	79	12 / 144
14225506	5.5	7/32	1.0	150	6	5.0	83	12 / 144
14226514	6.5	1/4	1.2	38	1-1/2	6.5	46	12 / 144
14226504	6.5	1/4	1.2	100	4	6.0	83	12 / 96
14226506	6.5	1/4	1.2	150	6	6.0	95	12 / 144
14220806	8	5/16	1.2	150	6	8.0	141	12 / 144
14220807	8	5/16	1.2	175	7	8.0	153	12 / 144
14220808	8	5/16	1.2	200	8	8.0	163	12 / 144
14221008	10	3/8	1.6	200	8	10.0	214	12 / 72



KT NO.	mm		mm	mm		mm	g	mm
	mm	inch		mm	inch			
14220512	5	3/16	0.8	300	12	5.0	94	12 / 96
14220516	5	3/16	0.8	400	16	5.0	109	12 / 96
14226512	6.5	1/4	1.2	300	12	6.0	129	12 / 96
14226516	6.5	1/4	1.2	400	16	6.0	150	12 / 96



1422xx12
1422xx16



Screwdriver

KT No. & D1



- Shank material - SNCM - V alloy steel
- Grip material - PP + TPR
- Finishing - chrome plated with black tip

1423



- For torx head screw, round shank

14232010, 14232510, 14233010 at the dashboard, car body, engine compartment as well as in industry.



KT NO.	Size	mm		mm	g	kg	mm
		mm	inch				
14230602	T6	48	2	3.2	35	12 / 144	
14230702	T7	48	2	3.2	35	12 / 144	
14230803	T8	75	3	3.2	37	12 / 144	
14230903	T9	75	3	3.2	37	12 / 144	
14231003	T10	75	3	3.2	37	12 / 144	
14231503	T15	75	3	4.0	54	12 / 144	
14231510	T15	250	10	5.0	86	12 / 96	
14232004	T20	100	4	5.0	63	12 / 144	
14232010	T20	250	10	5.0	87	12 / 96	
14232504	T25	100	4	6.0	84	12 / 144	
14232510	T25	250	10	6.0	118	12 / 96	
14232704	T27	100	4	6.0	84	12 / 144	
14233005	T30	125	5	6.0	91	12 / 144	
14233010	T30	250	10	6.0	119	12 / 96	
14234006	T40	150	6	8.0	143	12 / 144	

1424



- Square head



KT NO.	Size	mm		mm	g	kg	mm
		mm	inch				
14240206	RB2	150	6	6.0	94	12 / 144	

1427



- For torx head screw, round shank
- Tamper-resistant type



KT NO.	Size	mm		mm	g	kg	mm
		mm	inch				
14270803	T8H	75	3	3.2	36	12 / 144	
14270903	T9H	75	3	3.2	36	12 / 144	
14271003	T10H	75	3	3.2	36	12 / 144	
14271503	T15H	75	3	4.0	54	12 / 144	
14272004	T20H	100	4	5.0	63	12 / 144	
14272504	T25H	100	4	6.0	84	12 / 144	
14272704	T27H	100	4	6.0	84	12 / 144	
14273005	T30H	125	5	6.0	89	12 / 144	
14274006	T40H	150	6	8.0	142	12 / 144	

1428



- Pozidriv head, round shank
- DIN ISO 8764









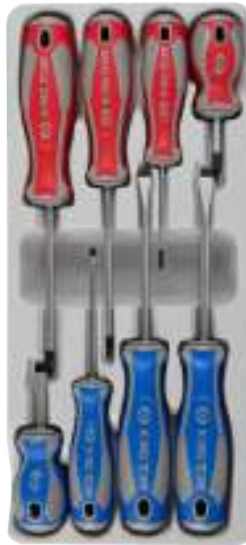

KT NO.	No.	mm		mm	g	kg	mm
		mm	inch				
14280023	PZ0	60	2-3/8	3.2	37	12 / 96	
14280132	PZ1	80	3-1/8	4.5	57	12 / 96	
14280104	PZ1	100	4	4.5	59	12 / 96	
14280204	PZ2	100	4	6.0	83	12 / 96	
14280306	PZ3	150	6	8.0	142	12 / 144	



Screwdriver Set

- Shank material - SNCM - V alloy steel
- Grip material - PP + TPR
- Finishing - chrome plated with black tip



KT NO.	PC.	Contents		
31107MR	7	 1421 PH0 x 60, PH1 x 80, PH1 x 100, PH2 x 38, PH2 x 100, PH2 x 150, PH3 x 150	0.70	1 / 20
30118MR	8	 1422 3 x 75, 5 x 75, 5 x 100, 8 x 150, 8 x 200, 6.5 x 100, 6.5 x 150, 6.5 x 38	0.90	1 / 20
30115MR	5	 1421 PH1 x 80, PH2 x 100	0.54	1 / 20
		 1422 4 x 100, 5.5 x 125, 6.5 x 150		
31116MR	6	 1421 PH0 x 60, PH1 x 80, PH2 x 100	0.56	1 / 20
		 1422 3 x 75, 5.5 x 100, 6.5 x 150		
31216MR	6	 1421 PH1 x 80, PH2 x 100	0.65	1 / 20
		 1422 5 x 75, 5 x 100, 6.5 x 100, 6.5 x 150		
30117MR	7	 1421 PH1 x 80, PH2 x 100	0.77	1 / 20
		 1422 3 x 75, 4 x 100, 5.5 x 125, 6.5 x 150, 8 x 175		
33108MR	8	 1421 PH0 x 60, PH1 x 100, PH2 x 100, PH2 x 38	1.30	1 / 10
		 1422 3 x 75, 5.5 x 100, 6.5 x 38, 6.5 x 100		
30127MR	7	 1428 PZ1 x 80, PZ2 x 100, PZ3 x 150	0.82	1 / 20
		 1422 4 x 100, 5.5 x 125, 6.5 x 150, 8 x 175		
30315PR	5	 1423 T15 x 75, T20 x 100, T25 x 100, T27 x 100, T30 x 125	0.37	1 / 20
30316PR	6	 1423 T10 x 75, T15 x 75, T20 x 100, T25 x 100, T30 x 125, T40 x 150	0.48	1 / 20
30317PR	7	 1423 T10 x 75, T15 x 75, T20 x 100, T25 x 100, T27 x 100, T30 x 125, T40 x 150	0.78	1 / 20
30319PR	9	 1423 T8 x 75, T9 x 75, T10 x 75, T15 x 75, T20 x 100, T25 x 100, T27 x 100, T30 x 125, T40 x 150	0.88	1 / 20
30307PR	7	 1427 T10H x 75, T15H x 75, T20H x 100, T25H x 100, T27H x 100, T30H x 125, T40H x 150	0.78	1 / 20
30309PR	9	 1427 T8H x 75, T9H x 75, T10H x 75, T15H x 75, T20H x 100, T25H x 100, T27H x 100, T30H x 125, T40H x 150	0.88	1 / 20

Screwdriver & Set

KT No. & D1



- Shank material - S2 alloy steel
- Grip material - PP + TPR
- Finishing - Magnet chrome plated with black tip

14A1



- Phillips head, round shank
- DIN ISO 8764

KT NO.	No.	mm	inch	mm	g	mm	mm
14A10132	PH1	80	3-1/8	5.0	60	12 / 96	
14A10214	PH2	38	1-1/2	6.0	45	12 / 144	
14A10204	PH2	100	4	6.0	88	12 / 96	
14A10306	PH3	150	6	8.0	144	12 / 144	



14A2



- Slotted head, round shank
- DIN ISO 2380

KT NO.	mm	inch	mm	mm	inch	mm	g	mm
14A20303	3	1/8	0.6	75	3	3.0	37	12 / 144
14A20404	4	5/32	0.8	100	4	4.0	56	12 / 96
14A25504	5.5	5/32	1.0	100	4	5.5	82	12 / 96
14A25505	5.5	7/32	1.0	125	5	5.5	86	12 / 144
14A26514	6.5	1/4	1.2	38	1-1/2	6.5	47	12 / 144
14A26506	6.5	1/4	1.2	150	6	6.5	105	12 / 144
14A20808	8	5/16	1.6	200	8	8.0	166	12 / 144



14A8



- Pozidriv head, round shank
- DIN ISO 8764

KT NO.	No.	mm	inch	mm	g	mm	mm
14A80132	PZ1	80	3-1/8	5.0	60	12 / 96	
14A80204	PZ2	100	4	6.0	89	12 / 96	



KT NO.	PC.	Contents	Kg	mm
30106AMRB	6	14A1 PH1 x 80, PH2 x 100	0.56	1 / 12
		14A2 3 x 75, 4 x 100, 5.5 x 125, 6.5 x 150		
30116AMRB	6	14A8 PZ1 x 80, PZ2 x 100	0.56	1 / 12
		14A2 3 x 75, 4 x 100, 5.5 x 125, 6.5 x 150		
30107AMRB	7	14A1 PH1 x 80, PH2 x 100, PH3 x 150	0.82	1 / 12
		14A2 3 x 75, 4 x 100, 5.5 x 125, 6.5 x 150		



Screwdriver & Set

- Shank material - Chrome vanadium alloy steel
- Grip material - PP
- Finishing - chrome plated

1411



- Phillips head, round shank
- DIN ISO 8764

KT NO.	No.	mm		mm	g	kg	/
		mm	inch				
14110003	PH0	75	3	3.0	28	12 / 240	
14110104	PH1	100	4	5.0	41	12 / 240	
14110214	PH2	38	1-1/2	6.5	30	12 / 144	
14110204	PH2	100	4	6.0	68	12 / 96	
14110204-E*	PH2	100	4	6.0	86	12 / 96	
14110205-E*	PH2	125	5	6.0	92	12 / 144	
14110206	PH2	150	6	6.0	80	12 / 144	
14110206-E*	PH2	150	6	6.0	96	12 / 144	
14110208-E*	PH2	200	8	6.0	108	12 / 144	
14110306	PH3	150	6	8.0	123	12 / 144	
14110308	PH3	200	8	8.0	146	12 / 144	

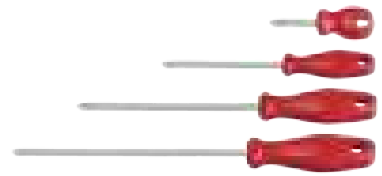

* Enlarged handle

1412



- Slotted head, round shank
- DIN ISO 2380

KT NO.	mm		mm	mm		mm	g	kg	/
	mm	inch		mm	inch				
14120303	3.0	1/8	0.5	75	3	3.0	27	12 / 240	
14120404	4.0	5/32	0.8	100	4	4.0	33	12 / 240	
14125504	5.5	7/32	0.8	100	4	5.0	40	12 / 240	
14126514	6.5	1/4	1.2	38	1-1/2	6.5	30	12 / 144	
14126504	6.5	1/4	1.2	100	4	6.0	71	12 / 96	
14126504-E*	6.5	1/4	1.2	100	4	6.0	86	12 / 96	
14126506	6.5	1/4	1.2	150	6	6.0	79	12 / 144	
14126506-E*	6.5	1/4	1.2	150	6	6.0	105	12 / 144	
14120806	8.0	5/16	1.2	150	6	8.0	126	12 / 144	
14120808	8.0	5/16	1.2	200	8	8.0	142	12 / 144	

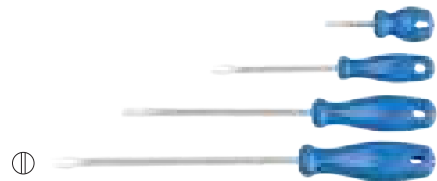

* Enlarged handle

2411



- Two-way screwdriver hex shank

KT NO.	No.	mm		mm		g	kg	/
		mm	inch	mm	inch			
24110204	PH2	7	1.2	100	4	89	20 / 240	
24110214	PH2	7	1.2	38	1-1/2	42	20 / 240	



KT NO.	PC.	Contents		kg	/
35105MR	5	1411	PH1 x 100, PH2 x 100	0.54	1 / 20
		1412	4 x 100, 5.5 x 100, 6.5 x 150		
35116MR01	6	1411	PH1 x 100, PH2 x 100, PH3 x 150	0.65	1 / 20
		1412	4 x 100, 5.5 x 100, 6.5 x 150		
35107MR	7	1411	PH1 x 100, PH2 x 100, PH3 x 150	0.72	1 / 20
		1412	4 x 100, 5.5 x 100, 6.5 x 150, 8 x 150		



- Magnet
- Chrome plated with black tip

- Color rubber handle
- Grip material - PP + TPR

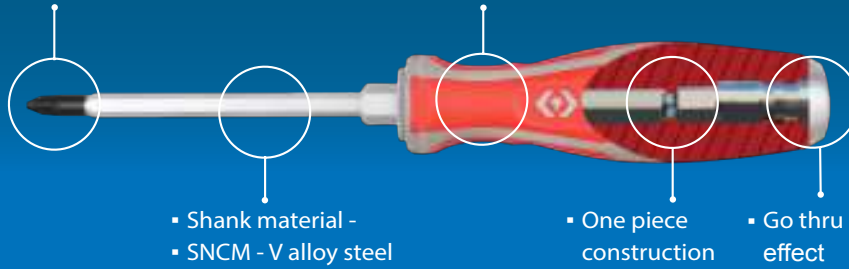

- Shank material -
- SNCM - V alloy steel

- One piece construction

- Go thru and cushioning effect

Go Thru Screwdriver & Set

KT No. & D1

- Shank material - SNCM - V alloy steel
- Grip material - PP + TPR
- Finishing - chrome plated with black tips

1461

- Phillips head, hex-shank
- DIN ISO 8764

KT NO.	No.	mm		mm	mm	g	/
		mm	inch				
14610103	PH1	75	3	5.0	10	121	12 / 96
14610204	PH2	100	4	6.0	10	135	12 / 96
14610206	PH2	150	6	6.0	10	148	12 / 144
14610306	PH3	150	6	8.0	13	219	12 / 96

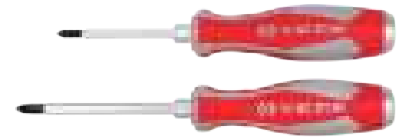

1462

- Slotted head, hex-shank
- DIN ISO 2380

KT NO.	mm		mm	mm		mm	mm	g	/
	mm	inch		mm	inch				
14625504	5.5	7/32	1.0	100	4	5.0	10	125	12 / 96
14626504	6.5	1/4	1.2	100	4	6.0	10	134	12 / 96
14626506	6.5	1/4	1.2	150	6	6.0	10	147	12 / 144
14620806	8.0	5/16	1.2	150	6	8.0	13	217	12 / 144
14620807	8.0	5/16	1.2	175	7	8.0	13	228	12 / 144
14621008	10.0	3/8	1.6	200	8	10.0	16	310	12 / 72
14621012	10.0	3/8	1.6	300	12	10.0	16	391	10 / 40
14621210	12.0	15/32	2.0	250	10	10.0	16	347	10 / 40



30206MR

Contents

1.20 Kg 1 / 20

⊕ 1461 PH1 x 75, PH2 x 100, PH3 x 150

⊖ 1462 5.5 x 100, 6.5 x 150, 8.0 x 175



6 PC.

35208MR

Blow case size (mm) :
430 x 300 x 50 (1.29 cuft)

Contents

2.16 Kg 1 / 4

⊕ 1461 PH1 x 75, PH2 x 100, PH3 x 150

⊖ 1462 6.5 x 100, 8.0 x 175, 10 x 300

⊕ 1421 PH2 x 38

⊖ 1422 6.5 x 38

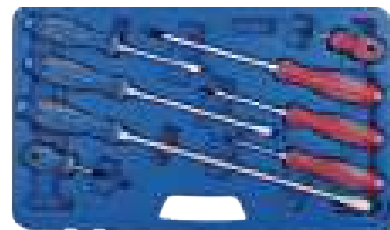

8 PC.

Go Thru Screwdriver & Set

- Shank material - S2 alloy steel
- Grip material - PP + TPR
- Finishing - Magnet chrome plated with black tip

14B1



- Phillips head, hex-shank
- DIN ISO 8764

KT NO.	No.	mm		inch		mm	g	No. / Box
		mm	inch	mm	inch			
14B10103	PH1	75	3	5.0	130	12 / 96		
14B10204	PH2	100	4	6.0	134	12 / 96		
14B10206	PH2	150	6	6.0	145	12 / 144		
14B10306	PH3	150	6	8.0	241	12 / 96		



14B2



- Slotted head, hex-shank
- DIN ISO 2380

KT NO.	mm		inch		mm	g	No. / Box	
	mm	inch	mm	inch				
14B25504	5.5	7/32	1.0	100	4	5.5	139	12 / 96
14B26506	6.5	1/4	1.2	150	6	6.5	164	12 / 144
14B20807	8.0	5/16	1.6	175	7	8.0	252	12 / 96



30206AMRB

Contents

1.20 1 / 12

14B1 PH1 x 75, PH2 x 100, PH3 x 150

14B2 5.5 x 100, 6.5 x 150, 8.0 x 175



6
PC.

Go Thru Screwdriver

- Shank material - Chrome vanadium alloy steel
- Grip material - PP
- Finishing - chrome plated

1481



- Phillips head, hex-shank
- DIN ISO 8764

KT NO.	No.	mm		inch		mm	g	No. / Box
		mm	inch	mm	inch			
14810103	PH1	75	3	5.0	55	12 / 240		
14810204	PH2	100	4	6.0	93	12 / 144		
14810204-E*	PH2	100	4	6.0	112	12 / 96		
14810205	PH2	125	5	6.0	99	12 / 144		
14810205-E*	PH2	125	5	6.0	118	12 / 144		
14810306	PH3	150	6	8.0	175	12 / 144		
14810412	PH4	300	12	10.0	328	10 / 40		



* Enlarged handle

Go Thru Screwdriver & Set

KT No. & D1



- Shank material - Chrome vanadium alloy steel
- Grip material - PP
- Finishing - chrome plated

1482



- Slotted head, hex-shank
- DIN ISO 2380

KT NO.	mm		inch		mm	mm	g	mm	mm
	mm	inch	mm	inch					
14825503	5.5	7/32	0.8	75	3	5.0	54	12 / 240	
14826504	6.5	1/4	1.2	100	4	6.0	93	12 / 144	
14826504-E*	6.5	1/4	1.2	100	4	6.0	112	12 / 96	
14826505-E*	6.5	1/4	1.2	125	5	6.0	116	12 / 144	
14826506	6.5	1/4	1.2	150	6	6.0	103	12 / 144	
14820806	8.0	5/16	1.2	150	6	8.0	174	12 / 144	
14821012	10.0	12/32	1.6	300	12	10.0	326	10 / 40	

* Enlarged handle



36206MR

Contents

0.97 kg 1 / 20

⊕ 1481 PH1 x 75, PH2 x 100, PH3 x 150

⊖ 1482 5.5 x 75, 6.5 x 150, 8.0 x 150

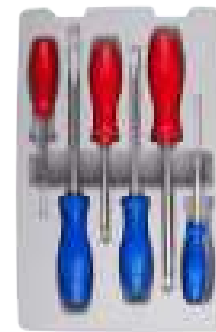

6 PC.

35114MR

- Standard & insulated & go thru screwdriver set

35114MR01



14 PC.



KT NO.	Contents		2.40 kg 1 / 4
35114MR	⊖ 1472 6.5 x 150	⊕ 1411 PH0 x 75, PH1 x 100, PH2 x 100, PH2 x 150, PH2 x 38, PH3 x 150	
35114MR01	⊕ 1478 PZ2 x 100	⊖ 1412 3 x 75, 4 x 100, 5.5 x 100, 6.5 x 150, 6.5 x 38, 8 x 200	
		⊖ 1482 10 x 300	



Screwdriver Set

31416MR

- Standard screwdriver set

KT NO.	Contents	Each Q'ty
31416MR	 1421 PH0 x 60, PH1 x 80, PH1 x 100, PH2 x 38, PH2 x 100, PH2 x 150, PH3 x 150	6
	 1422 3.0 x 75, 4.0 x 100, 5.5 x 75, 5.5 x 100, 5.5 x 125, 6.5 x 38, 6.5 x 100, 6.5 x 150, 8.0 x 150	





96
PC.

Screwdriver shelf size (mm) : 600 x 240 x 210

KT NO.	Kg	CUFT
87105	3.30	1.97
31416MR-D	6.20	0.71

31516MR

- Standard & go thru screwdriver set

KT NO.	Contents	Each Q'ty
31516MR	 1427 T8H x 75, T9H x 75, T10H x 75, T15H x 75, T20H x 100, T25H x 100, T27H x 100, T30H x 125, T40H x 150	6
	 1461 PH1 x 75, PH2 x 100, PH3 x 150	
	 1462 5.5 x 100, 6.5 x 100, 6.5 x 150, 8.0 x 175	





96
PC.

Screwdriver shelf size (mm) : 600 x 240 x 210

KT NO.	Kg	CUFT
87105	3.30	1.97
31516MR-D	10.10	0.71

31519MR

- Standard Screwdriver set

KT NO.	Contents	Each Q'ty
31519MR	 1411 PH0 x 75, PH1 x 100, PH2 x 100, PH2 x 100E*, PH2 x 150, PH2 x 150E*, PH2 x 38, PH3 x 150, PH3 x 200	6
	 1412 3.0 x 75, 4.0 x 100, 5.5 x 100, 6.5 x 100, 6.5 x 150, 6.5 x 100E*, 6.5 x 38, 8 x 150, 8 x 200, 6.5 x 150E*	



114
PC.

Screwdriver shelf size (mm) : 650 x 250 x 210

KT NO.	Kg	CUFT
87111	3.50	1.97
31519MR-D	10.34	0.71





* Enlarged handle



Screwdriver Set

31427MR

- Standard screwdriver set

KT NO.	Contents
31427MR	 1421 PH0 x 60, PH1 x 80 x2, PH1 x 100 x2, PH2 x 38 x2, PH2 x 100 x2, PH2 x 150 x2, PH3 x 150 x2
	 1422 3.0 x 75 x3, 4.0 x 100 x2, 5.5 x 100 x2, 5.5 x 125 x2, 5.5 x 150 x2, 6.5 x 38 x2, 6.5 x 100 x2, 6.5 x 150 x2
	 1423 T10 x 75, T15 x 75, T20 x 100, T25 x 100, T30 x 125
	 1427 T10H x 75, T15H x 75, T20H x 100, T25H x 100, T30H x 125



40 PC.

Screwdriver shelf size (mm) : 325 x 205 x 270

KT NO.	 Kg	CUFT
87104	1.40	0.30
31427MR-D	2.66	0.27

Screwdriver Display

87104

- Overall size -W 325 x D 205 x H 270 mm
- Weight - 1.4 Kg / Cuft - 0.3



Magnetizer / Demagnetizer

79B1-01

- Quickly magnetize / demagnetize screwdriver tips or screw bits
- Magnetize your screwdrivers to allow them to grab small screws
- Demagnetize your screwdrivers to safely work on sensitive electronics





• Magnetizer



• Demagnetizer



KT NO.	Size (mm)	 Kg	 / 
79B1-01	52 x 50 x 30	88.6	20 / 80



Interchangeable Handle

91232

KT NO.	mm		inch		g	1 / 24
	mm	inch	mm	inch		
91232	6.35	1/4	135	5-1/4	84	12 / 144



Power Bit

1317

- Bits for screwdriver handle 91232
- Material - SNCM - V alloy steel

KT NO.	Size		mm		inch		g	1 / 24
	mm	inch	mm	inch				
1317012PN	⊕ PH1	⊕ PH2	175	7	45	40 / 400		
1317012ZN	⊕ PZ2	⊕ PZ1	175	7	45	40 / 400		
1317046SN	⊖ 4.0	⊖ 6.0	175	7	43	40 / 400		
1317057SN	⊖ 5.0	⊖ 7.0	175	7	43	40 / 400		
1317115TN	⊙ T10	⊙ T15	175	7	42	40 / 400		
1317225TN	⊙ T20	⊙ T25	175	7	45	40 / 400		
1317340TN	⊙ T30	⊙ T40	175	7	45	40 / 400		
1317401PN	⊖ 4.0	⊕ PH1	175	7	43	40 / 400		
131744BHN	● B4	● H4	175	7	45	40 / 400		
1317501ZN	⊖ 5.0	⊕ PZ1	175	7	43	40 / 400		
131755BHN	● B5	● H5	175	7	45	40 / 400		
1317602PN	⊖ 6.0	⊕ PH2	175	7	43	40 / 400		
131766BHN	● B6	● H6	175	7	46	40 / 400		
1317702ZN	⊖ 7.0	⊕ PZ2	175	7	44	40 / 400		



Screwdriver Set

32518MR

- Two-way screwdriver set

Contents 0.70 1 / 24

1317012PN	⊕ PH1		⊕ PH2
1317012ZN	⊕ PZ2		⊕ PZ1
1317046SN	⊖ 4.0		⊖ 6.0
1317057SN	⊖ 5.0		⊖ 7.0
1317115TN	⊙ T10		⊙ T15
1317225TN	⊙ T20		⊙ T25
1317340TN	⊙ T30		⊙ T40
131744BHN	● B4		● H4
131755BHN	● B5		● H5
131766BHN	● B6		● H6
91232			

- Shank material - SNCM - V alloy steel
- Grip material - PP + TPR
- Shank finishing - chrome plated



11 PC.

Blow case size (mm) : 233 x 120 x 43 (0.04cuft)



Screwdriver Set

32518MR01

Two-way screwdriver set



11
PC.

Blow case size (mm) : 233 x 120 x 43 (0.04cuft)

Contents 0.76 1 / 20

1317115TN		T10		T15
1317225TN		T20		T25
1317340TN		T30		T40
1317401PN		4.0		PH1
131744BHN		B4		H4
1317501ZN		5.0		PZ1
131755BHN		B5		H5
1317602PN		6.0		PH2
131766BHN		B6		H6
1317702ZN		7.0		PZ2
91232				

32518MR02

Two-way screwdriver set



11
PC.

Blow case size (mm) : 233 x 120 x 43 (0.04cuft)

Contents 0.70 1 / 24

1317115TN		T10		T15
1317225TN		T20		T25
1317340TN		T30		T40
1317401PN		4.0		PH1
131744BHN		B4		H4
1317012PN		PH1		PH2
131755BHN		B5		H5
1317602PN		6.0		PH2
131766BHN		B6		H6
1317057SN		5.0		7.0
91232				

Nut Spinner

1450

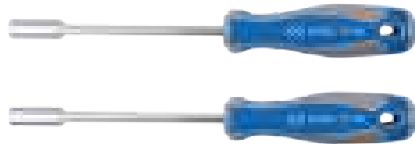

5450

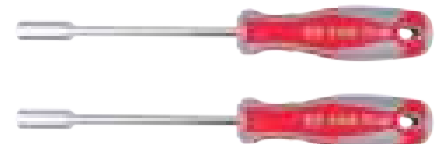

- Shank material - chrome vanadium alloy steel
- Grip material - PP + TPR
- Finishing - chrome plated

KT NO.	mm	mm	mm	mm	g	1 / 144
1450-04	4.0	4.5	125	225	74	12 / 144
1450-45	4.5	4.5	125	225	75	12 / 144
1450-05	5.0	5.0	125	225	75	12 / 144
1450-55	5.5	5.0	125	225	82	12 / 144
1450-06	6.0	6.0	125	225	81	12 / 144
1450-07	7.0	6.0	125	235	103	12 / 144
1450-08	8.0	7.0	125	235	108	12 / 144
1450-09	9.0	7.0	125	235	110	12 / 144
1450-10	10.0	8.0	125	235	114	12 / 144
1450-11	11.0	9.0	125	245	165	12 / 144
1450-12	12.0	10.0	125	245	169	12 / 144
1450-13	13.0	10.0	125	245	172	10 / 120

KT NO.	inch	mm	mm	mm	g	1 / 144
5450-08	1/4	12.0	125	223	81	12 / 144
5450-10	5/16	8.2	125	223	109	12 / 144

Flexible Nut Spinner

1453

For the hose clamps on radiator hoses

KT NO.	mm	mm	mm	mm	g	1 / 144
1453-05	5	14.3	190	300	132	12 / 144
1453-06	6	14.1	190	300	132	12 / 144
1453-07	7	14.5	190	300	137	12 / 144
1453-08	8	13.2	190	300	133	12 / 144
1453-10	10	12.7	190	300	135	12 / 144



Bit

- Silicon chrome vanadium alloy steel (S2)
- Anti-rust oiled, sand-blasted
- Total length : 25 mm

Item No. xxxxxxx.B



order unit : one box

1025P

- DIN ISO 2351-2



KT NO.	⊕ No.	g	📦 / 📦
102500P (102500P.B)	PH0	5	20 / 300 (50 / 1000)
102501P (102501P.B)	PH1	5	
102502P (102502P.B)	PH2	6	
102503P (102503P.B)	PH3	6	
102504P (102504P.B)	PH4	6	

1/4" Hex size shank driver

1025T

- For torx head screw



KT NO.	Size	g	📦 / 📦
102506T (102506T.B)	T6	5	20 / 300 (50 / 1000)
102507T (102507T.B)	T7	5	
102508T (102508T.B)	T8	5	
102509T (102509T.B)	T9	5	
102510T (102510T.B)	T10	5	
102515T (102515T.B)	T15	5	
102520T (102520T.B)	T20	5	
102525T (102525T.B)	T25	5	
102527T (102527T.B)	T27	5	
102530T (102530T.B)	T30	5	
102535T (102535T.B)	T35	6	
102540T (102540T.B)	T40	6	
102545T (102545T.B)	T45	7	
102550T (102550T.B)	T50	8	

102512P

- Reduced for dry-wall
- DIN ISO 2351-2



KT NO.	⊕ No.	g	📦 / 📦
102512P (102512P.B)	PH2	6	20 / 300 (50 / 1000)

1025S

- DIN ISO 2351-1



KT NO.	Tip width (mm)	Tip thickness (mm)	g	📦 / 📦
102503S1 (102503S1.B)	3.0	0.5	5	20 / 300 (50 / 1000)
102535S1 (102535S1.B)	3.5	0.6	5	
102504S1 (102504S1.B)	4.0	0.5	5	
102504S2 (102504S2.B)	4.0	0.8	5	
102545S1 (102545S1.B)	4.5	0.6	5	
102505S1 (102505S1.B)	5.0	0.8	5	
102555S1 (102555S1.B)	5.5	0.8	5	
102555S2 (102555S2.B)	5.5	1.0	5	
102506S1 (102506S1.B)	6.0	1.0	5	
102565S1 (102565S1.B)	6.5	1.2	6	
102507S1 (102507S1.B)	7.0	1.2	6	
102508S1 (102508S1.B)	8.0	1.2	6	
102508S2 (102508S2.B)	8.0	1.6	6	

1025U

- For torx head screw
- Tamper-resistant type



KT NO.	Size	g	📦 / 📦
102507U (102507U.B)	T7H	4	20 / 300 (50 / 1000)
102508U (102508U.B)	T8H	5	
102509U (102509U.B)	T9H	5	
102510U (102510U.B)	T10H	5	
102515U (102515U.B)	T15H	5	
102520U (102520U.B)	T20H	5	
102525U (102525U.B)	T25H	5	
102527U (102527U.B)	T27H	5	
102530U (102530U.B)	T30H	6	
102540U (102540U.B)	T40H	6	

1025H

- DIN ISO 2351-3



KT NO.	mm	g	📦 / 📦
102515H (102515H.B)	H1.5	4	20 / 300 (50 / 1000)
102502H (102502H.B)	H2	5	
102525H (102525H.B)	H2.5	5	
102503H (102503H.B)	H3	5	
102504H (102504H.B)	H4	6	
102505H (102505H.B)	H5	6	
102506H (102506H.B)	H6	6	
102507H (102507H.B)	H7	8	
102508H (102508H.B)	H8	9	
102510H (102510H.B)	H10	12	

5025H

KT NO.	inch	g	📦 / 📦
502503H (502503H.B)	3/64	4	20 / 300 (50 / 1000)
502504H (502504H.B)	1/16	4	
502505H (502505H.B)	5/64	5	
502506H (502506H.B)	3/32	5	
502507H (502507H.B)	7/64	5	
502508H (502508H.B)	1/8	5	
502509H (502509H.B)	9/64	5	
502510H (502510H.B)	5/32	5	

1025M

- DIN 65254



KT NO.	size	g	📦 / 📦
102504M	M4	5	20 / 300
102505M	M5	5	
102506M	M6	6	
102508M	M8	7	
102510M	M10	10	

1025V

- For inside 5-star screw
- Tamper-resistant type



KT NO.	Size	g	📦 / 📦
102508V	IPR 8	5	20 / 300
102509V	IPR 9	5	
102510V	IPR 10	5	
102515V	IPR 15	5	
102520V	IPR 20	5	
102525V	IPR 25	5	
102527V	IPR 27	5	
102530V	IPR 30	5	
102540V	IPR 40	6	



Bit

- Silicon chrome vanadium alloy steel (S2)
- Anti-rust oiled, sand-blasted

1/4" Hex size shank driver



order unit : one blister card



Item No.xxxxxxx.B

5/16" Hex size shank driver



order unit : one box

1025Z



- Pozidriv type
- DIN ISO 2351-2



KT NO.	No.	g	kg	kg
102501Z (102501Z.B)	PZ1	5		
102502Z (102502Z.B)	PZ2	6	20 / 300	
102503Z (102503Z.B)	PZ3	6	(50 / 1000)	

1025R



KT NO.	Size	g	kg	kg
102500R (102500R.B)	RB0	5		
102501R (102501R.B)	RB1	5	20 / 300	
102502R (102502R.B)	RB2	6	(50 / 1000)	
102503R (102503R.B)	RB3	6		

1360Z



KT NO.	No.	Overall length (mm)	g	kg
1360023Z	PZ2 / PZ3	60	14	10 / 150

1360Z



KT NO.	No.	Tip width (mm)	Tip thickness (mm)	Overall length (mm)	g	kg
1360451Z	PZ1	4.5	0.6	60	13	10 / 150
1360552Z	PZ2	5.5	1.0	60	14	10 / 150

1360P



KT NO.	No.	Overall length (mm)	g	kg
1360012P	PH1 / PH2	60	13	
1360022P	PH2 / PH2	60	14	10 / 150
1360023P	PH2 / PH3	60	14	

1360P



KT NO.	No.	Tip width (mm)	Tip thickness (mm)	Overall length (mm)	g	kg
1360552P	PH2	5.5	0.8	60	14	
1360703P	PH3	7.0	1.2	60	14	

1800P



- 36 / 80 / 125mmL
- DIN ISO 2251-2



KT NO.	No.	Overall length (mm)	g	kg
183601P	PH1	36	12	20 / 200
183602P	PH2	36	12	20 / 200
183603P	PH3	36	12	20 / 200
183604P	PH4	36	12	20 / 200
188002P	PH2	80	31	10 / 100
188003P	PH3	80	31	10 / 100
188004P	PH4	80	31	10 / 100
181202P	PH2	125	50	10 / 100
181203P	PH3	125	50	10 / 100

1800S



- 36 / 80mmL
- DIN ISO 2351-1



KT NO.	Tip width (mm)	Tip thickness (mm)	Overall length (mm)	g	kg
183608S	8	1.2	36	12	20 / 300
183609S	9	1.6	36	13	20 / 300
183610S	10	1.6	36	15	20 / 240
183611S	11	2.0	36	16	20 / 240
183612S	12	2.0	36	18	12 / 120
183614S	14	2.5	36	21	12 / 120
188008S	8	1.2	80	32	10 / 150
188010S	10	1.6	80	33	10 / 120
188012S	12	2.0	80	34	6 / 60

1800H



- 32 / 36 mmL



KT NO.	mm	Overall length (mm)	g	kg
183203H	H3	32	9	20 / 300
183204H	H4	32	10	20 / 300
183205H	H5	32	10	20 / 300
183206H	H6	32	11	20 / 300
183207H	H7	32	12	20 / 300
183208H	H8	32	13	20 / 300
183210H	H10	32	17	20 / 240
183212H	H12	32	22	12 / 120
183604H	H4	36	11	20 / 300
183605H	H5	36	12	20 / 300
183606H	H6	36	13	20 / 300
183607H	H7	36	14	20 / 300
183608H	H8	36	15	20 / 300
183610H	H10	36	19	20 / 240
183612H	H12	36	25	12 / 120
183614H	H14	36	31	12 / 120



Bit

- Silicon chrome vanadium alloy steel (S2)
- Anti-rust oiled, sand-blasted

5/16" Hex size shank driver



order unit: one box

1800T



- For torx internal screws
32 / 36 / 70 mmL



KT NO.	Size	Overall length (mm)	g	Box / Carton
183215T	T15	32	10	20 / 300
183220T	T20	32	10	20 / 300
183225T	T25	32	10	20 / 300
183227T	T27	32	11	20 / 300
183230T	T30	32	11	20 / 300
183240T	T40	32	11	20 / 300
183245T	T45	32	11	20 / 300
183250T	T50	32	11	20 / 300
183620T	T20	36	11	20 / 300
183625T	T25	36	11	20 / 300
183627T	T27	36	11	20 / 300
183630T	T30	36	12	20 / 300
183635T	T35	36	12	20 / 300
183640T	T40	36	13	20 / 300
183645T	T45	36	13	20 / 300
183650T	T50	36	14	20 / 300
183655T	T55	36	19	20 / 240
183660T	T60	36	22	20 / 120
187015T	T15	70	22	10 / 150
187020T	T20	70	22	10 / 150
187025T	T25	70	22	10 / 150
187027T	T27	70	22	10 / 150
187030T	T30	70	22	10 / 150
187040T	T40	70	22	10 / 150
187045T	T45	70	22	10 / 150
187050T	T50	70	22	10 / 150

1836Z



- 36 mmL



KT NO.	No.	Overall length (mm)	g	Box / Carton
183602Z	PZ2	36	12	20 / 300
183603Z	PZ3	36	12	20 / 300
183604Z	PZ4	36	13	20 / 300

10mm Hex size shank driver



order unit: one blister card

1600H



- 36 / 80mmL



1680xxH

KT NO.	mm	Overall length (mm)	g	Box / Carton
163604H	H4	36	17	12 / 144
163605H	H5	36	19	12 / 144
163606H	H6	36	19	12 / 144
163607H	H7	36	20	12 / 144
163608H	H8	36	21	12 / 144
163609H	H9	36	23	12 / 144
163610H	H10	36	24	12 / 144
163612H	H12	36	31	12 / 120
168004H	H4	80	47	6 / 72
168005H	H5	80	48	6 / 72
168006H	H6	80	49	6 / 72
168007H	H7	80	50	6 / 72
168008H	H8	80	51	6 / 72
168009H	H9	80	52	6 / 72
168010H	H10	80	54	6 / 72
168012H	H12	80	73	6 / 60

1600T



- For torx head screw
36 / 80mmL



1680xxT

KT NO.	Size	Overall length (mm)	g	Box / Carton
163610T	T10	36	17	12 / 144
163615T	T15	36	17	12 / 144
163620T	T20	36	18	12 / 144
163625T	T25	36	18	12 / 144
163627T	T27	36	18	12 / 144
163630T	T30	36	18	12 / 144
163640T	T40	36	20	12 / 144
163645T	T45	36	21	12 / 144
163650T	T50	36	23	12 / 144
163655T	T55	36	28	12 / 144
163660T	T60	36	33	12 / 120
168010T	T10	80	46	6 / 72
168015T	T15	80	47	6 / 72
168020T	T20	80	47	6 / 72
168025T	T25	80	47	6 / 72
168027T	T27	80	47	6 / 72
168030T	T30	80	47	6 / 72
168040T	T40	80	48	6 / 72
168045T	T45	80	49	6 / 72
168050T	T50	80	50	6 / 72
168055T	T55	80	52	6 / 72
168060T	T60	80	70	6 / 60



Bit

- Silicon chrome vanadium alloy steel (S2)
- Anti-rust oiled, sand-blasted

10mm Hex size shank driver



order unit : one blister card

1600E



- For torx Plus head screw
- 36 / 80mmL

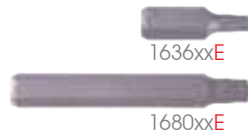

KT NO.	Size	Overall length (mm)	g	Box / Tray
163610E	IP10	36	15	12 / 144
163615E	IP15	36	16	12 / 144
163620E	IP20	36	16	12 / 144
163625E	IP25	36	16	12 / 144
163627E	IP27	36	17	12 / 144
163630E	IP30	36	17	12 / 144
163640E	IP40	36	18	12 / 144
163645E	IP45	36	20	12 / 144
163650E	IP50	36	21	12 / 144
163655E	IP55	36	25	12 / 144
163660E	IP60	36	31	12 / 120
168010E	IP10	80	45	6 / 72
168015E	IP15	80	45	6 / 72
168020E	IP20	80	45	6 / 72
168025E	IP25	80	46	6 / 72
168027E	IP27	80	46	6 / 72
168030E	IP30	80	47	6 / 72
168040E	IP40	80	48	6 / 72
168045E	IP45	80	49	6 / 72
168050E	IP50	80	50	6 / 72
168055E	IP55	80	60	6 / 72
168060E	IP60	80	79	6 / 60

1600U



- For torx head screw
- Tamper-resistant type
- 36 / 80mmL

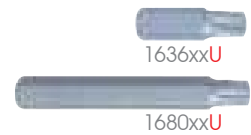

KT NO.	Size	Overall length (mm)	g	Box / Tray
163610U	T10H	36	17	12 / 144
163615U	T15H	36	17	12 / 144
163620U	T20H	36	18	12 / 144
163625U	T25H	36	18	12 / 144
163627U	T27H	36	18	12 / 144
163630U	T30H	36	18	12 / 144
163640U	T40H	36	20	12 / 144
163645U	T45H	36	21	12 / 144
163650U	T50H	36	23	12 / 144
163655U	T55H	36	28	12 / 144
163660U	T60H	36	33	12 / 120
168010U	T10H	80	46	6 / 72
168015U	T15H	80	47	6 / 72
168020U	T20H	80	47	6 / 72
168025U	T25H	80	47	6 / 72
168027U	T27H	80	47	6 / 72
168030U	T30H	80	47	6 / 72
168040U	T40H	80	48	6 / 72
168045U	T45H	80	49	6 / 72
168050U	T50H	80	50	6 / 72
168055U	T55H	80	52	6 / 72
168060U	T60H	80	70	6 / 60

1600M



- 36 / 80mmL

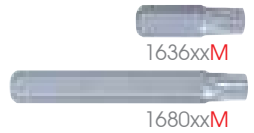

KT NO.	Size	Overall length (mm)	g	Box / Tray
163605M	M5	36	18	12 / 144
163606M	M6	36	19	12 / 144
163608M	M8	36	20	12 / 144
163609M	M9	36	21	12 / 144
163610M	M10	36	22	12 / 144
163612M	M12	36	28	12 / 120
163614M	M14	36	30	12 / 120
168005M	M5	80	47	6 / 72
168006M	M6	80	48	6 / 72
168008M	M8	80	49	6 / 72
168009M	M9	80	51	6 / 72
168010M	M10	80	52	6 / 72
168012M	M12	80	70	6 / 60
168014M	M14	80	71	6 / 60



Bit Set

- Silicon chrome vanadium alloy steel (S2)
- Anti-rust oiled, sand-blasted

1011MQ

Metal case size (mm) : 198 x 105 x 37 (0.027 cuft)



11 PC.

Contents

0.82 kg 1 / 20

●	1636M	M5, M6, M8, M10, M12
●	1680M	M5, M6, M8, M10, M12
○	414810M	

1015MQ

Metal case size (mm) : 198 x 105 x 37 (0.027 cuft)



15 PC.

Contents

0.96 kg 1 / 20

●	1636H	H4, H5, H6, H7, H8, H10, H12
●	1680H	H4, H5, H6, H7, H8, H10, H12
○	414810M	

1015PQ

Metal case size (mm) : 198 x 105 x 37 (0.027 cuft)



15 PC.

Contents

0.90 kg 1 / 20

⊛	1636T	T20, T25, T30, T40, T45, T50, T55
⊛	1680T	T20, T25, T30, T40, T45, T50, T55
○	414810M	

1023EQ

Metal case size (mm) : 244 x 118 x 37 (0.038 cuft)

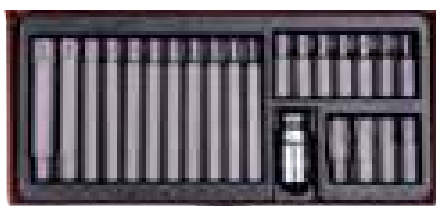

23 PC.

Contents

1.60 kg 1 / 18

⊛	1636E	10IP, 15IP, 20IP, 25IP, 27IP, 30IP, 40IP, 45IP, 50IP, 55IP, 60IP
⊛	1680E	10IP, 15IP, 20IP, 25IP, 27IP, 30IP, 40IP, 45IP, 50IP, 55IP, 60IP
○	414810M	

1040CQ

Metal case size (mm) : 320 x 153 x 31 (0.054 cuft)



40 PC.

Contents

2.0 kg 1 / 10

●	1630M	M5, M6, M8, M10, M12
●	1630H	H4, H5, H6, H7, H8, H10, H12
⊛	1630T	T20, T25, T30, T40, T45, T50, T55
●	1675M	M5, M6, M8, M10, M12
●	1675H	H4, H5, H6, H7, H8, H10, H12
⊛	1675T	T20, T25, T30, T40, T45, T50, T55
○	314810M, 414810M	

1042CQ

Metal case size (mm) : 205 x 80 x 42 (0.024 cuft)



42 PC.

Contents

0.52 kg 1 / 20

●	1025H	H1.5, H2, H2.5, H3, H4, H5, H6, H7, H8, H10
⊛	1025T	T6
⊛	1025U	T7H, T8H, T9H, T10H, T15H, T20H, T25H, T27H, T30H, T40H
⊖	1025S	3 x 0.5, 3.5 x 0.6, 4 x 0.5, 4.5 x 0.6, 5 x 0.8, 5.5 x 0.8, 6 x 1.0, 6.5 x 1.2, 7 x 1.2, 8 x 1.2
⊕	1025P	PH0, PH1, PH2, PH3
⊛	1025Z	PZ1, PZ2, PZ3
⊛	1025R	RB0, RB1, RB2, RB3

1043CQ

Metal case size (mm) : 290 x 130 x 41 (0.056 cuft)

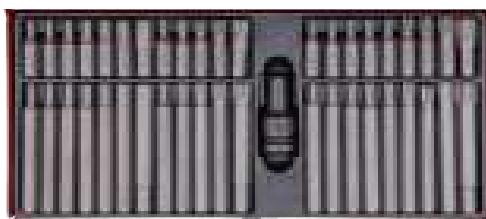

43 PC.

Contents

2.50 kg 1 / 10

●	1636H	H4, H5, H6, H7, H8, H10, H12
●	1636M	M5, M6, M8, M10, M12
⊛	1636T	T20, T25, T27, T30, T40, T45, T50, T55, T60
●	1680H	H4, H5, H6, H7, H8, H10, H12
●	1680M	M5, M6, M8, M10, M12
⊛	1680T	T20, T25, T27, T30, T40, T45, T50, T55, T60
⊛	414710M	



Bit Set

- Silicon chrome vanadium alloy steel (S2)
- Anti-rust oiled, sand-blasted

1044CQ

Metal case size (mm) : 296 x 130 x 41 (0.056 cuft)

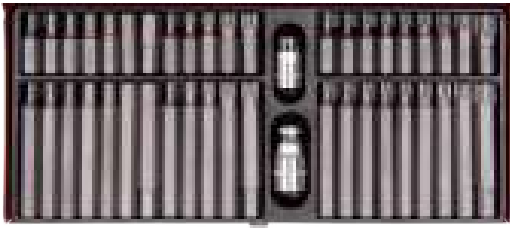

44 PC.

Contents 2.5 1 / 10

	1636H	H4, H5, H6, H7, H8, H10, H12
	1636M	M5, M6, M8, M10, M12
	1636T	T20, T25, T27, T30, T40, T45, T50, T55, T60
	1680H	H4, H5, H6, H7, H8, H10, H12
	1680M	M5, M6, M8, M10, M12
	1680T	T20, T25, T27, T30, T40, T45, T50, T55, T60
	314810M, 414810M	

5169PR

Metal case size (mm) : 445 x 187 x 50 (0.147 cuft)

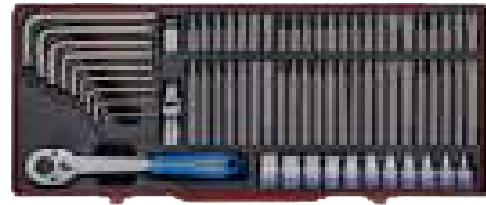

69 PC.

Contents 4.15 1 / 4

	3375M	E4, E5, E6, E7, E8, E10, E11, E12, E14, E16, E18
	1147R	T10H, T15H, T20H, T25H, T27H, T30H, T40H, T45H, T50H
	1636H	H4, H5, H6, H7, H8, H10, H12
	1636M	M5, M6, M8, M10, M12
	1636T	T10, T15, T20, T25, T27, T30, T40, T45, T50, T55, T60
	1680H	H4, H5, H6, H7, H8, H10, H12
	1680M	M5, M6, M8, M10, M12
	1680T	T10, T15, T20, T25, T27, T30, T40, T45, T50, T55, T60
	314810M	3792 3779-08G

Ratchet Screwdriver & Set

2166DF

- Two position L-handle design for greater torque
- PC+TPR Handle

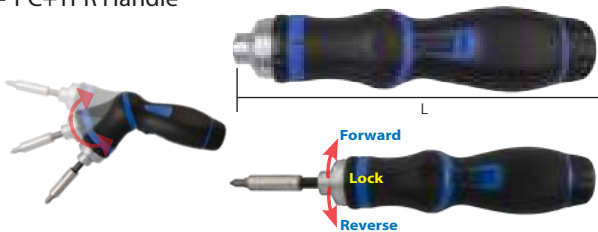

KT NO.	Gear	Overall Length (mm)		
2166DF	46 teeth	167	0.28	6 / 72

32809MR

- 9-in-1 ratchet screwdriver set
- Reversible ratchet with 1/4" bit holder



9 PC.

Contents 0.32 6 / 72

	1025S	4.0, 5.0
	1025P	PH1, PH2, PH3
	1025Z	PZ1, PZ2
	750-60	
	2166DF	

2555MR

1/4"

- Ratchet screwdriver set
- Blow case size (mm) : 260 x 160 x 64 (0.094 cuft)



55 PC.

Contents 1.00 1 / 10

	1025S	3.0, 4.0, 4.5, 5.0, 5.5, 6.0, 6.5, 8.0
	1025P	PH0, PH1, PH2, PH3
	1025Z	PZ0, PZ1, PZ2, PZ3
	1025T	T10, T15, T20, T25, T27, T30, T40
	1025H	H2, H2.5, H3, H4, H5, H6, H8
	1025U	T10H, T15H, T20H, T25H, T27H, T30H, T40H
	1025R	RB1, RB2
	7702-25	
	750-60	
	2335M	4, 4.5, 5, 5.5, 6, 7, 8, 9, 10, 11, 12, 13, 14
	2166DF	



Palm Ratchet Screwdriver & Set



2746 1/4"

- 48 teeth
- With an internal soft structure, it allows the operator to spin fasteners on and off in hard-to-reach areas
- Stubby grip fitting the palm, good to use in a confined space

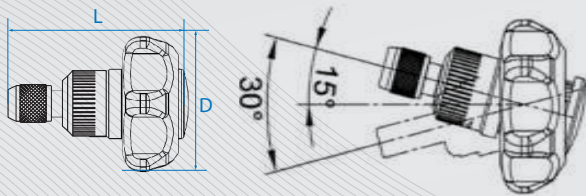

KT NO.	D (mm)	L (mm)			
2746	60	72	95	1	48



1048MR 1/4"

Contents

0.53 1 / 12

	1025S	3.0 x 0.5, 4.0 x 0.5, 5.0 x 0.8, 6.0 x 1.0
	1025P	PH1 x 2, PH2 x 2 ø6mm, PH3, PH2 ø4.7mm
	1025T	T10, T15, T20 x 2, T25, T27, T30, T40
	1025H	H3, H4, H5, H6
	1025U	T10H, T15H, T20H x 2, T25H, T27H, T30H, T40H
	1025Z	P22 x 2
	7150T	T15, T20, T25,
	7150P	PH2 x 2
	7150Z	P22
	7150S	4.0 x 0.8, 6.0 x 1.0
	7150H	H3, H4, H5, H6, H7, H8
	750-75	1/4"
	753-63	1/4"



49 PC.

Plastic case size (mm) : 150 x 102 x 46 (0.025 cuft)

Ratchet Screwdriver & Set



32808MR 1/4"

- 8-in-1 ratchet screwdriver set
- Reversible ratchet screwdriver with max torque 45 Nm
- 45 teeth
- Magnetic nut setter 1/4" and bit holder
- Extended blades max. 135mmL
- Extended drive gets into hard-to-reach space easily

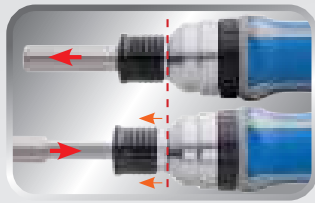

▪ Extended magnetic bit holder



▪ Forward, reverse and neutral



▪ 6 bit storage compartment cap

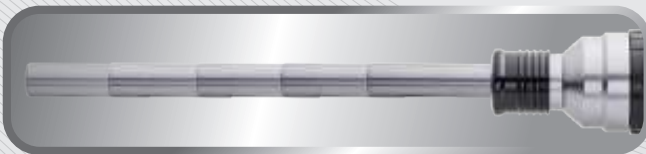

▪ Telescopic ratchet screwdriver

Contents

Kg 0.27 1 / 48

	1025P	PH1, PH2
	1025Z	PZ2
	1025S	4.0 x 0.5, 5.5 x 0.8, 6.5 x 1.2
	2155-06	
	2155DF	

32526MRN

Contents

Kg 0.7 1 / 30

	PH1		PH2	1317012PN
	4.0		6.0	1317046SN
	5.0		7.0	1317057SN
	T10		T15	1317115TN
	T20		T25	1317225TN
	B4		H4	131744BHN
	B5		H5	131755BHN
	B6		H6	131766BHN
	2155DF			



Contents

	1025S	4.0, 5.5, 6.5
	1025P	PH1, PH2
	1025Z	PZ2
	2155-06	



Ratchet Screwdriver Set



32540MR

Contents

0.58 kg 1 / 12

⊖	1025S	3.0, 4.0, 5.0, 6.0
⊕	1025P	PH1, PH2 x 2, PH3
⊗	1025Z	PZ1, PZ2 x 2, PZ3
⊛	1025T	T10, T15, T20, T25, T27, T30, T40
⦿	1025H	H3, H4, H5, H6
⊛	1025U	T10H, T15H, T20H, T25H, T27H, T30H, T40H
■	7702-25	
○	753-63	
⊖	1025P	PH1, PH2
⊗	1025Z	PZ2
⊕	1025S	4.0 x 0.5, 5.5 x 0.8, 6.5 x 1.2
—	2155-06	
—	2155DF	

- Suitable for fixing, repairing and installation work, and can also be used with power tools, with ratchet driver included to complete the work without power tools



40 PC.

+



2539MRV04

- Suitable for fixing, repair and installation work

Contents

1.25 kg 1 / 16

○	2335M	5, 6, 7, 8, 9, 10, 11, 12, 13, 14
⊖	1025S	4.0 x 0.5, 5.5 x 0.8, 6.5 x 1.2
⊕	1025P	PH1, PH2
⊗	1025Z	PZ2
⦿	1025H	H1.5, H2, H2.5, H3, H4, H5, H6
⊛	1025U	T7H, T8H, T9H, T10H, T15H, T20H, T25H, T27H, T30H, T40H
■	7702-25	
—	2155-06	
—	2155DF	
1317012PN	⊕ PH1	⊕ PH2
1317046SN	⊖ 4.0	⊖ 6.0
1317057SN	⊖ 5.0	⊖ 7.0

39 PC.



Atom Series

Asymmetrical line design

PAT.

26
PC.



1026CQ-AM

Plastic case size (mm) :
140 x 65 x 36

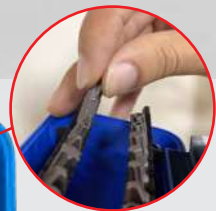

▪ Easy to pick up



▪ Automatic raising bit rack



▪ Suitable in pocket

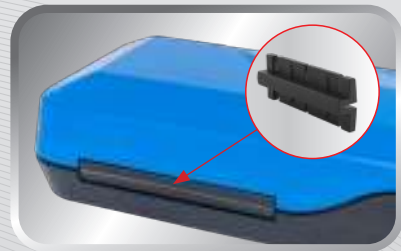

▪ Built-in rotation axis design

Contents

0.39 kg 1 / 40

⊕	1025P	PH1, PH2, PH3
⊗	1025Z	PZ1, PZ2, PZ3
⊛	1025U	T10H, T15H, T20H, T25H, T30H
●	1025H	H3, H4, H5, H6, H8
⊛	1025T	T10, T15, T20, T25, T27, T30, T40
■	7702-25	
○	753-63	
—	276B-35	



Bit Set

- Silicon chrome vanadium alloy steel (S2)
- Anti-rust oiled, sand-blasted

1032CQ

Plastic case size (mm) :
120 x 70 x 42 (0.012 cuft)



32
PC.

Contents

0.30 1 / 20

	1025S	3.0, 4.0, 5.0, 6.0
	1025P	PH1, PH2 x 2, PH3
	1025Z	PZ1, PZ2 x 2, PZ3
	1025T	T10, T15, T20, T25, T27, T30, T40
	1025H	H3, H4, H5, H6
	1025U	T10H, T15H, T20H, T25H, T27H, T30H, T40H
	7702-25	
	753-63	

1032CQ01

Plastic case size (mm) :
120 x 70 x 42 (0.012 cuft)



33
PC.

Contents

0.30 1 / 20

	1025S	3.0, 4.0, 5.0, 6.0
	1025P	PH1, PH2 x 2, PH3
	1025Z	PZ1, PZ2 x 2, PZ3
	1025T	T10, T15, T20, T25, T27, T30, T40
	1025H	H3, H4, H5, H6
	1025U	T10H, T15H, T20H, T25H, T27H, T30H, T40H
	1025R	RB2
	7702-25	
	753-63	

Bit Set

KT NO.

PC.

Contents



102502P-S1	25	1025P	PH2 x 25 PC.	161	12 / 72
102502Z-S1	25	1025Z	PZ2 x 25 PC.	161	12 / 72
102510T-S1	25	1025T	T10 x 25 PC.	136	12 / 72
102515T-S1	25	1025T	T15 x 25 PC.	140	12 / 72
102520T-S1	25	1025T	T20 x 25 PC.	142	12 / 72
102525T-S1	25	1025T	T25 x 25 PC.	144	12 / 72
102530T-S1	25	1025T	T30 x 25 PC.	146	12 / 72



Power Driving

7100P



- Short neck (9.5 mm) type
- DIN ISO 2351-2



KT NO.	⊕ No.	Overall length (mm)	g	g	g
715000P	PH0	50	8		
715001P	PH1	50	9		
715002P	PH2	50	11		
715003P	PH3	50	11		
715004P	PH4	50	14		10 / 150
716502P	PH2	65	15		
717001P	PH1	70	16		
717002P	PH2	70	17		
717003P	PH3	70	17		
719001P	PH1	90	18		
719002P	PH2	90	20		
719003P	PH3	90	20		
711002P	PH2	100	24		10 / 120
711501P	PH1	150	23		
711502P	PH2	150	33		
711503P	PH3	150	33		

7100H



- DIN ISO 2351-3



KT NO.	mm / inch	Overall length (mm)	g	g	g
715002H	H2	50	6		
715025H	H2.5	50	6		
715003H	H3	50	6		
715004H	H4	50	9		
715005H	H5	50	10		
715006H	H6	50	11		
715007H	H7	50	13		
715008H	H8	50	17		
715012SH	3/16	50	20		10 / 150
715014SH	7/32	50	22		
717002H	H2	70	8		
717025H	H2.5	70	8		
717003H	H3	70	9		
717004H	H4	70	13		
717005H	H5	70	15		
717006H	H6	70	18		
717007H	H7	70	21		
717008H	H8	70	25		
711102H	H2	110	11		
711125H	H2.5	110	11		
711103H	H3	110	14		
711104H	H4	110	18		10 / 120
711105H	H5	110	24		
711106H	H6	110	29		
711107H	H7	110	34		
711108H	H8	110	42		
711110H	H10	110	62		8 / 80
711502H	H2	150	16		
711503H	H3	150	18		
711504H	H4	150	25		
711505H	H5	150	34		10 / 120
711506H	H6	150	40		
711507H	H7	150	47		
711508H	H8	150	59		

- Silicon chrome vanadium alloy steel (S2)
- Anti-rust oiled, phosphate sunk
- Magnetic **1/4"** Hex size shank driver



order unit : one blister card

7150S



- DIN ISO 2351-1



KT NO.	Tip width (mm)	Tip thickness (mm)	Overall length (mm)	g	g
715003S1	3.0	0.5	50	6	
715035S1	3.5	0.5	50	6	
715004S2	4.0	0.5	50	7	
715004S1	4.0	0.8	50	7	
715045S1	4.5	0.6	50	7	10 / 150
715005S1	5.0	0.8	50	8	
715055S1	5.5	0.8	50	8	
715006S1	6.0	1.0	50	8	
715065S1	6.5	1.2	50	9	

7100T



- For torx head screw



KT NO.	Size	Overall length (mm)	g	g	g
715006T	T6	50	5		
715007T	T7	50	5		
715008T	T8	50	5		
715009T	T9	50	5		
715010T	T10	50	6		
715015T	T15	50	6		
715020T	T20	50	7		
715025T	T25	50	8		
715027T	T27	50	9		
715030T	T30	50	9		
715040T	T40	50	10		
715050T	T50	50	15		10 / 150
717006T	T6	70	7		
717007T	T7	70	7		
717008T	T8	70	7		
717009T	T9	70	7		
717010T	T10	70	8		
717015T	T15	70	8		
717020T	T20	70	10		
717025T	T25	70	11		
717027T	T27	70	14		
717030T	T30	70	14		
717040T	T40	70	15		
711110T	T10	110	14		
711115T	T15	110	14		
711120T	T20	110	18		
711125T	T25	110	19		
711127T	T27	110	24		
711130T	T30	110	24		
711140T	T40	110	28		
711506T	T6	150	16		
711507T	T7	150	16		10 / 120
711508T	T8	150	16		
711509T	T9	150	16		
711510T	T10	150	17		
711515T	T15	150	18		
711520T	T20	150	24		
711525T	T25	150	24		
711527T	T27	150	32		
711530T	T30	150	33		
711540T	T40	150	39		



Power Driving

7100Z



• DIN ISO 2351-2



KT NO.	⊕ No.	Overall length (mm)	g	10 / 150
715001Z	PZ1	50	9	10 / 150
715002Z	PZ2	50	11	
715003Z	PZ3	50	12	
717001Z	PZ1	70	11	
717002Z	PZ2	70	15	10 / 120
717003Z	PZ3	70	15	
719001Z	PZ1	90	13	
719002Z	PZ2	90	19	10 / 120
719003Z	PZ3	90	19	

7100U



• For torx head screw
• Tamper-resistant type



KT NO.	⊕ Size	Overall length (mm)	g	10 / 150
715009U	T9H	50	5	10 / 150
715010U	T10H	50	7	
715015U	T15H	50	7	
715020U	T20H	50	7	
715025U	T25H	50	8	
715027U	T27H	50	9	
715030U	T30H	50	9	
715040U	T40H	50	11	
717010U	T10H	70	8	
717015U	T15H	70	8	
717020U	T20H	70	10	
717025U	T25H	70	11	
717027U	T27H	70	13	
717030U	T30H	70	13	
717040U	T40H	70	15	
711110U	T10H	110	14	10 / 120
711115U	T15H	110	14	
711120U	T20H	110	18	
711125U	T25H	110	19	
711127U	T27H	110	24	
711130U	T30H	110	24	
711140U	T40H	110	28	

7100R



KT NO.	⊕ Size	Overall length (mm)	g	10 / 150
715000R	RBO	50	7	10 / 150
715001R	RB1	50	8	
715002R	RB2	50	8	
715003R	RB3	50	8	
717000R	RBO	70	9	
717001R	RB1	70	11	
717002R	RB2	70	13	
717003R	RB3	70	13	

2128PR



• torx head tamper-resistant & L-type holder set



8 PC.

Contents

0.17 10 / 60

7170U	T10H, T15H, T20H, T25H, T27H, T30H, T40H
158902ERA	

- Silicon chrome vanadium alloy steel (S2)
- Anti-rust oiled, phosphate sunk
- Magnetic **1/4"** Hex size shank driver



order unit : one blister card

2138PR



• Hexagon head power bits & L-type holder set



8 PC.

Contents

0.24 10 / 60

7150H H2, H3, H4, H5, H6, H7, H8

158902ERA

7400P



• Short head type



KT NO.	⊕ No.	Overall length (mm)	g	10 / 150
745002P	PH2	50	11	10 / 150
747501P	PH1	75	16	10 / 150
747502P	PH2	75	15	10 / 150
747503P	PH3	75	16	10 / 150
741002P	PH2	100	23	10 / 120
741502P	PH2	150	37	10 / 100
742002P	PH2	200	50	10 / 100
743002P	PH2	300	70	10 / 40
743003P	PH3	300	77	10 / 40

7300P



• Long head type



KT NO.	⊕ No.	Overall length (mm)	g	10 / 150
734501P	PH1	45	9	10 / 150
734502P	PH2	45	9	
734503P	PH3	45	10	
736501P	PH1	65	14	
736502P	PH2	65	14	10 / 120
736503P	PH3	65	14	
731101P	PH1	110	26	
731102P	PH2	110	26	
731103P	PH3	110	26	
731502P	PH2	150	32	10 / 120
731503P	PH3	150	33	



5mm Hex size shank driver order unit : one box

Insert Size: The suggested size is according to the depth of bit holder which a bit is inserted.

7200P



• Long head typed



KT NO.	⊕ No.	Overall length (mm)	g	10 / 100
726502P	PH2	65	8	10 / 100
727502P	PH2	75	10	
721102P	PH2	110	14	



Power Driving

7100P-S1



- Short neck (9.5 mm) type
- DIN ISO 2351-2



KT NO.	No.	Overall length (mm)	g	set / box
715000P-S1	PH0	50	16	1 / 20
715001P-S1	PH1	50	18	
715002P-S1	PH2	50	22	
715003P-S1	PH3	50	22	
715004P-S1	PH4	50	28	
716502P-S1	PH2	65	30	
717001P-S1	PH1	70	32	
717002P-S1	PH2	70	34	
717003P-S1	PH3	70	34	
719001P-S1	PH1	90	36	
719002P-S1	PH2	90	40	
719003P-S1	PH3	90	40	
711002P-S1	PH2	100	48	
711501P-S1	PH1	150	46	
711502P-S1	PH2	150	66	
711503P-S1	PH3	150	66	

7100H-S1



- DIN ISO 2351-3



KT NO.	mm / inch	Overall length (mm)	g	set / box
715002H-S1	H2	50	12	1 / 20
715025H-S1	H2.5	50	12	
715003H-S1	H3	50	12	
715004H-S1	H4	50	18	
715005H-S1	H5	50	20	
715006H-S1	H6	50	22	
715007H-S1	H7	50	26	
715008H-S1	H8	50	34	
715012SH-S1	3/16	50	20	
715014SH-S1	7/32	50	22	
717005H-S1	H5	70	30	
717006H-S1	H6	70	36	
711102H-S1	H2	110	22	
711125H-S1	H2.5	110	22	
711103H-S1	H3	110	28	
711104H-S1	H4	110	36	
711105H-S1	H5	110	48	
711106H-S1	H6	110	58	
711107H-S1	H7	110	68	
711505H-S1	H5	150	68	
711507H-S1	H7	150	94	
711512SH-S1	3/16	150	68	

- Silicon chrome vanadium alloy steel (S2)
- Anti-rust oiled, phosphate sunk
- Magnetic
- 2 PC. bits set **1/4" Hex size shank driver** order unit : one blister card



7150S-S1



- DIN ISO 2351-1



KT NO.	Tip width (mm)	Tip thickness (mm)	Overall length (mm)	g	set / box
715003S1-S1	3.0	0.5	50	12	1 / 20
715035S1-S1	3.5	0.5	50	12	
715004S2-S1	4.0	0.5	50	14	
715004S1-S1	4.0	0.8	50	14	
715045S1-S1	4.5	0.6	50	14	
715005S1-S1	5.0	0.8	50	16	
715055S1-S1	5.5	0.8	50	16	
715006S1-S1	6.0	1.0	50	16	
715065S1-S1	6.5	1.2	50	18	

7100T-S1



- For torx head screw



KT NO.	Size	Overall length (mm)	g	set / box
715006T-S1	T6	50	10	1 / 20
715007T-S1	T7	50	10	
715008T-S1	T8	50	10	
715009T-S1	T9	50	10	
715010T-S1	T10	50	12	
715015T-S1	T15	50	12	
715020T-S1	T20	50	14	
715025T-S1	T25	50	16	
715027T-S1	T27	50	18	
715030T-S1	T30	50	18	
715040T-S1	T40	50	20	
715050T-S1	T50	50	30	
717006T-S1	T6	70	14	
717007T-S1	T7	70	14	
717008T-S1	T8	70	14	
717009T-S1	T9	70	14	
717010T-S1	T10	70	14	
717015T-S1	T15	70	16	
717020T-S1	T20	70	16	
717025T-S1	T25	70	20	
717027T-S1	T27	70	22	
717030T-S1	T30	70	28	
717040T-S1	T40	70	28	
711110T-S1	T10	110	30	
711115T-S1	T15	110	28	
711120T-S1	T20	110	28	
711125T-S1	T25	110	36	
711127T-S1	T27	110	38	
711130T-S1	T30	110	48	
711140T-S1	T40	110	48	
711506T-S1	T6	150	56	
711507T-S1	T7	150	32	
711508T-S1	T8	150	32	
711509T-S1	T9	150	32	
711510T-S1	T10	150	34	
711515T-S1	T15	150	36	
711520T-S1	T20	150	48	
711525T-S1	T25	150	48	
711527T-S1	T27	150	64	
711530T-S1	T30	150	66	
711540T-S1	T40	150	78	



Power Driving

7100Z-S1



- DIN ISO 2351-2



KT NO.	No.	Overall length (mm)	g	set / box
715001Z-S1	PZ1	50	18	1 / 20
715002Z-S1	PZ2	50	22	
715003Z-S1	PZ3	50	24	
717001Z-S1	PZ1	70	22	
717002Z-S1	PZ2	70	30	
717003Z-S1	PZ3	70	30	
719001Z-S1	PZ1	90	26	
719002Z-S1	PZ2	90	38	
719003Z-S1	PZ3	90	38	

7100U-S1



- For torx head screw
- Tamper-resistant type



KT NO.	Size	Overall length (mm)	g	set / box
715009U-S1	T9H	50	10	1 / 20
715010U-S1	T10H	50	14	
715015U-S1	T15H	50	14	
715020U-S1	T20H	50	14	
715025U-S1	T25H	50	16	
715027U-S1	T27H	50	18	
715030U-S1	T30H	50	18	
715040U-S1	T40H	50	22	
717010U-S1	T10H	70	16	
717015U-S1	T15H	70	16	
717020U-S1	T20H	70	20	
717025U-S1	T25H	70	22	
717027U-S1	T27H	70	26	
717030U-S1	T30H	70	26	
717040U-S1	T40H	70	30	
711110U-S1	T10H	110	28	
711115U-S1	T15H	110	28	
711120U-S1	T20H	110	36	
711125U-S1	T25H	110	38	
711127U-S1	T27H	110	48	
711130U-S1	T30H	110	48	
711140U-S1	T40H	110	56	

7100R-S1



KT NO.	Size	Overall length (mm)	g	set / box
715000R-S1	RB0	50	14	1 / 20
715001R-S1	RB1	50	16	
715002R-S1	RB2	50	16	
715003R-S1	RB3	50	16	
717000R-S1	RB0	70	18	
717001R-S1	RB1	70	22	
717002R-S1	RB2	70	26	
717003R-S1	RB3	70	26	

- Silicon chrome vanadium alloy steel (S2)

- Anti-rust oiled, phosphate sunk

- Magnetic

- 2 PC. bits set

1/4" Hex size shank driver

order unit : one blister card



7400P-S1



- Short head type



KT NO.	No.	Overall length (mm)	g	set / box
745002P-S1	PH2	50	22	1 / 20
747501P-S1	PH1	75	32	
747502P-S1	PH2	75	30	
747503P-S1	PH3	75	32	
741002P-S1	PH2	100	46	
741502P-S1	PH2	150	74	

7300P-S1



- Long head type



KT NO.	No.	Overall length (mm)	g	set / box
734501P-S1	PH1	45	18	1 / 20
734502P-S1	PH2	45	18	
734503P-S1	PH3	45	20	
736501P-S1	PH1	65	28	
736502P-S1	PH2	65	28	
736503P-S1	PH3	65	28	
731101P-S1	PH1	110	52	
731102P-S1	PH2	110	52	
731103P-S1	PH3	110	52	
731502P-S1	PH2	150	64	
731503P-S1	PH3	150	66	

Insert Size: The suggested size is according to the depth of bit holder which a bit is inserted.

5mm Hex size shank driver

order unit : one box



7200P-S1



- Long head typed



KT NO.	No.	Overall length (mm)	g	set / box
726502P-S1	PH2	65	16	1 / 20
727502P-S1	PH2	75	20	
721102P-S1	PH2	110	28	

Power Driving

- Silicon chrome vanadium alloy steel (S2)
- Nickel plated
- Magnetic

1/4" Hex size shank driver



order unit : one box

1300P



- Long head type



KT NO.	⊕ No.	Overall length (mm)	g	g	g
134501P	PH1	45	8	10 / 300	
134502P	PH2	45	9	10 / 300	
134503P	PH3	45	9	10 / 300	
136501P	PH1	65	14	10 / 200	
136502P	PH2	65	14	10 / 200	
136503P	PH3	65	14	10 / 200	
131101P	PH1	110	26	10 / 150	
131102P	PH2	110	26	10 / 150	
131103P	PH3	110	26	10 / 150	
131501P	PH1	150	36	10 / 100	
131502P	PH2	150	36	10 / 100	
131503P	PH3	150	37	10 / 100	

1500P



- Short head type



KT NO.	⊕ No.	Overall length (mm)	g	g	g
155001P	PH1	50	10	10 / 300	
155002P	PH2	50	10	10 / 300	
155003P	PH3	50	10	10 / 300	
157501P	PH1	75	16	10 / 200	
157502P	PH2	75	16	10 / 200	
157503P	PH3	75	17	10 / 200	
151001P	PH1	100	23	10 / 150	
151002P	PH2	100	23	10 / 150	
151003P	PH3	100	23	10 / 150	
151501P	PH1	150	36	10 / 100	
151502P	PH2	150	37	10 / 100	
151503P	PH3	150	37	10 / 100	

7300P



- Long head type



KT NO.	⊕ No.	Tip width (mm)	Tip thickness (mm)	Overall length (mm)	g	g	g
734551P	PH1	5.0	0.8	45	8	10 / 300	
734552P	PH2	5.0	0.8	45	8	10 / 300	
736552P	PH2	5.0	0.8	65	13	10 / 200	
731152P	PH2	5.0	0.8	110	25	10 / 150	
731552P	PH2	5.0	0.8	150	36	10 / 100	

- Silicon chrome vanadium alloy steel (S2)
- Anti-rust oiled, phosphate sunk
- Magnetic

1/4" Hex size shank driver



order unit : one box

13A6502P



- Long head type
- For ironwork screws



KT NO.	⊕ No.	Overall length (mm)	g	g	g
13A6502P	PH2	65	8	10 / 100	

13B6502P



- Long head type
- For woodwork screws



KT NO.	⊕ No.	Overall length (mm)	g	g	g
13B6502P	PH2	65	8	10 / 100	

- Chrome vanadium & stainless alloy steel
- Anti-rust oiled , sand-blasted
- Magnetic

1/4" Hex size shank driver



750

750-50A



- Magnetic bit holder
- 750-50A : with spring clip
- DIN 7427



KT NO.	inch	Overall length (mm)	g	g	g
750-60	1/4	60	20	6 / 84	
750-50A	1/4	50	22	6 / 84	

KT NO.	inch	Overall length (mm)	g	g	g
750-75	1/4	75	30	1 / 20	
750-100	1/4	100	37	1 / 20	
750-150	1/4	150	50	1 / 20	

751



- Magnetic bit holder
- With spring clip
- DIN 7427



KT NO.	inch	Overall length (mm)	g	g	g
751-60	1/4	60	24	6 / 84	
751-75	1/4	75	36	6 / 84	



Power Driving

752

- Magnetic bit holder
- With quick-release sleeve
- DIN 7427



KT NO.	inch	Overall length (mm)		
752-60	1/4	63	33	6 / 72
752-75	1/4	75	32	1 / 12
752-100	1/4	100	38	1 / 12
752-150	1/4	150	52	1 / 12
752-300	1/4	300	92	1 / 12

753

- 753-63
- Magnetic bit holder
- With quick-release sleeve
- For 1025 bit
- DIN 7427



KT NO.	inch	Overall length (mm)		
753-63	1/4	63	33	6 / 72

Angle Driver

759

- Heavy duty right angle bit holder
- This heavy duty 90 degree offset driver with 24 position gripped stabilizer arm is designed for use with power drivers 18-24 Volts
- Its head is shorter than 2.5" which is suitable to use in limited space
- Locking magnetic chuck accepts any 1/4" hex drive accessory such as twist drills, spade drills, step drills, grinding stones, buffer pads, nut drivers and screwdriver bits
- Durable all metal housing and steel gears with ball bearing construction
- Gripped stabilizer arm with 1 screwdriver bit storage
- It's amazing capacity for up to 500 inch lbs with 2000 RPM

KT NO.	inch	Overall length (mm)		
759-140	1/4	140	305	12 / 48

- Chrome vanadium & stainless alloy steel
- Anti-rust oiled , sand-blasted
- Magnetic

1/4" Hex size shank driver

754

- Universal joint bit holder
- 20 degree pivot mode allows for limited space accessibility
- Can be used in straight or pivot mode



KT NO.	inch	Overall Length (mm)		
754-90	1/4	90	52	1 / 12

755

- Quick release flexible bit holder
- Flexible shaft driver
- The flex shaft accepts any standard hex fitting
- Quick release fits double end power bits and 50mm power bits



KT NO.	inch	Overall length (mm)		
755-300	1/4	300	293	1 / 12
755-400	1/4	400	385	1 / 8

- The body is zin alloy steel
- The arm is chrome vanadium alloy steel
- The chuck is aluminum alloy steel
- Magnetic

1/4" Hex size shank driver

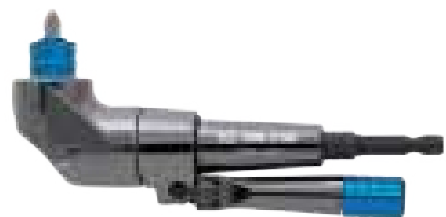
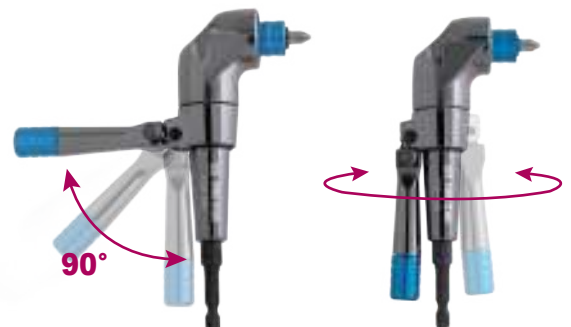

Power Driving

- Chrome vanadium alloy steel
- Anti-rust oiled, sand-blasted

1/4" Hex size shank driver



75A1

- Threaded rod socket
- Fastest tool available to tighten or loosen threaded rods
- Automatic locking cams
- Will not damage the threads when used properly

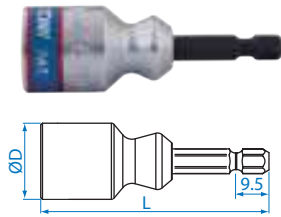

KT NO.	Size mm	Inch	D mm	L mm	Capacity Ø mm	g	kg
75A105M	5	3/16	22	66	4.6~5.0	60	10 / 72
75A106M	6	1/4	24	66	5.6~6.35	75	10 / 80
75A108M	8	5/16	24	66	7.6~8.0	74	10 / 80
75A110M	10	3/8	28	66	9.0~10.0	99	10 / 107
75A112M	12	1/2	28	66	11.4~12.7	98	10 / 103
75A114M	14	9/16	32	66	13.2~14.3	126	10 / 127
75A116M	16	5/8	32	66	15.2~16.0	125	10 / 125

760M

- Nut setter
- Non magnetic type
- DIN 3126

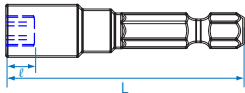

760S



KT NO.	mm	mm	Overall length (mm)	g	kg
7605512M	12	7.0	55	55	6 / 72
7606512M	12	6.8	65	50	6 / 72
7607510M	10	6.0	75	38	6 / 72

KT NO.	mm	mm	Overall length (mm)	g	kg
7601012M	12	7.5	100	61	1 / 25
7601013M	13	7.0	100	70	1 / 25

KT NO.	Inch	mm	Overall length (mm)	g	kg
7606508S	1/4	4.8	65	20	6 / 84
7606510S	5/16	6.6	65	30	6 / 84
7606512S	3/8	6.8	65	36	6 / 72

761M

- Nut setter
- Magnetic type
- DIN 3126

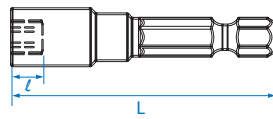

KT NO.	mm	mm	Overall length (mm)	g	kg
7616505M	5	2.3	65	27	6 / 84
7616506M	6	2.6	65	26	6 / 84
7616507M	7	2.9	65	25	6 / 84
7616508M	8	3.5	65	30	6 / 84
7616510M	10	4.5	65	37	6 / 72
7616512M	12	5.6	65	52	6 / 72
7616513M	13	6.0	65	54	6 / 72
7616514M	14	6.5	65	52	6 / 20

KT NO.	mm	mm	Overall length (mm)	g	kg
7611006M	6	2.6	100	38	1 / 25
7611008M	8	3.5	100	48	1 / 25
7611010M	10	4.5	100	54	1 / 25
7611012M	12	5.6	100	68	1 / 25
7611013M	13	6.0	100	71	1 / 25
7611014M	14	6.5	100	77	1 / 25
7611506M	6	2.6	150	58	1 / 25
7611507M	7	2.9	150	65	1 / 25
7611508M	8	3.5	150	67	1 / 25
7611510M	10	4.5	150	68	1 / 25
7611512M	12	5.6	150	103	1 / 25
7611513M	13	6.0	150	110	1 / 25
7611514M	14	6.5	150	115	1 / 25
7612006M	6	2.6	200	78	1 / 20
7612008M	8	3.5	200	93	1 / 20
7612010M	10	4.5	200	89	1 / 20
7612012M	12	5.6	200	128	1 / 20
7612014M	14	6.5	200	128	1 / 20

KT NO.	Inch	mm	Overall length (mm)	g	kg
7614208S	1/4	2.7	42	15	6 / 84
7614210S	5/16	3.7	42	17	6 / 84
7614512S	3/8	4.7	45	22	6 / 84
7616508S	1/4	4.8	65	30	6 / 84
7616510S	5/16	6.6	65	31	6 / 84
7616512S	3/8	6.8	65	37	6 / 72
7616514S	7/16	6.8	65	39	6 / 72



Power Driving

- Chrome vanadium alloy steel
- Anti-rust oiled, sand-blasted

1/4" & 3/8" & 1/2"
Hex size shank driver



76B



- Deep well nut setter
- Deep hole for bolt & nut
- Press-fitted high-durability shank
- Use for tightening step clamp in construction

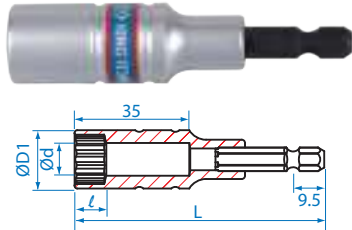

KT NO.	mm	D1 mm	ℓ mm	d mm	L mm	g	kg	1/8
76B808M	8	13	6	6	80	41	15	300
76B809M	9	13	6	7	80	40	15	300
76B812M	12	17	8	9	80	57	12	240
76B813M	13	18	9	10	80	62	12	240
76B814M	14	20	9	12	80	70	12	240
76B815M	15	21	10	12	80	77	12	240
76B816M	16	22	10	14	80	76	12	240
76B819M	19	26	13	15	80	112	10	120
76B821M	21	28	13	19	80	113	10	120

76C



- 110mm length easy to reach at confined spaces
- Extra depth dimension 63mm perfectly go through various bolts
- Press-fit structure with durability socket suitable for 18V power tools
- Ideal for construction assembling, scaffolding and roof work

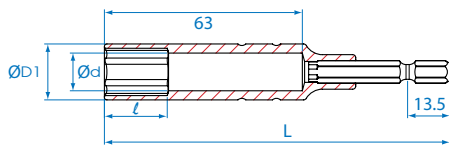

KT NO.	mm	D1 mm	ℓ mm	d mm	L mm	g	kg	1/8
76C1108M	8	14.0	12	7	110	71	12	216
76C1109M	9	14.0	14	8	110	64	12	216
76C1110M	10	15.0	15	9	110	67	12	216
76C1111M	11	17.0	17	10	110	84	10	180
76C1112M	12	17.0	18	11	110	74	10	180
76C1113M	13	18.0	20	12	110	79	10	180
76C1114M	14	20.0	21	13	110	99	10	180
76C1117M	17	24.0	26	16	110	139	10	180
76C1119M	19	26.0	29	18	110	158	10	180
76C1121M	21	28.0	30	20	110	161	8	144
76C1123M	23	29.8	30	22	110	200	8	96
76C1124M	24	32.0	30	23	110	216	8	96

Impact Construction Socket Set

1010CMR

Plastic case size (mm) :
252 x 200 x 52 (0.095 cuft)

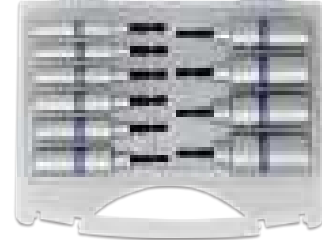

10
PC.

Contents

1.66 kg 1/8

76C 8, 10, 12, 13, 14, 17, 19, 21, 23, 24

770

- Socket adapter
- Ball retainer type
- DIN 7428

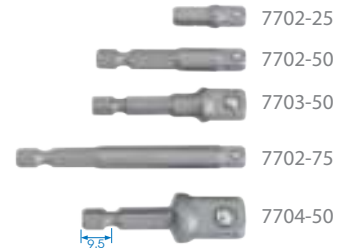

KT NO.	Size	Overall length (mm)	g	kg
7702-25	1/4"	25	6	20 / 200
7702-50	1/4"	50	13	10 / 100
7702-75	1/4"	75	23	10 / 100
7703-50	3/8"	50	23	6 / 84
7704-50	1/2"	50	24	6 / 72

774

- Bit adapter
- Wobble function provides up to 15° accessibility

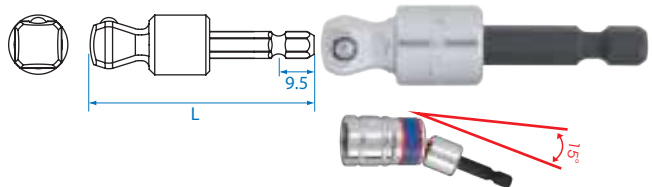

KT NO.	Size	L mm	g	kg
7743-56	3/8"	56	30	6 / 72
7744-60	1/2"	60	42	6 / 72

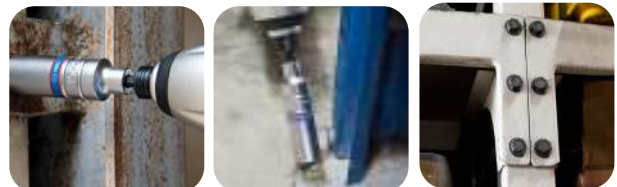

Power Bit Pocket Case

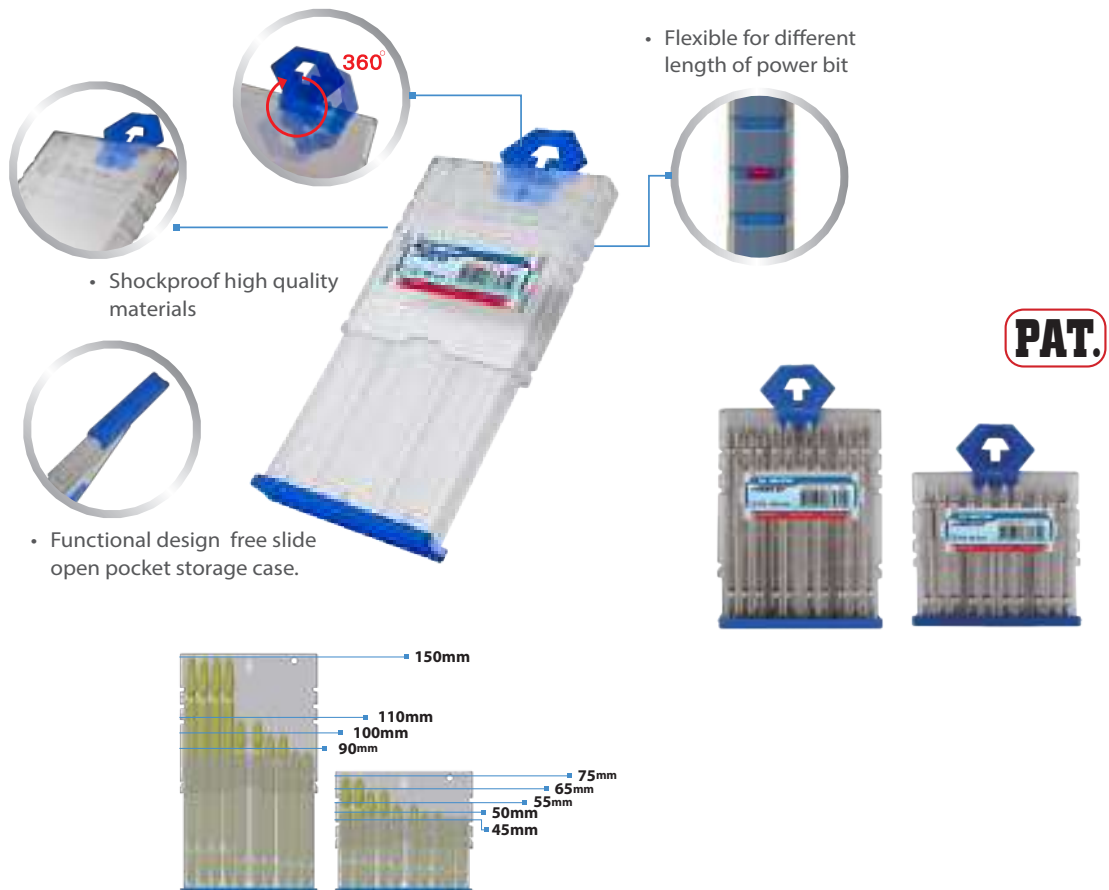

Spot Weld Drill Bit

7E511

- Material : HSS M35
- Special drill bit for removal of spot welds effectively
- Two cutting edge

KT NO.	Diameter mm	Length mm		
7E51180-60	8	60	32	100 / 600
7E51180-80	8	80	35	100 / 600



Titanium Coated HSS Drill Bit Set

11101SQ

1/4"

- Titanium coated HSS drill set with standard 1/4" hex shank that will fit cordless screwdrivers, hand drills and impact drivers etc. or use in standard drill chuck
- Suitable for use with steel, wood, plastic etc
- Titanium nitride drill bits run cooler, drill smoother and last longer than standard bits
- High speed steel
- 120 deg. tips
- 1/4" hex shank for fast changes

Ø mm	Overall length mm
1.5	62
2	69
2.5	77
3	82
3.2	85
3.5	90
4	95
4.5	100
4.8	105
5	106



10 PC.



Power Driving Set

1035MR

1/4"

Plastic case size (mm) : 150 x 103 x 46 (0.025 cuft)

Contents		Kg 0.62	1 / 32
⊖	1025S	3.0 x 0.5, 4.0 x 0.5, 5.0 x 0.8, 6.0 x 1.0	
⊕	1025P	PH1 x 2, PH2 x 2 \varnothing 6mm, PH2 \varnothing 4.7mm, PH3	
⊛	1025T	T15, T20 x 2, T25 x 2, T30 x 2, T40	
⊙	1025H	H3, H4, H5, H6	
⊛	1025Z	PZ2 x 2	
○	7E111	2.5, 3.0, 3.5, 4.0, 5.0	
○	754-90	1/4"	
○	7400P	PH2	
○	761M x 65L	8, 10, 13	
○	752-60	1/4"	



35 PC.

1036MR

1/4"

Plastic case size (mm) : 150 x 103 x 46 (0.025 cuft)

Contents		Kg 0.59	1 / 32
⊖	1025S	3.0 x 0.5, 4.0 x 0.5, 5.0 x 0.8, 6.0 x 1.0	
⊕	1025P	PH1 x 2, PH2 x 2 \varnothing 6mm, PH2 \varnothing 4.7mm, PH3	
⊛	1025T	T15, T20 x 2, T25 x 2, T30 x 2, T40	
⊙	1025H	H3, H4, H5, H6	
⊛	1025Z	PZ2 x 2	
⊛	7150T	T20, T25, T30	
⊛	7150Z	PZ2 x 2	
⊖	7150S	5.5 x 0.8	
⊕	7450P	PH2 x 2	
○	761M x 65L	8, 10, 13	
○	753-63	1/4"	



36 PC.

1044MR

1/4"

Plastic case size (mm) : 150 x 103 x 46 (0.025 cuft)

Contents		Kg 0.63	1 / 32
⊖	1025S	3.0 x 0.5, 4.0 x 0.5, 5.0 x 0.8, 6.0 x 1.0	
⊕	1025P	PH1 x 2, PH2 x 2 \varnothing 6mm, PH2 \varnothing 4.7mm, PH3	
⊛	1025T	T10, T15, T20 x 2, T25, T27, T30, T40	
⊙	1025H	H3, H4, H5, H6	
⊛	1025U	T10H, T15H, T20H x 2, T25H, T27H, T30H, T40H	
⊛	1025Z	PZ2 x 2	
⊛	7170T	T15, T20, T25,	
⊕	7170P	PH2 x 2	
⊛	7170Z	PZ2	
⊖	7150S	4.0 x 0.8, 6.0 x 1.0	
○	761M x 65L	6, 8, 10	
○	753-63	1/4"	



44 PC.



















Power Driving Set

1045MR

1/4"

Plastic case size (mm) : 150 x 103 x 46 (0.025 cuft)

Contents	 0.64	 /  1 / 32
 1025S	4.0 x 0.5, 5.5 x 0.8, 6.5 x 1.2	
 1025P	PH2 x 2 ø4.7mm	
 1025T	T10, T15, T20, T25, T27, T30, T35, T40	
 1025H	H2, H3, H4, H5, H6	
 1025U	T10H, T15H, T20H x 2, T25H, T27H, T30H, T40H	
 1025Z	PZ1, PZ2, PZ3	
 1025R	RB1, RB2, RB3	
 1550P	PH1, PH2 x 2, PH3	
 7150P	PH2	
 7E111	3, 4, 5	
 761M x 65L	8, 10, 13	
 750-50A	1/4"	
 7702-50	1/4" DR.	















45
PC.

1049CQ

1/4"

Plastic case size (mm) : 150 x 103 x 46 (0.025 cuft)

Contents	 0.51	 /  1 / 32
 1025P	PH1 x 2, PH2 x 2 ø6mm, PH2 x 2 ø4.7mm, PH3 x 2	
 1025S	4.0 x 0.5 x 2, 5.5 x 0.8 x 2, 6.5 x 1.2 x 2	
 1025H	H2, H2.5, H3, H4, H5, H6, H7, H8	
 1025Z	PZ1 x 2, PZ2 x 2, PZ3 x 2	
 1025U	T9H, T10H, T15H, T20H, T25H, T27H, T30H, T40H	
 1025T	T9, T10, T15, T20, T25, T27, T30, T40	
 1025R	RB1, RB2,	
 2141	1/4" DR. x 1/4"H	
 750-50A	1/4"	
 7702-25	1/4" DR.	



49
PC.



Power Driving Set



1045MR01-EB

Contents

0.97 1 / 12

	1025S	4.0 x 0.5, 5.5 x 0.8, 6.5 x 1.2
	1025P	PH2 x 2 ø4.7mm
	1025T	T10, T15, T20, T25, T27, T30, T35, T40
	1025H	H2, H3, H4, H5, H6
	1025U	T10H, T15H, T20H x 2, T25H, T27H, T30H, T40H
	1025Z	PZ1, PZ2, PZ3
	1025R	RB1, RB2, RB3
	1550P	PH1, PH2 x 2, PH3
	7150P	PH2
	7E111	3, 4, 5
	761M x 65L	8, 10, 13
	750-50A	1/4"
	7702-50	1/4"
	759-140	



45
PC.

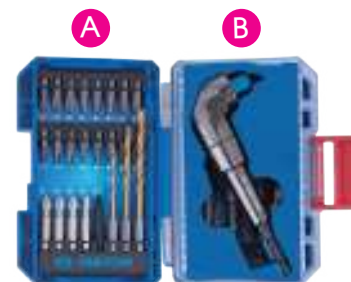

2547MR-EB

Contents

1.0 1 / 12

	2335M	4, 4.5, 5, 5.5, 6, 7, 8, 9, 10, 11, 12, 13, 14
	2375M	E4, E5, E6, E7, E8, E10
	2031	PH1, PH2, PH3
	2032	3.5, 4, 5.5, 6.5, 8
	2033	T8, T9, T10, T15, T20, T25, T27, T30, T40
	2035	H3, H4, H5, H6, H8
	2038	PZ1, PZ2
	2813	1/4"F x 3/8"M
	7702-50	1/4" DR.
	7703-50	3/8" DR.
	7704-50	1/2" DR.

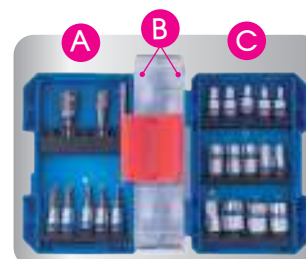

47
PC.



Power Driving Set



1041CQ-EB

Contents

2.1 1 / 12

	1636M	M5, M6, M8, M9, M10, M12, M14
	1636U	T10H, T15H, T20H, T25H, T27H, T30H, T40H, T45H, T50H, T55H, T60H
	1636H	H5, H6, H8, H10
	1680M	M5, M6, M8, M9, M10, M12, M14
	1680U	T10H, T15H, T20H, T25H, T27H, T30H, T40H, T45H, T50H, T55H, T60H
	414810M	

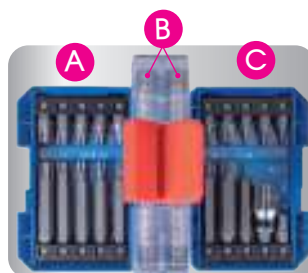

41
PC.



Hex Key & Set

KT No. & D1

- Material - SNCM - V alloy steel
- Finishing - chrome plated

1145MR

- Standard arm type
- Allen head
- DIN ISO 2936



KT NO.	mm	mm	mm	g	kg
114515MR	H1.5	16	47	1	20 / 400
114502MR	H2	18	52	1	20 / 400
114525MR	H2.5	21	59	3	20 / 400
114503MR	H3	24	66	5	20 / 400
114504MR	H4	30	74	10	20 / 400
114505MR	H5	33	85	18	20 / 400
114555MR	H5.5	36	91	23	10 / 200
114506MR	H6	38	97	29	10 / 200
114507MR	H7	41	102	43	10 / 200
114508MR	H8	44	108	58	10 / 200
114510MR	H10	50	122	101	10 / 200

1145SR



KT NO.	inch	mm	mm	g	kg
114502SR	1/16	18	49	1	20 / 400
114525SR	5/64	20	52	1.5	20 / 400
114503SR	3/32	21	56	3	20 / 400
114504SR	1/8	25	63	5	20 / 400
114505SR	5/32	28	70	9	20 / 400
114506SR	3/16	31	77	15	20 / 400
114508SR	1/4	37	91	31	10 / 200
114510SR	5/16	42	106	55	10 / 200
114512SR	3/8	47	120	93	10 / 120
114516SR	1/2	54	146	195	10 / 120
114518SR	9/16	59	160	267	6 / 72
114520SR	5/8	64	175	362	6 / 72
114524SR	3/4	73	203	599	6 / 24

1125MR

- Extra long arm type
- Allen head
- DIN ISO 2936

KT NO.	mm	mm	mm	g	kg
112515MR	H1.5	16	92	1	20 / 400
112502MR	H2	18	102	3	20 / 400
112525MR	H2.5	21	115	5	20 / 400
112503MR	H3	23	129	9	20 / 480
112504MR	H4	29	144	17	20 / 300
112505MR	H5	33	165	31	20 / 300
112506MR	H6	38	186	51	20 / 400
112507MR	H7	41	197	74	20 / 240
112508MR	H8	44	208	100	10 / 100
112510MR	H10	50	234	176	10 / 100
112512MR	H12	57	262	286	8 / 48
112514MR	H14	70	294	445	8 / 48
112517MR	H17	80	337	770	4 / 32
112519MR	H19	89	380	863	4 / 16
112522MR	H22	102	422	1590	2 / 16

1125SR



KT NO.	inch	mm	mm	g	kg
112502SR	1/16	16	92	2	20 / 400
112525SR	5/64	18	102	3	20 / 400
112503SR	3/32	21	115	5	20 / 400
112504SR	1/8	23	129	9	20 / 400
112505SR	5/32	29	144	17	20 / 300
112506SR	3/16	33	165	28	20 / 300
112508SR	1/4	38	186	57	10 / 100
112510SR	5/16	44	208	100	10 / 100
112512SR	3/8	50	234	160	10 / 100
112516SR	1/2	57	262	319	8 / 48
112518SR	9/16	70	294	459	8 / 48



KT NO.	PC.	Spec.	Contents	kg	kg
20218MR	8	Knife type	H2, H2.5, H3, H4, H5, H6, H8, H10	0.29	12 / 72
20219MR	9	Standard arm	1145MR H1.5, H2, H2.5, H3, H4, H5, H6, H8, H10	0.33	6 / 48
20219SR	9		1145SR 1/16, 5/64, 3/32, 1/8, 5/32, 3/16, 1/4, 5/16, 3/8	0.33	6 / 48
20208MR	8	Extra long arm	1125MR H2, H2.5, H3, H4, H5, H6, H8, H10	0.43	8 / 48
20209MR	9		1125MR H1.5, H2, H2.5, H3, H4, H5, H6, H8, H10	0.49	8 / 48
20209SR02	9		1125SR 1/16, 5/64, 3/32, 1/8, 5/32, 3/16, 1/4, 5/16, 3/8	0.47	8 / 48



Hex Key Set

20208MR01

20208SR01

20210MR



8 PC.



10 PC.

Metal case size (mm) :
372 x 153 x 40 (0.08 cuft)

KT NO.	Spec.	Contents	Kg	1.25	1 / 20
20208MR01	Extra long arm	● 1125MR H3, H4, H5, H6, H8, H10, H12, H14			
20208SR01	arm	● 1125SR 1/8, 5/32, 3/16, 1/4, 5/16, 3/8, 1/2, 9/16			

Spec.	Contents	Kg	3.03	1 / 6
Extra long arm	● 1125MR H3, H4, H5, H6, H7, H8, H10, H12, H14, H17			

L- wrench Set With Display Stnad

2020H0MR

- 5mm durable acrylic sheets to increase structural strength
- Transparent design for demonstrating product feature
- Great capacity, suitable for multi-size
- Size : 220 x 260 x 270mm



KT NO. 87125



80 PC.

Spec.	Contents	Kg	7.68	1 / 4	Each Q'ty
Extra long arm	● 1125MR H2, H2.5, H3, H4, H5, H6, H7, H8, H10, H12				8

Spline L- wrench & Set

1146MR

- Standard arm type
- For spline head screw



KT NO.	Size	mm	mm	Kg	15	20 / 320
114605MR	M5	29	83			
114606MR	M6	33	90			
114608MR	M8	39	98			
114610MR	M10	44	111			
114612MR	M12	53	126			

1126MR

- Extra long arm type



KT NO.	Size	mm	mm	Kg	29	20 / 300
112605MR	M5	33	165			
112606MR	M6	38	186			
112608MR	M8	44	208			
112610MR	M10	50	234			
112612MR	M12	53	264			

20505PR01

20515PR01



5 PC.

KT NO.	Spec.	Contents	Kg	0.33	6 / 54
20505PR01	Standard arm type	● 1146MR M5, M6, M8, M10, M12			
20515PR01	Extra long arm type	● 1126MR M5, M6, M8, M10, M12			



Ball Hex Key & Set

KT No. & D1

- Material - SNCM - V alloy steel
- Finishing - chrome plated

1130MR

- Long arm with ball point type
- DIN ISO 2936

KT NO.	mm	mm	mm	g	kg/cb
113015MR	H1.5	16	64	1	20 / 400
113002MR	H2	18	77	2	20 / 400
113025MR	H2.5	21	88	4	20 / 400
113003MR	H3	23	93	7	20 / 400
113004MR	H4	29	104	14	20 / 400
113005MR	H5	33	120	25	20 / 300
113006MR	H6	38	141	41	10 / 160
113008MR	H8	44	158	84	10 / 150
113010MR	H10	50	180	145	10 / 150

1130SR



KT NO.	inch	mm	mm	g	kg/cb
113002SR	1/16	18	80.0	2	20 / 400
113025SR	5/64	19	85.0	2	20 / 400
113003SR	3/32	21	90.0	4	20 / 400
113004SR	1/8	24	101.0	8	20 / 400
113005SR	5/32	27	111.0	14	20 / 400
113006SR	3/16	30	121.0	24	20 / 300
113007SR	7/32	34	131.0	31	10 / 150
113008SR	1/4	36	142.0	44	10 / 150
113010SR	5/16	42	162.5	78	10 / 150
113012SR	3/8	46	183.0	138	10 / 150

1120MR

- Extra long arm with ball point type
- DIN ISO 2936



KT NO.	mm	mm	mm	g	kg/cb
112015MR	H1.5	16	92	1	20 / 400
112002MR	H2	18	102	3	20 / 400
112025MR	H2.5	21	115	5	20 / 400
112003MR	H3	23	129	9	20 / 480
112004MR	H4	29	144	17	20 / 300
112005MR	H5	33	165	31	20 / 300
112006MR	H6	38	186	51	20 / 400
112007MR	H7	41	197	73	20 / 400
112008MR	H8	44	208	99	10 / 100
112010MR	H10	50	234	174	10 / 100



20107MR01

20109MR

20119MR01

KT NO.	PC.	Spec.	Contents	kg	kg/cb
20107MR01	7	Long arm / ball	1130MR H2.5, H3, H4, H5, H6, H8, H10	0.37	10 / 60
20107SR	7		1130SR 3/32, 1/8, 5/32, 3/16, 1/4, 5/16, 3/8	0.36	10 / 60
20108MR	8	Extra long arm / ball	1120MR H2, H2.5, H3, H4, H5, H6, H8, H10	0.43	8 / 48
20109MR	9		1120MR H1.5, H2, H2.5, H3, H4, H5, H6, H8, H10	0.49	8 / 48
20119MR01	9	Long arm / ball	1120MR H1.5, H2, H2.5, H3, H4, H5, H6, H7, H8	0.36	6 / 48
20110MR	9		1130MR H1.5, H2, H2.5, H3, H4, H5, H6, H8, H10	0.39	6 / 60
20129SR	9		1130SR 1/16, 5/64, 3/32, 1/8, 5/32, 3/16, 1/4, 5/16, 3/8	0.39	6 / 60



9 PC. Color Coded Extra Long Arm Ball End Hex Key Set

20109MW

- Color coded according to size makes it easy to distinguish and allows for faster work
- This professional ball hex key is made of S2 material
- The unique design at the bottom of the ball head has an inclination angle of 25 degrees that allows for easy operation in narrow spaces
- The rack can be opened, and the wrenches are easy to take out
- Easy to identify with the internal engravings

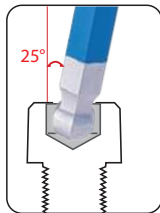

color	mm	L mm
	H1.5	92
	H2	102
	H2.5	115
	H3	129
	H4	144
	H5	165
	H6	186
	H8	208
	H10	234

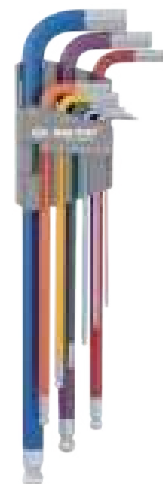

KT NO.	PC.	Spec.	Contents		
20109MW	9	Extra long arm / ball	H1.5, H2, H2.5, H3, H4, H5, H6, H8, H10	0.45	6 / 36

20109MW-S

Paper display stand size(mm) :
238 x 95 x 303 (0.24 CUFT)

Contents		
x 8 Sets 20109MW	3.57	1 / 4



8 Sets



Star L- wrench

KT No. & D1

- Material - SNCM - V alloy steel
- Finishing - chrome plated

1143R



- Standard arm type
- For torx head screw



KT NO.	Size	mm	mm		
114310R	T10	19	49	3	20 / 400
114315R	T15	20	57	5	20 / 400
114320R	T20	23	62	7	20 / 400
114325R	T25	25	70	10	20 / 400
114327R	T27	29	77	14	20 / 400
114330R	T30	35	86	23	10 / 200
114340R	T40	42	97	37	10 / 200
114345R	T45	47	110	54	10 / 200
114350R	T50	50	124	76	10 / 200

1147R



- Standard arm type
- Tamper-resistant type
- For torx head screw



KT NO.	Size	mm	mm		
114710R	T10H	18	50	3	20 / 400
114715R	T15H	20	56	5	20 / 400
114720R	T20H	24	62	7	20 / 400
114725R	T25H	26	68	10	20 / 400
114727R	T27H	30	76	14	20 / 400
114730R	T30H	36	86	23	10 / 200
114740R	T40H	41	97	36	10 / 200
114745R	T45H	46	107	54	10 / 200
114750R	T50H	52	122	75	10 / 200

1123R



- Extra long arm type
- For torx head screw



KT NO.	Size	mm	mm		
112310R	T10	18	92	6	20 / 400
112315R	T15	20	103	9	20 / 400
112320R	T20	22	115	12	20 / 400
112325R	T25	25	130	18	20 / 300
112327R	T27	29	146	25	20 / 300
112330R	T30	35	165	40	20 / 300
112340R	T40	40	182	61	10 / 100
112345R	T45	45	202	89	10 / 100
112350R	T50	49	225	126	10 / 100

1127R



- Extra long arm type
- Tamper-resistant type
- For torx head screw



KT NO.	Size	mm	mm		
112710R	T10H	18	92	5	20 / 400
112715R	T15H	20	103	8	20 / 400
112720R	T20H	22	115	12	20 / 400
112725R	T25H	25	130	17	20 / 300
112727R	T27H	29	146	25	20 / 300
112730R	T30H	35	165	40	20 / 300
112740R	T40H	40	182	60	10 / 100
112745R	T45H	45	202	89	10 / 100
112750R	T50H	49	225	126	10 / 100



• 1123R



• 1147R



Extension Pipe

- Material - Extension pipe: iron
- L-wrench: SNCM - V alloy steel
- Finishing - chrome plated

20002UB

128 6/36

Contents	Overall length (mm)	AØ mm	BØ mm
S : 5 x 6mm	110	11	10
L : 8 x 10mm	150	16	14

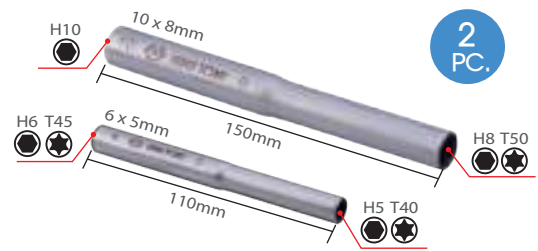



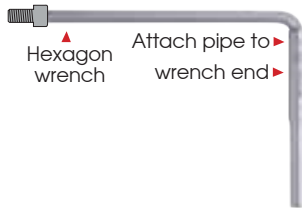

L- wrench & Extension Pipe Set



Caution :
Please be careful not to overtighten.
Do not use any other L-wrench that is incompatible with the pipe size.



KT NO.	PC.	Spec.	Contents	Kg	Box
20109MRU	11	Extra long arm / ball	 1120MR  20002UB H1.5, H2, H2.5, H3, H4, H5, H6, H8, H10 5 x 6, 8 x 10	0.62	11 / 66
20319PRU	11	Extra long arm	 1123R  20002UB T10, T15, T20, T25, T27, T30, T40, T45, T50 5(T40) x 6(T45), 8(T50) x 10	0.67	11 / 66

Star L-wrench Set











knife type



Standard arm



Extra long arm

KT NO.	PC.	Spec	Contents	Kg	Box
20307PR	7	Standard arm	 1143R T10, T15, T20, T25, T27, T30, T40	0.13	15 / 120
20407PR	7	Standard arm / Tamper-resistant	 1147R T10H, T15H, T20H, T25H, T27H, T30H, T40H	0.13	15 / 120
20308PR	8	Knife type	 T9, T10, T15, T20, T25, T27, T30, T40	0.20	12 / 72
20318PR	8		 T9H, T10H, T15H, T20H, T25H, T27H, T30H, T40H	0.20	12 / 72
20309PR	9	Standard arm	 1143MR T10, T15, T20, T25, T27, T30, T40, T45, T50	0.30	6 / 48
20319PR	9	Extra long arm	 1123R T10, T15, T20, T25, T27, T30, T40, T45, T50	0.45	8 / 48
20409PR	9	Standard arm / Tamper-resistant	 1147R T10H, T15H, T20H, T25H, T27H, T30H, T40H, T45H, T50H	0.34	6 / 48
20419PR	9	Extra long arm / Tamper-resistant	 1127R T10H, T15H, T20H, T25H, T27H, T30H, T40H, T45H, T50H	0.47	8 / 48



Stubby L- wrench Set

- The "SPECIAL SHORT ARM" L1 length is designed to be 1/3 as short as other wrenches to allow easy work in cramped places
- The "SPECIAL SHORT ARM" is made with a 90 degree bend for high workability in small spaces without risk of pinched fingers

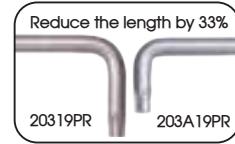
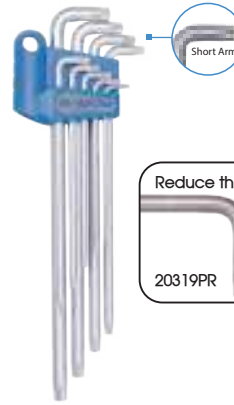
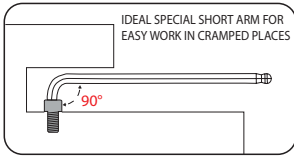

KT NO.	PC.	Spec.	Contents	Kg	Box
201A09MR	9	Extra long arm / ball	H1.5, H2, H2.5, H3, H4, H5, H6, H8, H10	0.45	10 / 60
203A19PR	9	Extra long arm	T10, T15, T20, T25, T27, T30 T40, T45, T50	0.45	10 / 60

Ball Hex Key & Set

201B09MR

- Set of ball head offset key wrench, extra long arm



KT NO.	PC.	Spec.	Contents	Kg	Box
201B09MR	9	Extra long arm / ball	H1.5, H2, H2.5, H3, H4, H5, H6, H8, H10	0.45	8 / 48

Ball End Star L-wrench Set

204B29PR

- Set of ball head offset key wrench, long modle, for torx internal screw

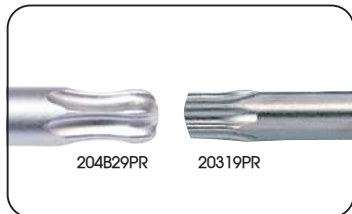
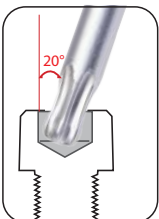

KT NO.	PC.	Spec.	Contents	Kg	Box
204B29PR	9	Standard arm / ball	T10, T15, T20, T25, T27, T30, T40, T45, T50	0.37	6 / 48



Bicycle Repair Tool

20A16MR

▪ 16-in-1 bicycle repair tool set

Contents		300	10 / 60
●	H2, H2.5, H3, H4, H5, H6		
○	8, 9, 10 mm		
⊕	PH2		
⊖	5.0		
Spoke Wrench: 14GE		Extension bar 1/4" DR.	
Wrench: 8 / 10 / 15 mm			



20A17MR

▪ 20-in-1 bicycle repair tool set

Contents		305	10 / 60
●	H2, H2.5, H3, H4, H5, H6		
○	9, 10, 12, 13, 15		
⊕	PH2		
⊖	5.0		
○	Socket : 8mm		
Spoke Wrench: 14GE / 15GE / 0.136"			
Chain Wrench x 1		Tire Lever x 2	



Aluminum Folding Hex Key Wrench Set

20317MR

▪ 7-in-1 aluminum folding hex key wrench set

Spec	Contents	90	10 / 200
knife type	● H1.5, H2, H2.5, H3, H4, H5, H6		



L- type Wrench

KT No. & D1

- Material - SNCM - V alloy steel
- Finishing - chrome plated with black tip

1160MR



- Hexagon with ball point head

KT NO.	mm	mm	mm		
116002MR	H2	95	145	14	10 / 200
116025MR	H2.5	95	145	17	10 / 200
116003MR	H3	95	145	20	10 / 200
116004MR	H4	95	145	29	10 / 200
116005MR	H5	150	215	66	10 / 200
116006MR	H6	150	215	84	10 / 200
116007MR	H7	150	215	105	10 / 200
116008MR	H8	200	280	188	10 / 80
116010MR	H10	200	280	265	10 / 80

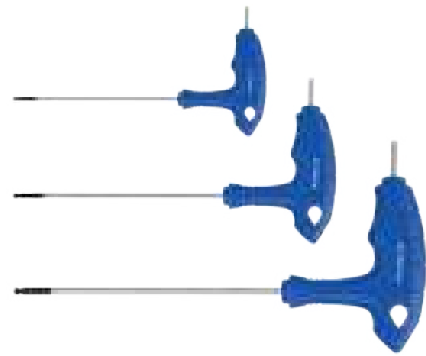

1165MR



- For hexagon head screw

KT NO.	mm	mm	mm		
116502MR	H2	95	145	14	10 / 200
116525MR	H2.5	95	145	17	10 / 200
116503MR	H3	95	145	20	10 / 200
116504MR	H4	95	145	29	10 / 200
116505MR	H5	150	215	66	10 / 200
116506MR	H6	150	215	84	10 / 200
116507MR	H7	150	215	107	10 / 200
116508MR	H8	200	280	190	10 / 80
116510MR	H10	200	280	289	10 / 80

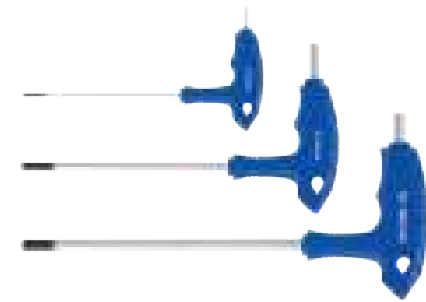

1163TR



- For torx internal screw
- Tamper-resistant type

KT NO.	Size	mm	mm		
116310TR	T10	95	145	22	10 / 200
116315TR	T15	95	145	23	10 / 200
116320TR	T20	95	145	31	10 / 200
116325TR	T25	95	145	31	10 / 200
116327TR	T27	150	215	78	10 / 200
116330TR	T30	150	215	78	10 / 200
116340TR	T40	150	215	97	10 / 200
116345TR	T45	200	280	176	10 / 80
116350TR	T50	200	280	209	10 / 80

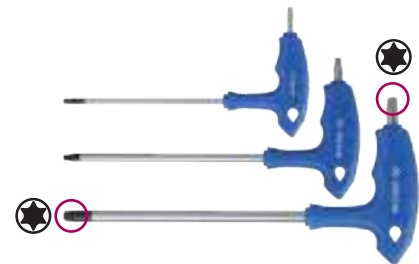

1163R



- For torx internal screw
- Tamper-resistant type

KT NO.	Size	mm	mm		
116310R	T10H	95	145	22	10 / 200
116350R	T50H	200	280	209	10 / 80

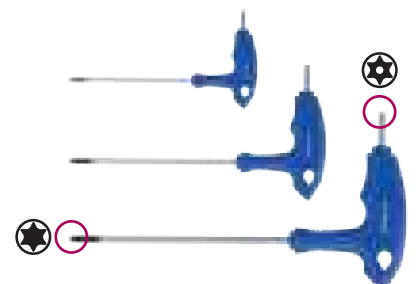

L- type Wrench Set



► Tray



► Shelf

KT NO.	PC.	Spec	Contents	Package		
22106MR	6	Ball & hex two way type	1160MR H3, H4, H5, H6, H7, H8	Tray	0.68	1 / 20
22108MR	8		1160MR H2, H2.5, H3, H4, H5, H6, H8, H10	Tray	0.97	1 / 10
22208MR	8	Hex head	1165MR H2, H2.5, H3, H4, H5, H6, H8, H10	Tray	0.97	1 / 10
22306TR	6	torx head	1163TR T10, T15, T20, T25, T30, T40	Tray	0.46	1 / 20
22309TR	9		1163TR T10, T15, T20, T25, T27, T30, T40, T45, T50	Tray	1.00	1 / 10
22118MR	8	Ball & hex two way type	1160MR H2, H2.5, H3, H4, H5, H6, H8, H10	Shelf	1.10	1 / 12
22218MR	8	Hex head	1165MR H2, H2.5, H3, H4, H5, H6, H8, H10	Shelf	1.10	1 / 12
22319TR	9	torx head	1163TR T10, T15, T20, T25, T27, T30, T40, T45, T50	Shelf	1.12	1 / 12

T - type Wrench

- Material - SNCM - V alloy steel
- Finishing - chrome plated with black tip

1150MR



- Hexagon with ball point head

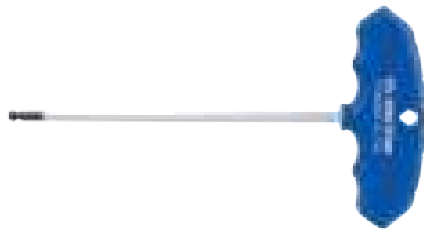

1155MR

- Hexagon head

1155SR

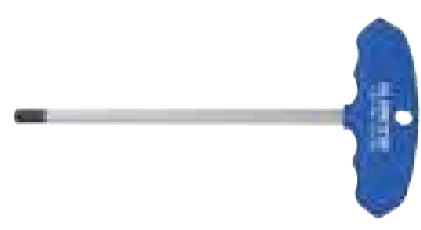

KT NO.						
115002MR	H2	100	137	90	28	10 / 200
115025MR	H2.5	100	137	90	30	10 / 200
115003MR	H3	100	137	90	32	10 / 200
115004MR	H4	100	137	90	38	10 / 200
115005MR	H5	150	188	100	65	10 / 200
115006MR	H6	150	188	100	79	10 / 200
115008MR	H8	200	240	120	159	10 / 120
115010MR	H10	200	240	120	217	10 / 120

KT NO.						
115502MR	H2	100	137	90	28	10 / 200
115525MR	H2.5	100	137	90	30	10 / 200
115503MR	H3	100	137	90	32	10 / 200
115504MR	H4	100	137	90	38	10 / 200
115505MR	H5	150	188	100	65	10 / 200
115506MR	H6	150	188	100	79	10 / 200
115508MR	H8	200	240	120	159	10 / 120
115510MR	H10	200	240	120	217	10 / 120
115525SR	5/64	100	137	90	19	10 / 200
115503SR	3/32	100	137	90	21	10 / 200
115504SR	1/8	100	137	90	25	10 / 200
115505SR	5/32	100	137	90	30	10 / 200
115506SR	3/16	150	188	100	56	10 / 200
115508SR	1/4	150	188	100	78	10 / 200
115510SR	5/16	200	240	120	158	10 / 120
115512SR	3/8	200	240	120	202	10 / 120



T - type Wrench & Set

KT No. & D1



- Material - SNCM - V alloy steel
- Finishing - chrome plated with black tip

1153R



- For torx head screw



11A3R



- For torx head screw



KT NO.	Size	mm	mm	mm	g	kg
115310R	T10	100	137	90	40	10 / 200
115315R	T15	100	137	90	40	10 / 200
115320R	T20	100	137	90	40	10 / 200
115325R	T25	100	137	90	40	10 / 200
115327R	T27	150	188	100	73	10 / 200
115330R	T30	150	188	100	74	10 / 200
115340R	T40	150	188	100	88	10 / 200
115345R	T45	200	240	120	173	10 / 120
115350R	T50	200	240	120	173	10 / 120

KT NO.	Size	mm	mm	mm	g	kg
11A310R	T10	200	237	90	53	12 / 192
11A315R	T15	200	237	90	53	12 / 192
11A320R	T20	200	237	90	53	12 / 192
11A325R	T25	200	237	90	53	12 / 192
11A327R	T27	200	238	100	86	10 / 160
11A330R	T30	200	238	100	86	10 / 160
11A340R	T40	200	238	100	105	10 / 160



KT NO.	PC.	Spec	Contents	kg	kg
21108MR	8	Ball hex type	1150MR H2, H2.5, H3, H4, H5, H6, H8, H10	1.10	1 / 12
21208MR	8	Hexagon type	1155MR H2, H2.5, H3, H4, H5, H6, H8, H10	1.10	1 / 12
21208SR	8		1155SR 5/64, 3/32, 1/8, 5/32, 3/16, 1/4, 5/16, 3/8	1.10	1 / 12
21309PR	9	torx head type	1153R T10, T15, T20, T25, T27, T30, T40, T45, T50	1.20	1 / 12

23208MR



- Perfect for when you need more leverage than a standard hex, or space is limited and you can't get a good swing on a standard wrench
- Spring and ball detent to secure the Sliding T
- It turns fasteners quickly and continuously with free spinning collar

8 PC.



- Speed & Efficiency
- Locking Stopper
- Extension



KT NO.	PC.	Spec	Contents	kg	kg
23208MR	8	Hexagon type 1195AM	H2, H2.5, H3, H4, H5, H6, H8, H10	1.64	1 / 6



T - handle Wrench

- Material - Chrome vanadium steel
- Finishing - chrome plated

1195M

- 6 Points
- For hexagon head screw
- The handle pin can be removed for another wrench
- The 10mm size is with chrome plated end

KT NO.	mm	mm	mm	g	mm
119502M	H2	64	127	22	10 / 200
119525M	H2.5	64	127	22	10 / 200
119503M	H3	64	127	22	10 / 200
119504M	H4	90	181	64	10 / 200
119505M	H5	90	182	65	10 / 200
119506M	H6	105	210	135	6 / 48
119508M	H8	124	250	224	4 / 32
119510M	H10	145	300	386	5 / 50



Wing Handle torx Screwdriver & Set

1153A



KT NO.	Size	mm	mm	mm	g	mm
1153A05R	T5	45	84	35	7	20 / 200
1153A06R	T6	45	84	35	7	20 / 200
1153A07R	T7	45	84	35	7	20 / 200
1153A08R	T8	45	84	35	7	20 / 200
1153A09R	T9	45	84	35	10	20 / 200
1153A10R	T10	45	84	35	10	20 / 200
1153A15R	T15	45	84	35	10	20 / 200
1153A20R	T20	45	84	35	10	20 / 200

23308PR



8 PC.

Contents

0.26 1 / 20



1153A

T5, T6, T7, T8, T9, T10, T15, T20

Flag Handle torx Screwdriver & Set

1163A



KT NO.	Size	mm	mm	mm	g	mm
1163A05R	T5	45	84	31	6	20 / 200
1163A06R	T6	45	84	31	6	20 / 200
1163A07R	T7	45	84	31	6	20 / 200
1163A08R	T8	45	84	31	6	20 / 200
1163A09R	T9	45	84	31	9	20 / 200
1163A10R	T10	45	84	31	9	20 / 200
1163A15R	T15	45	84	31	9	20 / 200
1163A20R	T20	45	84	31	9	20 / 200

24308PR



8 PC.

Contents

0.27 1 / 20

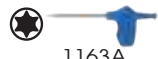

1163A

T5, T6, T7, T8, T9, T10, T15, T20



VDE INSULATED TOOLS



Ps. VDE insulated ratchet and VDE insulated socket and accessory series must be used with KING TONY VDE insulated tools.

They cannot be used with hand tools or other brands of VDE insulated tools.





Standard Socket

2335VE

1/4"

▪ IEC 60900:2012



KT NO.	mm	L mm	g	PC.
2335VE05M	5	41	14	5 / 45
2335VE06M	6	41	15	5 / 45
2335VE07M	7	41	15	5 / 45
2335VE08M	8	41	15	5 / 45
2335VE09M	9	41	16	5 / 45
2335VE10M	10	41	18	5 / 45
2335VE11M	11	41	21	5 / 45
2335VE12M	12	41	23	5 / 45
2335VE13M	13	41	23	5 / 45
2335VE14M	14	41	26	5 / 45

Bit Socket

2035VE

1/4"

▪ IEC 60900:2012



KT NO.	mm	L mm	g	PC.
2035VE03	H3	54	18	5 / 45
2035VE04	H4	54	18	5 / 45
2035VE05	H5	54	19	5 / 45
2035VE06	H6	54	20	5 / 45

Ratchet

2771VE

1/4"

▪ IEC 60900:2012



KT NO.	Overall length mm	g	PC.
2771VE-55	150	140	2 / 32

Accessory

2221VE

1/4"

IEC 60900:2012



KT NO.	Overall length mm	g	PC.
2221VE-04	100	47	4 / 36
2221VE-06	150	68	4 / 48

2178VE

1/4"

▪ IEC 60900:2012



KT NO.	mm	g	PC.
2178VE-05	125	82	4 / 40

Insulated Tool Set

25VE01MRV

1/4"

▪ IEC 60900:2012

Handy case size (mm) :
294 x 231 x 66 (1.835cuft)

Contents

1.30g PC. 1 / 10

○		2335VE	5, 6, 7, 8, 9, 10, 11, 12, 13, 14
●		2035VE	H3, H4, H5, H6
		2221VE	4, 6
		2771VE-55	2178VE-05

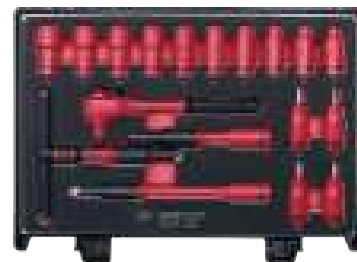

18
PC.

Standard Socket

3335VE

3/8"

▪ IEC 60900:2012



KT NO.	Ø mm	L mm		
3335VE06M	6	44.5	25	5 / 45
3335VE07M	7	44.5	26	5 / 45
3335VE08M	8	44.5	27	5 / 45
3335VE09M	9	44.5	27	5 / 45
3335VE10M	10	44.5	28	5 / 45
3335VE11M	11	44.5	29	5 / 45
3335VE12M	12	44.5	29	5 / 45
3335VE13M	13	44.5	32	5 / 45
3335VE14M	14	44.5	35	5 / 45
3335VE15M	15	46	40	5 / 45
3335VE16M	16	46	42	5 / 45
3335VE17M	17	46	47	5 / 45
3335VE18M	18	46	48	5 / 60
3335VE19M	19	46	51	5 / 60
3335VE20M	20	46	55	5 / 60
3335VE21M	21	46	59	5 / 60
3335VE22M	22	46	63	5 / 60
3335VE24M	24	46	66	5 / 60

Deep Socket

3235VE

3/8"

▪ IEC 60900:2012



KT NO.	Ø mm	L mm		
3235VE08M	8	79	52	5 / 50
3235VE10M	10	79	60	5 / 50
3235VE12M	12	79	68	5 / 50
3235VE14M	14	79	76	5 / 50

Insulated Tool Set

35VE01MRV

3/8"

▪ IEC 60900:2012

Handy case size (mm) :
389 x 229 x 66 (1.49cuft)

Contents 2.16 1 / 6

	3335VE	10, 11, 12, 13, 14, 17, 19
	3025VE	5, 6, 8,
	3221VE	6, 10,
	3771VE-08	3178VE-08

Bit Socket



3025VE

3/8"

▪ IEC 60900:2012



KT NO.	Ø mm	Overall length mm		
3025VE04	H4	65	37	5 / 50
3025VE05	H5	65	38	5 / 50
3025VE06	H6	65	39	5 / 50
3025VE08	H8	65	42	5 / 50
3025VE10	H10	65	51	5 / 50

Ratchet

3771VE

3/8"

▪ IEC 60900:2012



KT NO.	Overall length mm		
3771VE-08	200	300	2 / 20

Accessory

3221VE

3/8"

▪ IEC 60900:2012



KT NO.	Overall length mm		
3221VE-06	150	150	4 / 48
3221VE-10	250	250	4 / 24

3178VE

3/8"

▪ IEC 60900:2012



KT NO.	mm		
3178VE-08	200	240	2 / 12

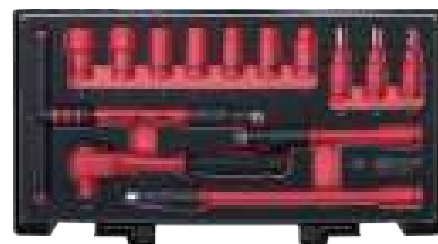

14
PC.



Standard Socket

4335VE

1/2"

IEC 60900:2012



KT NO.	mm	L mm	g	Boxes
4335VE08M	8	55	54	5 / 40
4335VE10M	10	55	55	5 / 40
4335VE11M	11	55	57	5 / 40
4335VE12M	12	55	58	5 / 40
4335VE13M	13	55	59	5 / 40
4335VE14M	14	55	62	5 / 40
4335VE15M	15	55	60	5 / 40
4335VE16M	16	55	60	5 / 40
4335VE17M	17	55	70	5 / 50
4335VE18M	18	55	77	5 / 50
4335VE19M	19	55	72	5 / 50
4335VE20M	20	55	80	5 / 50
4335VE21M	21	55	73	5 / 50
4335VE22M	22	55	87	5 / 50
4335VE24M	24	55	96	5 / 50
4335VE27M	27	59	125	5 / 50
4335VE30M	30	59	146	5 / 50
4335VE32M	32	59	170	5 / 50

Bit Socket

4025VE

1/2"

IEC 60900:2012



KT NO.	mm	Overall length mm	g	Boxes
4025VE04	H4	75	78	5 / 50
4025VE05	H5	75	78	5 / 50
4025VE06	H6	75	79	5 / 50
4025VE08	H8	75	80	5 / 50
4025VE10	H10	75	89	5 / 50

4035VE

1/2"

IEC 60900:2012



KT NO.	mm	Overall length mm	g	Boxes
4035VE04	H4	120	99	5 / 50
4035VE05	H5	120	99	5 / 50
4035VE06	H6	120	100	5 / 50
4035VE08	H8	120	102	5 / 50
4035VE10	H10	120	121	5 / 50

Ratchet

4771VE

1/2"

IEC 60900:2012



KT NO.	Overall length mm	g	Boxes
4771VE-10	250	570	2 / 20

Accessory

4251VE

1/2"

IEC 60900:2012



KT NO.	Overall length mm	g	Boxes
4251VE-05	125	210	4 / 40
4251VE-10	250	410	4 / 40

4178VE

1/2"

IEC 60900:2012



KT NO.	mm	g	Boxes
4178VE-08	200	330	2 / 12

Insulated Tool Set

45VE01MRV

1/2"

IEC 60900:2012
Handy case size (mm) :
389 x 229 x 66 (1.49cuft)

Contents

3.22g 1 / 6

	4335VE	8, 10, 12, 13, 14, 17, 19, 21, 22, 24
	4025VE	H8, H10
	4251VE	5, 10
	4771VE-10	4178VE-08

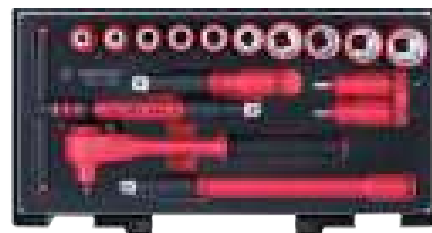

16 PC.



Open End Wrench & Set



10FOVE

IEC 60900:2012

KT NO.	Size mm	L mm		
10FOVE-07	7	88	20	5 / 50
10FOVE-08	8	104	26	5 / 50
10FOVE-09	9	104	26	5 / 50
10FOVE-10	10	114	40	5 / 50
10FOVE-11	11	124	60	5 / 50
10FOVE-12	12	124	60	5 / 50
10FOVE-13	13	154	90	5 / 50
10FOVE-14	14	154	90	5 / 50
10FOVE-15	15	171	127	5 / 50
10FOVE-16	16	170	125	5 / 50
10FOVE-17	17	170	125	5 / 50



KT NO.	Size mm	L mm		
10FOVE-18	18	180	150	5 / 50
10FOVE-19	19	180	150	5 / 50
10FOVE-20	20	202	215	5 / 50
10FOVE-21	21	202	215	5 / 50
10FOVE-22	22	202	215	5 / 50
10FOVE-23	23	238	323	5 / 40
10FOVE-24	24	237	318	5 / 40



► MRN : Teton pouch bag



KT NO.	PC.	Contents	Package		
12FVE08MRN	8	10, 11, 12, 13, 14, 17, 18, 19	Teton	0.91	1 / 10
12FVE10MRN	10	10FOVE 10, 11, 12, 13, 14, 16, 17, 18, 19, 22	Teton	1.28	1 / 10

75° Offset Ring Wrench

10GOVE

IEC 60900:2012

KT NO.	Size mm	L mm		
10GOVE-07	7	149	62	5 / 50
10GOVE-08	8	164	70	5 / 50
10GOVE-09	9	164	70	5 / 50
10GOVE-10	10	174	80	5 / 50
10GOVE-11	11	184	90	5 / 50
10GOVE-12	12	184	90	5 / 50
10GOVE-13	13	205	140	5 / 40
10GOVE-14	14	205	140	5 / 40
10GOVE-15	15	218	164	5 / 40



KT NO.	Size mm	L mm		
10GOVE-16	16	221	185	5 / 40
10GOVE-17	17	221	185	5 / 40
10GOVE-18	18	237	235	5 / 50
10GOVE-19	19	237	235	5 / 50
10GOVE-21	21	257	295	5 / 40
10GOVE-22	22	257	295	5 / 40
10GOVE-24	24	287	390	5 / 40

Adjustable Wrench

3611VE

IEC 60900:2012

KT NO.	mm	L mm		
3611VE-06	24	164	167	4 / 32
3611VE-08	28	212	273	4 / 32
3611VE-10	32	260	497	4 / 32
3611VE-12	38	310	679	4 / 24



- Grip material-TPR • Chrome vanadium steel
- Polished head • IEC DIN EN 60900

Combination Pliers

6116

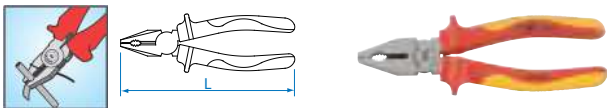

KT NO.	inch	L mm	Cutting capacities \varnothing mm				g	/
			4.0	3.0	2.0	1.6		
6116-07A	7-1/2	185	4.0	3.0	2.0	1.6	290	10 / 60
6116-08A	8	200	4.0	3.0	2.0	1.6	386	10 / 60

Cable Cutting Pliers

6146

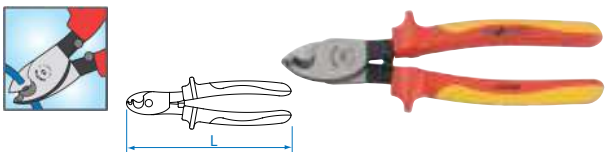

KT NO.	inch	L mm	\varnothing mm	g	/
6146-08A	8-1/4	214	14	360	10 / 60

Diagonal Cutting Pliers

6216

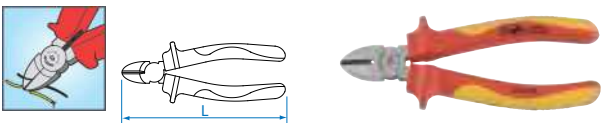

KT NO.	inch	L mm	Cutting capacities \varnothing mm				g	/
			4.0	2.8	2.0	1.6		
6216-06A	6-1/2	167	4.0	2.8	2.0	1.6	230	10 / 60

Heavy Duty Diagonal Cutting Pliers

6236

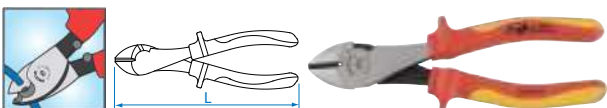

KT NO.	inch	L mm	Cutting capacities \varnothing mm				g	/
			5.0	3.5	2.4	2.0		
6236-07A	7-1/2	190	5.0	3.5	2.4	2.0	280	10 / 60

Long Nose Pliers

6318

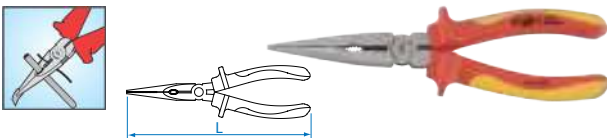

KT NO.	inch	L mm	Cutting capacities \varnothing mm				g	/
			4.0	2.8	2.0	1.6		
6318-08A	8-1/4	210	4.0	2.8	2.0	1.6	230	10 / 60

Bent Nose Pliers

6336

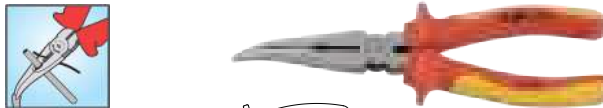

KT NO.	inch	L mm	Cutting capacities \varnothing mm				g	/
			4.0	3.0	2.0	1.6		
6336-08A	8	200	4.0	3.0	2.0	1.6	250	10 / 60

Groove Joint Pliers

6516

- Box joint

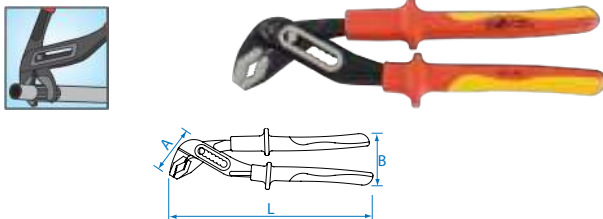

KT NO.	A mm	B mm	inch	L mm	mm	g	/

Stripping Pliers

6716

- With spring

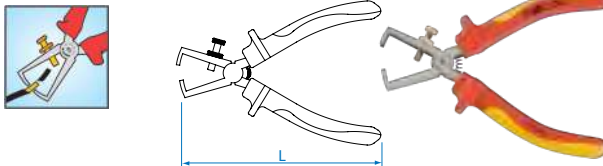

KT NO.	inch	L mm	\varnothing mm	Wire stripper mm ²	g	/
6716-06A	6-1/4	160	5	10	205	10 / 60

Insulated Pliers Set

40603GP



3 PC.

Contents

0.89 / 1 / 20



6116-07A

6318-08A

6216-06A

Insulated Screwdriver

KT No. & D1



- Shank material - SNM - V alloy steel
- Grip material - PP + TPR
- Finishing - chrome plated with black tip

1471



- Phillips head, round shank
- IEC 60900:2012

KT NO.	⊕ No.	mm		mm	g	boxes
		mm	inch			
14710003	PH0	75	3	3.0	37	12 / 144
14710104	PH1	100	4	4.5	54	12 / 216
14710204	PH2	100	4	6.0	77	12 / 144
14710306	PH3	150	6	8.0	135	12 / 144



147E



- Terminal Block Screwdriver
- Phillips / Slotted hand, round shank
- IEC 60900:2012



KT NO.	⊕ No.	mm		mm	g	boxes
		mm	inch			
147E0104	SL/PH1	100	4	4.5	61	12 / 216
147E0204	SL/PH2	100	4	6.0	85	12 / 144



1472



- Slotted head, round shank
- IEC 60900:2012

KT NO.	mm		mm		mm	g	boxes	
	mm	inch	mm	inch				
14722503	2.5	-	0.4	75	3	2.5	35	12 / 144
14720303	3	1/8	0.5	75	3	3.0	38	12 / 144
14720404	4	3/16	0.8	100	4	4.0	44	12 / 96
14723504	3.5	1/8	0.6	100	4	3.5	54	12 / 144
14725505	5.5	7/32	1	125	5	5.5	72	12 / 144
14726506	6.5	1/4	1.2	150	6	6.5	87	12 / 144
14720807	8	5/16	1.2	175	7	8.0	143	12 / 144



1474



- Square head, round shank
- IEC 60900:2012

KT NO.	□ Size	mm		mm	g	boxes
		mm	inch			
14740105	RB1	125	5	5.5	72	12 / 144
14740206	RB2	150	6	6.5	87	12 / 144



1478



- Pozidriv head, round shank
- IEC 60900:2012

KT NO.	★ Size	mm		mm	g	boxes
		mm	inch			
14780003	PZ0	75	3	3.0	37	12 / 144
14780104	PZ1	100	4	4.5	54	12 / 96
14780204	PZ2	100	4	6.0	77	12 / 144
14780306	PZ3	150	6	8.0	135	12 / 144



Insulated Screwdriver Set



- Shank material - SNCM - V alloy steel
- Grip material - PP + TPR
- Finishing - chrome plated with black tip



KT NO. PC. Contents Kg 0.86 1 / 20

30606MR	6	⊕ 1471	PH0 x 75, PH2 x 100, PH3 x 150
		⊖ 1472	3 x 75, 4 x 100, 6,5 x 150
30607MR	7	⊖ 1472	4 x 100, 5,5 x 125, 6,5 x 150, 8,0 x 175
		⊕ 1478	PZ1 x 100, PZ2 x 100, PZ3 x 150
30607MR02	7	⊕ 1471	PH1 x 100, PH2 x 100
		⊖ 1472	4 x 100, 5,5 x 125, 6,5 x 150
		⊖ 1474	1 x 125, 2 x 150
30617MR	7	⊕ 1471	PH1 x 100, PH2 x 100, PH3 x 150
		⊖ 1472	4 x 100, 5,5 x 125, 6,5 x 150, 8,0 x 175



KT NO. PC. Contents Kg 0.50 1 / 30

30605MR	5	⊖ 1472	4 x 100, 5,5 x 125, 6,5 x 150
		⊕ 1478	PZ1 x 100, PZ2 x 100
30615MR	5	⊕ 1471	PH1 x 100, PH2 x 100
		⊖ 1472	4 x 100, 5,5 x 125, 6,5 x 150



Tool Box Set

37
PC.



9052-001MRV

Plastic case size (mm) :
456 x 372 x 155 (0.93 cuft)



Pouch 1

6
PC.



Pouch 2

21
PC.



EVA foam(9-90110GPV)

10
PC.



Pouch 1

Contents

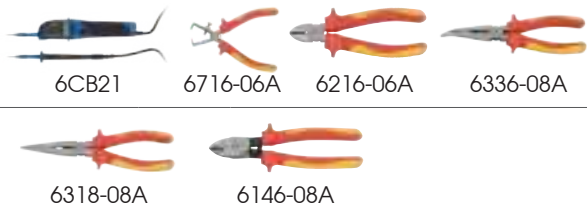

EVA foam(9-90110GPV)

Contents

8.69 1.16

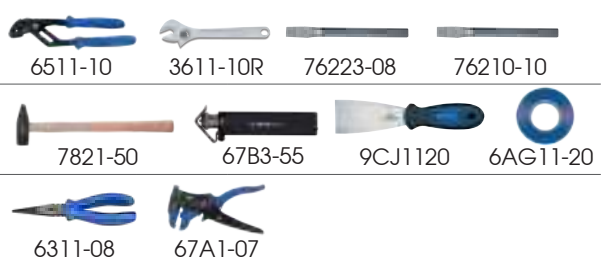

Pouch 2

Contents

	1471	PH0 x 75, PH1 x 100, PH2 x 100
	1472	3 x 75, 4 x 100, 5.5 x 125, 6.5 X 150
	1120MR	H1.5, H2, H2.5, H3, H4, H5, H6, H8, H10
	20002UB	5 x 6mm, 8 x 10mm
	6CB02	
	3611VE-08	
	79095-05M	



IC SPECIALIZED TOOLS & MEASURING TOOLS







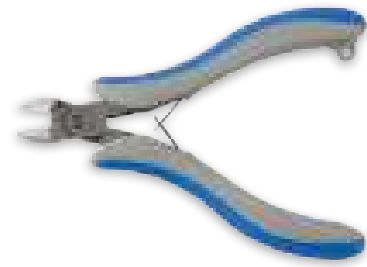
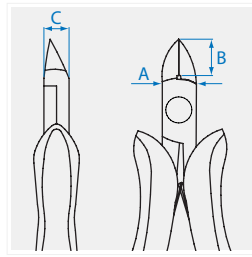

Precision Pliers

6207-05

 Diagonal cutting nippers



KT NO.	Overall length		Cutting capacities		A mm	B mm	C mm		
	inch	mm	 \varnothing mm	 \varnothing mm					
6207-05	4-3/4	118	2.0	1.6	10.8	11.5	7.1	88	6 / 120

6927-05

 For plastic

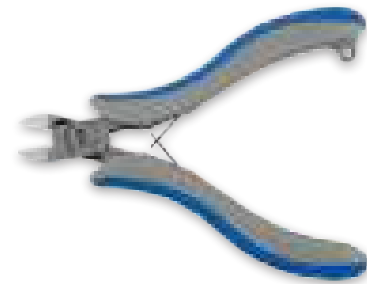
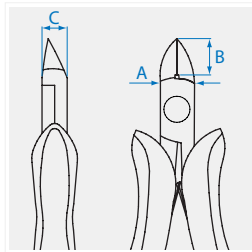



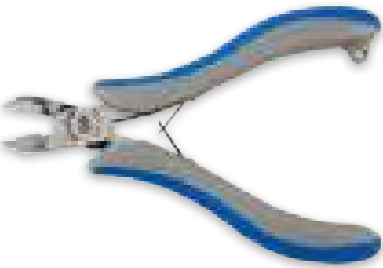
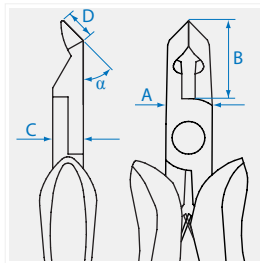
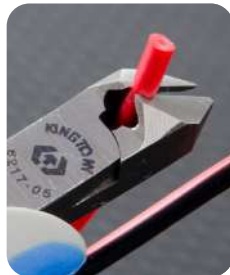
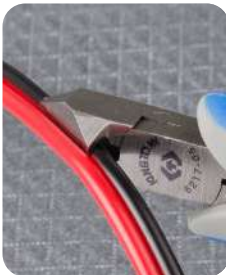

KT NO.	Overall length		A mm	B mm	C mm		
	inch	mm					
6927-05	4-3/4	118	10.3	11.5	7.1	71	6 / 120

6217-05

 Diagonal cutting nippers



KT NO.	Overall length		Cutting capacities		α	A mm	B mm	C mm	D mm		
	inch	mm	 \varnothing mm	 \varnothing mm							
6217-05	4-3/4	118	2.0	1.0	35°	11.8	17	12.7	17.7	76	6 / 120

6247-05

 Diagonal cutting nippers

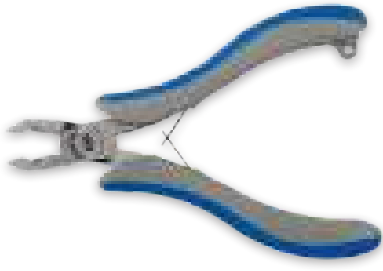
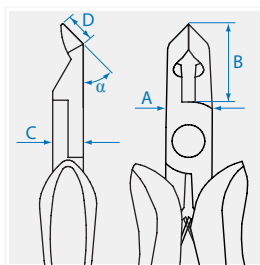

KT NO.	Overall length		Cutting capacities		α	A mm	B mm	C mm	D mm		
	inch	mm	 \varnothing mm	 \varnothing mm							
6247-05	5	125	1.0	0.5	45°	11.4	19.4	7.5	55	73	6 / 120



Precision Pliers



6271C

 Diagonal cutting nippers

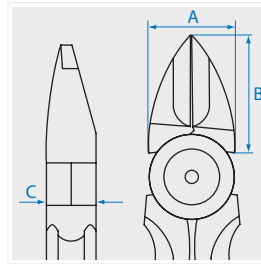
- The cutting edge hardness at least 73° HRC up







- The cutting edge is made from tungsten steel for an extremely long service life.

KT NO.	Overall length inch	mm	●	A mm	B mm	C mm		
6271-05C	5	125	0.6	13.2	15	7.1	77	6 / 120
6271-65C	6-1/2	160	0.6	19.2	26	10.7	151	6 / 120

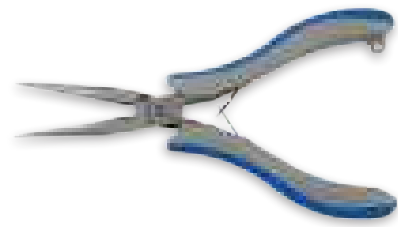
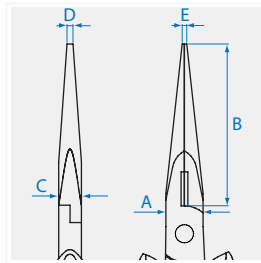
6317-06

 Long nose pliers





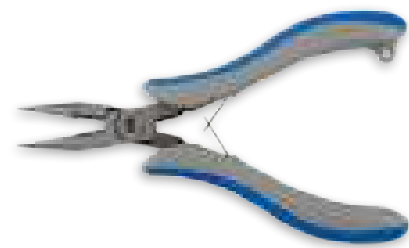
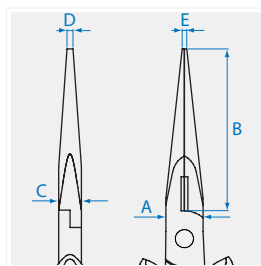

KT NO.	Overall length inch	mm	Cutting capacities  ∅ mm  ∅ mm		A mm	B mm	C mm	D mm	E mm		
6317-06	6	157	2.0	1.6	11.6	50	7.5	2	2	84	6 / 120

6377-55

 Half-round nose pliers





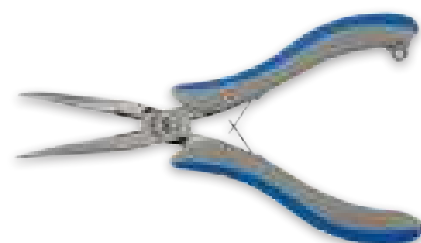
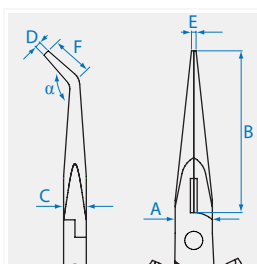

KT NO.	Overall length inch	mm	Cutting capacities  ∅ mm  ∅ mm		A mm	B mm	C mm	D mm	E mm		
6377-55	5-1/2	138	2.0	1.6	11.3	30	7.5	1.5	1.5	97	6 / 120

6337-06

 Bent nose pliers



KT NO.	Overall length inch	mm	Cutting capacities  ∅ mm  ∅ mm		α	A mm	B mm	C mm	D mm	E mm	F mm		
6337-06	6	154	2.0	1.6	40°	11.3	50	7.5	2	2.5	14	84	6 / 120



Precision Pliers

6347-05

8 Round-nose pliers

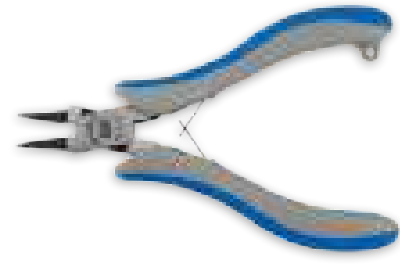
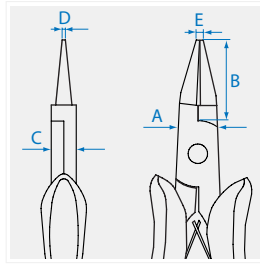

KT NO.	Overall length		A mm	B mm	C mm	D mm	E mm	Scales	Pkg/Box
	inch	mm							
6347-05	5	128	11.4	24.9	7.5	1	2.14	74	6 / 120

63A7-05

Round-nose pliers

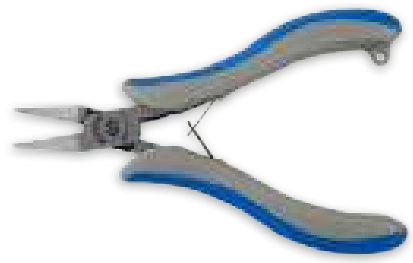
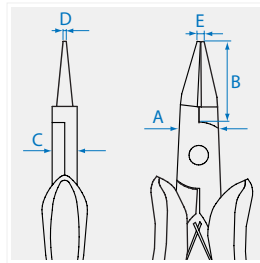
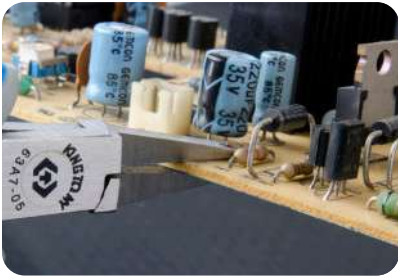

KT NO.	Overall length		A mm	B mm	C mm	D mm	E mm	Scales	Pkg/Box
	inch	mm							
63A7-05	5	128	11.5	24.7	7.5	3.3	1.8	75	6 / 120

63B7-05

Round-nose pliers

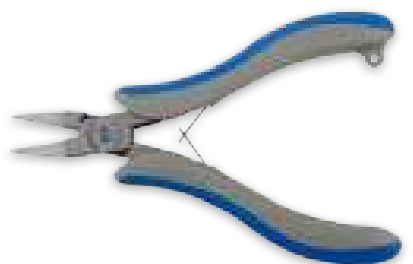
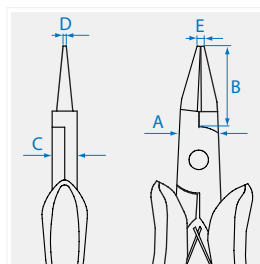

KT NO.	Overall length		A mm	B mm	C mm	D mm	E mm	Scales	Pkg/Box
	inch	mm							
63B7-05	5	128	11.5	24.7	7.5	1.3	1.8	74	6 / 120



Precision Screwdriver

- Shank material - SNCM - V alloy steel
- Grip material - PP
- Finishing - chrome plated with black tip

1431



- Phillips head, round shank
- DIN ISO 8764

KT NO.	⊕ No.	∅ mm	 mm		
14313015	PH000	1.5	40	7	10 / 320
14312015	PH00	2.0	40	7	10 / 320
14311015	PH0	3.0	40	13	10 / 100
14311115	PH1	4.0	40	16	10 / 100
14313003	PH000	1.5	75	8	10 / 320
14312003	PH00	2.0	75	8	10 / 320
14311003	PH0	3.0	75	14	10 / 100
14311103	PH1	4.0	75	18	10 / 100



1432



- Slotted head, round shank
- Metric size
- DIN 5263

KT NO.	 mm	 mm	 mm	∅ mm		
14320615	0.6	0.15	40	3.0	9	10 / 320
14320815	0.8	0.19	40	3.0	9	10 / 320
14321015	1.0	0.20	40	3.0	9	10 / 320
14321515	1.5	0.23	40	3.0	10	10 / 320
14321815	1.8	0.30	40	3.0	10	10 / 320
14322015	2.0	0.40	40	2.0	11	10 / 100
14322515	2.5	0.40	40	2.5	12	10 / 100
14323015	3.0	0.50	40	3.0	13	10 / 100
14323515	3.5	0.60	40	3.5	14	10 / 100
14324015	4.0	0.80	40	4.0	16	10 / 100
14321003	1.0	0.20	75	3.0	11	10 / 320
14321503	1.5	0.23	75	3.0	11	10 / 320
14321803	1.8	0.30	75	3.0	11	10 / 320
14322003	2.0	0.40	75	2.0	11	10 / 100
14322503	2.5	0.40	75	2.5	13	10 / 100
14323003	3.0	0.50	75	3.0	15	10 / 100
14323503	3.5	0.60	75	3.5	16	10 / 100
14324003	4.0	0.80	75	4.0	18	10 / 100



1433



- For torx head, round shank

KT NO.	⊛ Size	∅ mm	 mm		
14330415	T4	3	40	10	10 / 320
14330515	T5	3	40	10	10 / 320
14330615	T6	3	40	10	10 / 100
14330715	T7	3	40	10	10 / 100
14330815	T8	3	40	10	10 / 320
14330902	T9	4	50	16	10 / 100
14331002	T10	4	50	16	10 / 100
14331502	T15	4	50	16	10 / 100
14332002	T20	4	50	16	10 / 100
14330403	T4	3	75	11	10 / 320
14330503	T5	3	75	11	10 / 320
14330603	T6	3	75	11	10 / 320
14330703	T7	3	75	11	10 / 320
14330803	T8	3	75	11	10 / 320
14330903	T9	4	75	18	10 / 100
14331003	T10	4	75	18	10 / 100
14331503	T15	4	75	18	10 / 100
14332003	T20	4	75	18	10 / 100



Precision Screwdriver & Set

91230



- Screwdriver handle for interchangeable blades 2431, 2433
- Handle material - polypropylene (PP)



KT NO.	mm		
91230	100	12	10 / 100

2433



- Combination type
- Torx head, hexagonal shank
- Blade material - SNCM - V alloy steel
- Finishing - chrome plated with black tip



KT NO.	Size	mm	mm		
24330610	T6 x T10	4	120	11	20 / 200
24330715	T7 x T15	4	120	11	20 / 200
24330820	T8 x T20	4	120	11	20 / 200
24330915	T9 x T15	4	120	11	20 / 200

2431



- Combination type
- Phillips / Slotted head, hexagonal shank
- Blade material - SNCM - V alloy steel
- Finishing - chrome plated with black tip



KT NO.	No.	mm	mm	mm	mm		
24312020	PH00	2.0	0.30	4	120	11	20 / 200
24311030	PH0	3.0	0.50	4	120	11	20 / 200
24311140	PH1	4.0	0.60	4	120	11	20 / 200

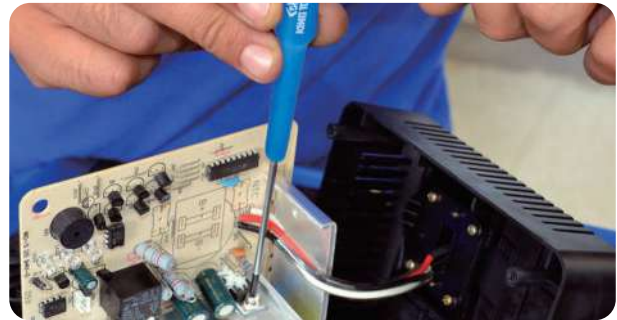

KT NO.	PC.	Contents		
32218MR	8	1.0 x 75, 1.5 x 75, 1.8 x 75, 2.0 x 75, 2.5 x 75, 3.0 x 75, 3.5 x 75, 4.0 x 75 1432	0.32	1 / 30
32209MR	9	0.8 x 40, 1.0 x 40, 1.5 x 40, 1.8 x 40, 2.0 x 40, 2.5 x 40, 3.0 x 40, 3.5 x 40, 4.0 x 40 1432	0.26	1 / 30
32108MR	8	PH000 x 40, PH00 x 40, PH0 x 40, PH1 x 40 1431	0.29	1 / 30
		1.5 x 40, 2.0 x 40, 2.5 x 40, 3.0 x 40 1432		
32118MR	8	PH000 x 75, PH.00 x 75, PH0 x 75, PH1 x 75 1431	0.36	1 / 30
		1.5 x 75, 2.0 x 75, 2.5 x 75, 3.0 x 75 1432		
32309PR	9	T4 x 40, T5 x 40, T6 x 40, T7 x 40, T8 x 40, T9 x 50, T10 x 50, T15 x 50, T20 x 50 1433	0.26	1 / 30
32607MR	8	91230	0.22	1 / 30
		PH00 x 2.0, PH0 x 3.0, PH1 x 4.0 2431		
		T6 x T10, T7 x T15, T8 x T20, T9 x T15 2433		



Precision Screwdriver Set

31419MR

- Precision screwdriver set

KT NO.	Contents	Each Q'ty
31419MR	⊕ 1431 PH000 x 40, PH00 x 40, PH0 x 40, PH1 x 40	6
	⊖ 1432 0.6 x 40, 0.8 x 40, 1.0 x 40, 1.5 x 40, 1.8 x 40, 2.0 x 40, 2.5 x 40, 3.0 x 40, 3.5 x 40, 4.0 x 40	
	⊗ 1433 T4 x 40, T5 x 40, T6 x 40, T7 x 40, T8 x 40	



114 PC.

Screwdriver shelf size (mm) : 383 x 136 x 130

Packing NO.	Spec.	Kg	CUFT
31419MR-A	87107	0.86	0.47
31419MR-D	114 PC. content	1.17	0.14

Soldering Iron

6BC141A

- 220V~240V, 20W / 40W
- For electrical and stained glass work
- Lightweight handle
- Replaceable tip

KT NO.	Voltage V	Rating W	⚖️	📦	
6BC141A	220-240	20 / 40	204	25 / 50	
6BC141-1	Soldering iron tip				
KT NO.	Rating W	∅ mm	Overall length	⚖️	📦
6BC141-1	20/40	6	81	17	10 / 100



6BC23

30W

6BC26

60W

- 110V~240V, 30W, 40W, 60W, 100W
- For electrical and stained glass work

KT NO.	Voltage V	Rating W	⚖️	📦
6BC23A	220-240	30	160	54
6BC23B	220-240	30	125	54
6BC23F	110-120	30	125	54
6BC24A	220-240	40	125	54
6BC24B	220-240	40	125	54
6BC24C	220-240	40	196	32
6BC24F	110-120	40	125	54
6BC26A	220-240	60	166	54
6BC26B	220-240	60	166	54
6BC26C	220-240	60	216	32
6BC26F	110-120	60	166	54
6BC210A	220-240	100	210	20
6BC210B	220-240	100	210	20
6BC210C	220-240	100	330	20
6BC210D	220-240	100	288	20
6BC210F	110-120	100	210	20

6BC24

40W

6BC210

100W



- Lightweight handle
- Replaceable tip
- No CE certification



Soldering Iron Tip (Conical Type)

6BC23-1

- Copper-based iron tips are manufactured using patented process which produces a uniform iron and chrome plating thickness

KT NO.	Rating W	∅ mm		
6BC23-1	30 / 40	4	13	100 / 4200
6BC26-1	60	6	16	100 / 1600
6BC26-3	60	6	16	100 / 1600

6BC26-1

6BC26-3

- All tips are pre-tinned

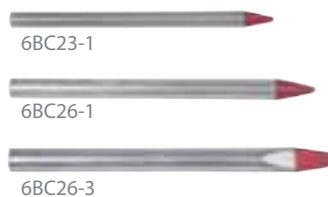











Gas Soldering Iron Set

6BC3007

- Gas soldering iron set with four tips, reflector and desolder wire
- Power range: 30W-150W
- Soldering temperature: 400°C~450°C (750°F~840°F)
- Torch temperature: 1300°C (2400°F)
- Fuel capacity: 20ml
- Tank fuel for 90 minutes operation
- Ready to use 45 seconds after ignition



8 PC.

KT NO.	Contents	 0.45	
6BC372		Gas soldering iron 257mm	20
6BC372-1		Conical	
6BC372-2		2.5mm round	
6BC372-3		3.5mm chisel	
6BC372-4		4.5mm angle	
6BC372-5		Reflector	
6BF21-17		Desolder wire / Sn 99.3%, Cu 0.7%	
		Foam	



Desolder Wire

6BF11-17

- 40% lead and 60% tin



KT NO.	Size mm		
6BF11-17	1.0	17	20 / 480

Desoldering Pump

6BD11

- One-hand operation
- ABS Body, teflon nozzle



KT NO.	Overall length mm		
6BD11	195	42	8 / 32

6BD22

- Anti-static solder desoldering pump
- Teflon suction head
- Aluminum body



- Turn down the body



- Clean

- Turn up the body



KT NO.	Overall length mm		
6BD22	197	85	50 / 100



Soldering Aid

6BE11-07

- Brush / Scraper :
- For removing flux residue and surplus solder

KT NO.	Overall length mm		
6BE11-07	175	15	1 / 200
6BE12-07	175	15	1 / 200
6BE16-07	180	15	1 / 200



6BE12-07

- Scraper / Curved Probe :
- For component and lead extraction

6BE16-07

- Pointed / Slotted Probe :
- Fits wire up to 22AWG
- For wrapping and unwrapping etc





Straight Fine Point Tweezers

6AF11-125

- Stainless steel with straight fine point
- Used for soldering integrated circuit chip, installing or replacing components
- It's suitable for doing precise repairing work



KT NO.	Overall length mm		
6AF11-125	124	16	50 / 800

Reverse Action Tweezers

6AF21-165

- Stainless steel with tapered tips and flat points
- For holding small parts when soldering or spraying



KT NO.	Overall length mm		
6AF21-165	172	29	30 / 480

Mini Soldering Iron Stand

6BC100

- Lightweight and high temperature bakelite resistance
- Mini size, easy to take
- Used for holding solder iron

 12  12 / 240



Soldering Iron Stand with Sponge

6BC200

- Suitable for most pencil type soldering irons
- Convenient for easy storage
- Sponge for tip cleaning
- Double spiral spring construction prevents the hot soldering iron from accidentally burning the surface of other objects when it is inserted into the stand

 187  4 / 24



Punch Down Tool

6AH

- For setting wire into terminal blocks or cut off wire end after terminated
- Blade : 66 & 110/88 & Krone type

KT NO.	Type	Overall length				
		inch	mm			
6AH11	110/88	6-3/4	170	140	20	80
6AH12	KRONE	6-3/4	170	140	20	80
6AH13	66	6-3/4	170	140	20	80
6AH14	66 & 110/88	6-3/4	170	140	20	80

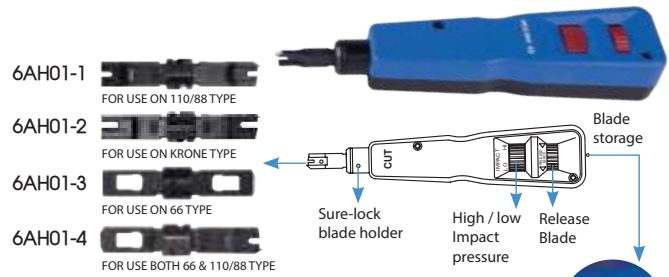

PVC Electrical Insulation Tape

6AG11-20



KT NO.	Width mm			
6AG11-20	18	52	1	250

Electronic Tool Set

- To repair electronic equipment...etc.

90217PQ



90217PQ01

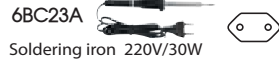

90217PQ03

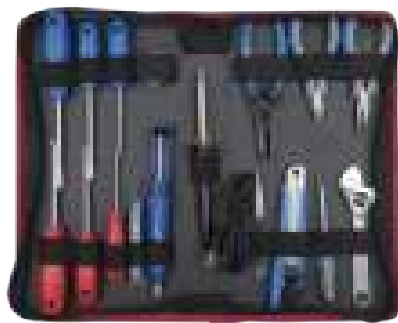

17 PC.

Contents				
	1412	1.26	1	8
	3 x 75, 5.5 x 100, 6.5 x 100			
	1411			
	PH0 x 75, PH1 x 100, PH2 x 100			
	6207-05			
	6377-55			
	6741-06			
	3611-06R			
	6BC23			
	6BC100			
	6BF11-17			
	6BD11			
	6AF11-125			
	6CB02			
	7976-65			

Electrician Tool Box Set

97121PQ

- For electrician equipment

21 PC.















87407
Overall size :
445 x 240 x 206 mm

Contents				
	1471	4.9	1	0.79
	VDE PH0 x 75, PH1 x 100, PH2 x 100, PH3 x 150			
	1472			
	VDE 3 x 75, 4 x 100, 5.5 x 125, 6.5 x 150, 8 x 175			
	6116-07A			
	VDE 7-1/2"			
	6146-08A			
	VDE 8-1/4"			
	6216-06A			
	VDE 6-1/2"			
	6318-08A			
	VDE 8-1/4"			
	6516-10A			
	VDE 10"			
	6716-06A			
	VDE 6-1/4"			
	6214-45			
	4-1/2"			
	6334-05			
	5"			
	6721-10			
	6751-44			
	6AB12-55			
	7932-04			

Electrician Tool Bag Set

91333MQ

- For electrician equipment

Contents		kg	6.02	1
⊕	 1421	PH1 x 80, PH2 x 100		
⊖	 1422	5 x 75, 5 x 100, 6.5 x 100, 6.5 x 150		
⊕	 1471	VDE PH2 x 100		
⊖	 1472	VDE 6.5 x 150		
	 6116-07A	VDE 7-1/2"		
	 6216-06A	VDE 6-1/2"		
	 6318-08A	VDE 8-1/4"		
	 6716-06A	VDE 6-1/4"		
	 20109MR	1.5, 2, 2.5, 3, 4, 5, 6, 8, 10		
	 20129SR	1/16, 3/32, 1/8, 5/32, 3/16, 1/4, 5/16, 3/8, 5/64		
	 3611-08R	200mm		
	 79093-05C	5M/16FT 19mm		
	 7971-07	165mm		

























33 PC.

87711C
Overall size :
510 x 255 x 345 mm / 39 inner pockets

91038MY01

- For electronic & electrician equipment...etc

















Contents		kg	3.13	1
⊕	 1421	PH0 x 60, PH1 x 80, PH2 x 100		
⊖	 1422	3 x 75, 5 x 75, 6.5 x 100		
	 6207-05	 6377-55	 6AB12-55	
	 6BF11-17	 6BD11	 6313-06	
	 7976-65	 6AF11-125	 6732-09	
	 6BC24A 220V / 40W	 87137	 6BC200	 6AG11-20
	 6BE11-07	 6BE12-07	 6BE16-07	
	 9DM1361	 1036ZQ	 ST20219MY1	
	 87721B			



38 PC.

87721B
Overall size : 360 x 200 x 260 mm



 Lit when in DC mode measurement	 Lit when in diode check	  Unit for voltage measurement
 Lit when in AC mode measurement	 Data hold indication	 Numeral data display
 Negative polarity indicator-lit when the polarity is negative	 Lit when the battery is low	 Lit when in transistor hFE check
 Auto range indicator	   Unit for resistance measurement	   Unit for current measurement
 Lit when in continuity check		

LCD DISPLAY















SELECT KEY

DATA HOLD KEY

**INPUT TERMINAL 10A
USAGE ONLY**

- The Max. protective fuse for μA , μA , mA , mA is 0.5A/250V
- The Max. protective fuse for $10A$, $10A$ is 15A/250V

POWER & FUNCTION SWITCH

 AC voltage measurement	 AC/DC current measurement in 10 amperes	 Turn off the power
 DC voltage measurement	 Transistor in NPN hFE measurement	 Transistor in PNP hFE measurement
 AC/DC current measurement in micro-amperes	 LED test	  
 AC/DC current measurement in milli-amperes	 AC or DC measurement	Resistance measurement / Diode test / Continuity check

Digital Multimeter

9DM1361

- Date hold, auto range, auto power off selection, auto power off cancellation
- Unit & function indication, Maximum reading value 1999 digits. Negative polarity indicator (no indication is given for positive polarity)
- Low power consumption
- Fuse with : 500mA / 600V & 10A / 600V
- AAA battery x 2 PC. included
- CE approval IEC61010-1 (2010), CAT.II 600V, CAT.III 300V



Specification	
DC Voltages (0.1mV ~ 1V)	200mV / 2V / 20V / 200V / 600V
AC Voltages (0.001V ~ 1V)	2V / 20V / 200V / 600V
DC Ampere (0.1uA ~ 0.01A)	200uA / 2000uA / 20mA / 2A / 10A
AC Ampere (0.1uA ~ 0.01A)	200uA / 2000uA / 20mA / 2A / 10A
Resistance (0.1Ω ~ 0.01MΩ)	200Ω / 2kΩ / 20kΩ / 200kΩ / 2MΩ / 20MΩ
Continuity check	Yes
Diode test	Yes
hFE(NPN, PNP)	Yes
LED check	Yes
Low battery indicator	Yes
LCD Display	3 1/2 digits 2000 counts
Sampling rate	3 times / sec

KT NO.	Size (mm)	⚖️	📦
	L x W x H		
9DM1361	138 x 70 x 32	85	10 / 60



Digital Multimeter

9DM1381

- Pocket size with flip cover design
- Approx. 4300 counts LCD display
- Auto range, auto power off selection
- Low power consumption
- LR44 battery x 2 PC. included
- CE approval EN61010-1, CAT.II 600V, CAT.III 300V
- Attachable test leads, easy operation



Specification	
DC Voltages (0.1mV ~ 1V)	400mV / 4V / 40V / 400V / 600V
AC Voltages (0.001V ~ 1V)	4V / 40V / 400V / 600V
Resistance (0.1Ω ~ 0.01MΩ)	400Ω / 4kΩ / 40kΩ / 400kΩ / 4MΩ / 40MΩ
Continuity check	Yes
Diode test	Yes
Overload indicator	OL
Low battery indicator	Yes
Sampling rate	Approx. 2 times / sec

KT NO.	Size (mm)	⚖️	📦
	L x W x H		
9DM1381	117 x 76 x 18	121	20 / 80



Digital Clamp Meter

9DM2351

- Max clamp size : Ø 30mm
- Unit & function indication, maximum reading value 1999 digits
- Negative polarity indicator (no indication is given for positive polarity)
- Auto power off selection approx. 15 minutes
- Low power consumption
- AAA battery x 2 PC. included
- CE approval IEC 61010-1, IEC 61010-2-032
CAT.III 600V Pollution Degree 2
- Attachable test leads, easy operation

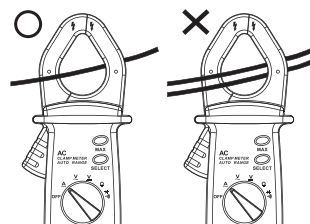

Specification	
AC Ampere (0.1A - 1A)	200A / 600A
AC Voltages (0.001V - 1V)	2V / 20V / 200V / 600V
DC Voltages (0.1mV - 1V)	200mV / 2V / 20V / 200V / 600V
Resistance (0.1Ω - 0.01MΩ)	200Ω / 2kΩ / 20kΩ / 200kΩ / 2MΩ / 20MΩ
Continuity check	Yes
Diode test	Yes
Low battery indicator	Yes
LCD Display	3 1/2 digits 1999 counts
Sampling rate	3 times / Sec.
Overload indicator	OL

KT NO.	Size (mm) L x W x H		
9DM2351	189 x 71 x 37	354	5 / 40

AC Non-contact Voltage Tester

6CB31

- Voltage ranges : 80 to 1000V AC.(50~60Hz)
- Application :
AC voltage in outlets, lighting, circuit breakers, wires and cables etc..
- Adjustable sensitivity voltage detection
- Visible LED light voltage indicator in tip
(Green light is high gear, red light is low gear)
- AAA battery x 2 PC. included
- Standard category :
EN 61000-6-3 / EN 61000-6-1 CAT III



KT NO.	Overall size (mm) L x W x H		
6CB31	160 x 20 x 24	72	10 / 100

Measurement level

The input voltage should not exceed the maximum value.

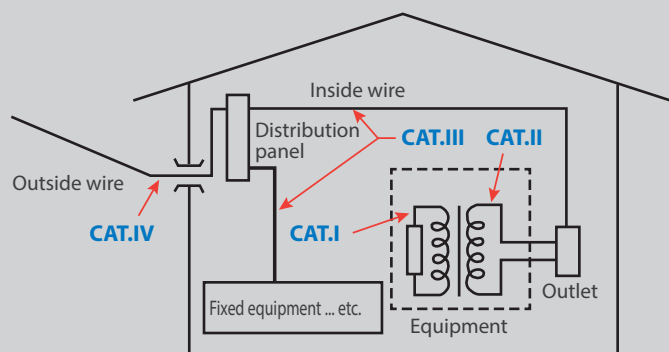

Measurement level	Description	Example
CAT.I	Measurement directly connected to the power supply circuit board	The secondary of the transformer measured
CAT.II	Measurement board directly connected to the low voltage devices	Equipment, portable devices
CAT.III	Equipment within the building	Distribution panels, circuit breakers
CAT.IV	Sources of all low voltage installations	Overhead lines, cable facilities



9 in 1 Multifunctional Wire Stripper

6CB41

- Non-contact voltage detection 80 - 1000V, 3 minutes auto power off
- Application: AC voltage in outlets, lighting, circuit breakers, wires and cables etc
- Illumination: COB LED
- Magnetic pads which can be useful for holding small components like nuts and bolts
- Screwdriver No. PH2 x1
- Battery: 3V (AAA 1.5V x2) Included
- Standard category: CAT IV 1000,
EN 61010-1 : 2010/A1 : 2019, EN 62471 : 2008,
EN 61326-1 : 2013, EN 61326-2-2 : 2013



- Magnetic
- Lock
- Cut



- Stripper(romex cable type NM-B)
- Stripper
- Stripper



- Volt tester
- Measurement
- Screwdriver (Use 65mm-70mm)



- Light switch
- Test switch

KT NO.	Wire stripper	Stripping romex cable	Stripping round cable Ø mm	Wire cutter Ø mm		
6CB41	mm ² -0.5, 0.8, 1.3, 2.0, 3.3, 5.0, 8.0 AWG-20, 18, 16, 14, 12, 10, 8	12~2	8~10	7	220	1 / 50



Infrared Thermometer

9DN12

- Not necessary to contact with the object
- IR point can be displayed clearly
- °C and °F interchangeable functions
- Selection of different materials
- Dark screen backlight test board functions
- 15 seconds automatically turn off the screen
- 9V battery x 1 PC. (included)

Technical data

Temperature range	-30~550°C (-22~1022°F)
Operating temperature	0~50°C
Resolution	0.1°C / 0.1°F
Accuracy	±2.5% OR 3°C
Emissivity	Selectable (0.85 / 0.90 / 0.95)
Distance to spot ratio	12 : 1
Auto power off	15 seconds
Laser pointer	Class 2 Laser < 1 mW

KT NO.	Overall Size (mm)			
	L x W x H			
9DN12	193 x 47 x 126		313	5 / 20



Testing Screwdriver

6CB02

- Testing range : 100~250V
- CE approval
- Don't use the testing screwdriver as screwdriver
- Neon indicator



KT NO.					Testing range		
	mm	mm					
6CB02	3	0.6	65.5	140	100~250V	15	12 / 288

Digital Voltage Tester

6CB21

- Self-Diagnostic test
- Built-in LED flashlight
- LCD Display
- Protection IP64
- AAA 1.5V x 2 PC.
- Standard category :
EN 61243-3 / IEC 61243-3
EN 61010-1 / IEC 61010-1
CAT.III 690V / CAT.IV 600V

KT NO.	Overall Size (mm)			
	L x W x H			
6CB21	255 x 66 x 30		250	5 / 20

Specification

DC Voltage Test	12, 24, 50, 120, 230, 400, 690V
Polarity indication	Yes
AC Voltage Test	12, 24, 50, 120, 230, 400, 690V
Phase rotation test	Yes
High voltage indication	≥ 50V
Frequency range	0-70Hz
Continuity test	0~550KΩ
Operation condition	-10~55°C





WIRE & CABLE TOOLS

ELECTRONIC & ELECTRICAL



Electrician Scissors

6AB13-06

- High cutting performance by low cutting force



• 38mm² wire



Ergonomic design, handles made of high compressive strength and non-slip nylon fiber + TPV
Special handle design, also suitable for the left-hander

Blades made of AUS-8, serrated on the edge can prevent objects from slip away, soft cable, up to dia 38mm², insulation materials, electrical tape cable tie

KT NO.	Overall length		Cutting length mm	Cutting capacity AWG	Cutting capacity mm ²	Scales	Boxes
	inch	mm					
6AB13-06	6	150	26	2	38	114	12 / 72

6AB21-65

- Curved mouth cable cutter
- Safety blade locking system

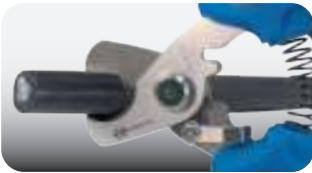

KT NO.	Overall length		Cutting length mm	Cutting capacity mm ²	Scales	Boxes
	inch	mm				
6AB21-65	6-1/2	158	22	10	156	12 / 72

Multi-purpose Scissors

6AB12-55

- Stainless steel with serrated edges
- Grip material - PP + TPR



KT NO.	Overall length mm	Overall length (mm)	Cutting capacities (mm ²)							Scales	Boxes
			Electric cable	Cardboard	Rubber	Leather	Rolled steel	Copper (soft)	Aluminum		
6AB12-55	145	55	10	10	10	10	0.5	0.5	0.5	94	12 / 72

6AB31-75

- Even mouth cable cutter
- Safety blade locking system



KT NO.	Overall length		Cutting capacity mm	AWG	mm ²	Cutting capacity (mm ²)			Scales	Boxes
	inch	mm				Leather	Copper(soft)	Aluminum		
6AB31-75	7-1/2	185	52	16-12	1.5-4.0	2.0	0.5	0.5	160	12 / 72

- Cut cable, cardboard, rubber, leather, rolled steel, copper (soft), aluminum, carpet, branch and so on.



5 in 1 Multi-functional Electrician Scissors

6AB14-06

- Professional scissors with special steel frame for high resistance and durability
- High hardness blades and anti-slip serrated edge for making precise cuts
- Light and strong handles are made from impact-resistant plastic material
- Ergonomically-designed handles are suitable for a comfortable grip
- PP+TPR handle material
- The blade is made of 4034 stainless steel



• Crimping terminal of cable

• Scraping

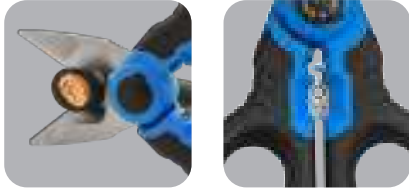

• Welding cable 100mm²

• Wire stripper 1.5-4mm²



KT NO.	Overall length		Cutting length mm	Cutting capacity AWG	Cutting capacity mm ²	Wire stripper		Pin terminal insulated/ Non-insulated terminal crimping		Scales	Boxes
	inch	mm				mm	mm ²	mm ²	AWG		
6AB14-06	6-3/8	161	24	1/0	50	14, 12	1.5, 2.5	14	2.5	193	12 / 48

6AB14-65

- Professional scissors with special steel frame for high resistance and durability
- High hardness blades and anti-slip serrated edge for making precise cuts
- Light and strong handles are made from impact-resistant plastic material
- Ergonomically-designed handles are suitable for a comfortable grip
- PP+TPR handle material
- The blade is made of 4034 stainless steel

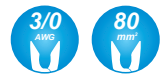

• Wire stripper 1.5-4mm²

• Crimping terminal of cable

• Crimping terminal of cable



• Welding cable 80mm²

• Scraping



KT NO.	Overall length		Cutting length mm	Cutting capacity AWG	Cutting capacity mm ²	Wire stripper		Pin terminal insulated/ Non-insulated terminal crimping		Scales	Boxes
	inch	mm				mm	mm ²	mm ²	AWG		
6AB14-65	6-3/4	170	21	3/0	80	16, 14, 12	1.5, 2.5, 4	14	2.5	228	12 / 48



Multi-purpose Scissors

6AB33-95

- Ergonomically-designed handles are comfortable and durable during usage
- For cutting soft materials such as tin sheets, plastics, CD, cards and papers...etc
- The stainless steel blade and the curve-blade design makes it steady and saves strength while cutting
- The big angle design between blades and the handles of the scissors makes it so your hand never touches any object while operating
- Designed to conveniently adjust blades
- The blade is made of 420J2 stainless steel material
- PP+TPR handle material

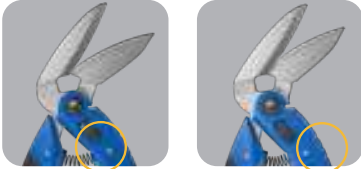

• Large angle of blades • Small angle of blades



• Big angle design between blades and the handles of the scissors



• Iron wire cutter

KT NO.	Overall length		Cutting length mm	Wire cutting Aluminum / Copper mm	Cutting capacities (mm ²)				312	6 / 48
	inch	mm			Cardboard / Carpet / Copper / Aluminium (soft)					
6AB33-95	9-3/4	246	73	2.5	10	5	0.5	0.6		

Retractable Safety Cutter

7946-07

- Multifunctional safety cutters with trapezium blades 60x18 mm premium quality robust and resistant
- Upper slider for blade extraction with automatic retraction
- Container with 2 replacement blades integrated in the handle
- Integrated device for cutting nylon threads and films
- Structure in zinc alloy, anti-slip ergonomic grip handle in TPR Soft-Grip
- High quality blades in carbon steel SK5 extremely sharp and long duration



• Auto return butto • Auto lock button • 2 blades in storage • Blade replace button

7945-07P01
(62mm, 10 PC.)

KT NO.	L mm	312	6 / 72
7946-07	180	200	12 / 72

7946-07-S

Paper display stand size(mm) :
243 x 199 x 217 (0.37 CUFT)

KT NO.	Contents	312	6 / 72
7946-07-S	 x 12 PC.	2.75	1 / 4



12
PC.



Cable Cutting Pliers

6141C

- Polished head
- For cutting copper and aluminum cables, single and multiple wire

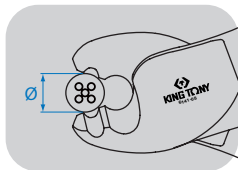

KT NO.	Overall length		Cutting capacity		Kg	Box / Carton
	Inch	mm	DIN(mm ²)	AWG		
6141-06C	6	160	33	2	169	6 / 120
6141-08C	8-3/8	212	67	2 / 0	282	6 / 60

Cable Cutter

6AD

- Cable cutter for cutting copper and aluminum cable



• Can be use with : 67B3-55 439 / 6AC51 444

KT NO.	Overall length mm	Cutting capacity		Kg	Box / Carton
		DIN(mm ²)	AWG(MCM)		
6AD17-150	435	150	300	1.34	1 / 20
6AD23-400	595	400	800	1.84	1 / 10

Ratcheting Cable Cutter

6AD10-325

- Cut soft copper, aluminum and multiple conductor cable to 325mm² (600MCM)
- Cuts hard drawn copper to 200mm² (400MCM)

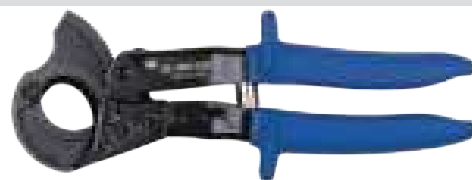

KT NO.	Overall length mm	Cutting capacity		Kg	Box / Carton
		mm ²	AWG(MCM)		
6AD10-325	255	325	600	613.2	10 / 30
6AD10-3P01	Spare cutting blade			58	1 / 100

6AD16-500

- Cut soft copper, aluminum and multiple conductor cable to 500mm² (1000MCM)



KT NO.	Overall length mm	Cutting capacity		Kg	Box / Carton
		mm ²	AWG(MCM)		
6AD16-500	400	500	1000	1.60	1 / 10



Electrician Knife

7932-04

- Electrician knife with wire stripper
- 1 blade with half-moon notch for stripping and vee for cutting



KT NO.	Blade length mm	Closed length mm	Overall length mm		
7932-04	85	110	196	75	10 / 180



7933-45

- Straight blade electrician knife



KT NO.	Blade length mm	Closed length mm	Overall length mm		
7933-45	85	120	205	111	10 / 180

Cable Stripping Knife

7935-08

- Blades are made from high tensile steel, allowing for excellent strength and performance
- Light and strong handles are made from impact-resistant plastic material
- Ergonomically-designed handles are suitable for comfortable and durable usage
- The Cable Stripping Knife has a protection sheath
- The protection sheath can also be used for assisting stripping wires
- The V-shaped groove can be used to position wires, and can prevent sliding while you peel wires
- Nylon handle
- The blade is made of 4034 stainless steel

KT NO.	L mm		
7935-08	204	109	12 / 72

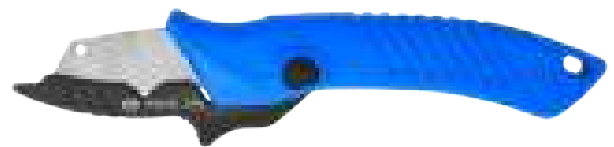

• Cable stripping



• Scraping



• Protection set locked

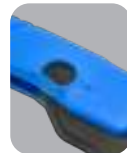

• Protection set unlocked

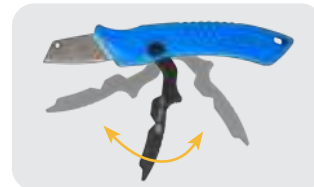

Folding Clasp Knife

7941-08

- Suitable for mechanics, outdoor and camping etc
- Blade fixator folded out
- Light and handy to use
- Stainless Blade with blacking coating
- With belt clip

KT NO.	L mm		
7941-08	210	166	8 / 48

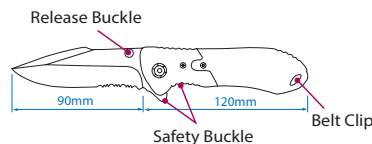

Utility Cutter

7971-07

- Automatically reloading snap-off blades
- Ergonomic soft ABS TPR handle
- Stainless steel blade guide
- Blade lock knob
- 4-blade cartridge(18mm)

KT NO.	L mm		
7971-07	165	180	6 / 72



• 3 blades in storage



7978-07

- 3-blade cartridge with automatically reloading function
- Material : SK4 (HRC \geq 62)
- 0.5mm thickness and 18mm width

KT NO.	L mm		
7978-07	175	131	12 / 144



• Quickly remove blade & automatically reload function





• 3 blades in storage



7978-07-S

Paper display stand size(mm) :
172 x 1360 x 222mm (2.75CUFT)



KT NO.	Contents		
7978-07-S	 x 12 PC.	1.58	1 / 12



12 PC.

7977-07



- Heavy duty 18mm wide cutting knife with snap off blades
- Exceptional cutting performance with SK4 blade (HRC \geq 65)
- Provides sharper and more stable cutting with a high hardness cutting edge

KT NO.	L mm	N.W	G.W	CUFT		
7977-07	180	20	22	2.13	117	12 / 144
7977-07P02	-	10	12	1.06	9	200 / 2400



7977-07-S

Paper display stand size(mm) :
265 x 162 x 245 (0.37CUFT)

KT NO.	Contents		
7977-07-S	 x 12 PC.	2.23	4



12 PC.



Multi-purpose Wire Stripper

6751-44

- Wire stripper
- Wire cutter
- Cable stripper



Preparation blade

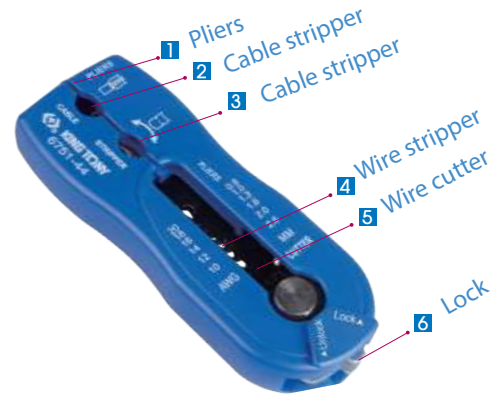

KT NO.	Wire stripper Ø mm	AWG	Cable stripper Ø mm	Wire cutter Ø mm			
6751-44	0.8-2.6	20-10	6-10	6	116	10 / 120	

Wire Stripper

6762-08



- Insulated terminal crimping



- Wire stripper



- Wire cutter

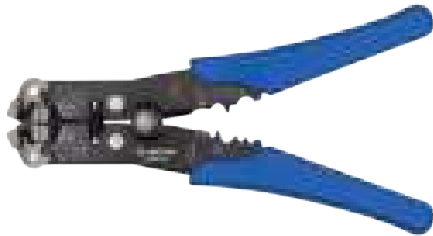

KT NO.	Wire stripper mm ²	AWG	Wire cutter Ø mm	Insulated terminal crimping mm ²	AWG			
6762-08	0.2-6	24-10	6	0.5-6	22-10	271	15 / 60	

67A1-07



KT NO.	Wire stripper mm ²	AWG	Wire cutter Ø mm			
67A1-07	0.05-3.5	30-12	5	209	12 / 60	

Wire Stripper Pliers

6761-07

- Aluminum body design for light weight
- Special design of strip length setting function for quickly operate
- SK5 knife



KT NO.	Wire stripper mm ²	Overall length mm			
6761-07	0.9, 1.25, 2, 3.5, 5.5	178	271	10 / 60	



Cable Stripper

6755-05

- UTP/STP, flat cable stripper & cutter
- Material : ABS

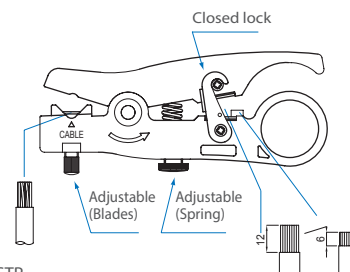

UTP/STP cable stripper	(\varnothing 2.6 ~ \varnothing 8.0)
Flat cable stripper / cutter	RJ-45 (12 mm), RJ-11/12 (6 mm)

UTP/STP
Cable stripper
(\varnothing 2.6 ~ \varnothing 8.0)

Flat cable
stripper / cutter
RJ-45 (12 mm)
RJ-11/12 (6 mm)

KT NO.	Overall length			
	inch	mm		
6755-05	5	127	72	20 / 120

Coax. Cable Stripper

6756-05

- 2-Blades model
- Material : ABS

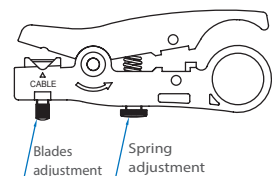

Stripper dimension "d"	6.4 mm
Stripper distance 2-Blades model	RG-174/58/59/62/6 3C/4C/5C (\varnothing 2.6 ~ \varnothing 8.0)

KT NO.	Overall length			
	inch	mm		
6756-05	5	127	68	20 / 120

Fiber Optic Stripper

67B1-06

- Three in one model performs all common fiber stripping functions
- Safety locking system for easy and steady stripping
- Ergonomic handle for comfort grip

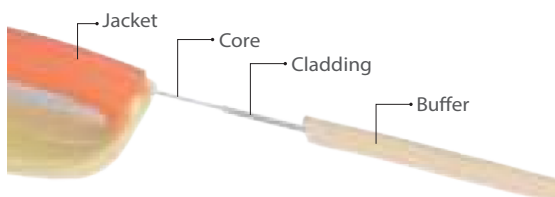

Safety locking system

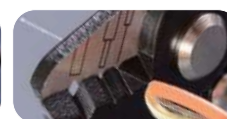

• To strip the 2.0-3.0 mm fiber jacketing

• 600-900 micron buffer layer stripping

• Strips the 250 micron cable down to the glass fiber without scratching or nicking glass fiber

KT NO.	Overall length		Stripping range				
	inch	mm	mm	μ m	μ m		
67B1-06	6	150	2.0-3.0	600-900	250	130	10 / 100



Multi-stripper

67B2-05

KT NO.	Overall length			
	inch	mm		
67B2-05	4-3/4	120	69	15 / 90

Stripping capacity

- Round cables between : 8-13mm
- Wire cable : 0.5 1.0 1.5 2.5 4.0 6.0mm²
- AWG : 20 18 16 14 12 10
- Coax.cable : RG-6 / RG-59

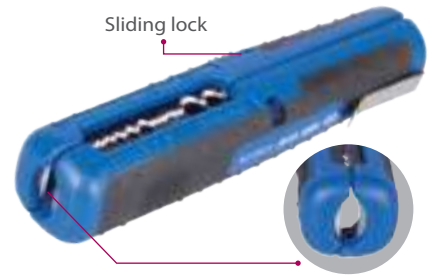

Cable Stripper

67B3-55

- Fast and safe stripping of round cable sheaths made of PVC or rubber from 6-45mm dia
- Adjustable knurled nut for max 6mm sheath

KT NO.	Cable stripper mm ²	Overall length			
		inch	mm		
67B3-55	6-45	5-1/2	140	170	10 / 100



• Can be use with : 6AC51  444 / 6AD  434



- Adjustable cutting depth



- Push cover



- Simple rotating the tool body



Stop



- Remove the cable sheaths without damage of the inner conductors



■ Crimp die profiles

Symbol		
		Phone plugs 6 pin
		Modular plugs 8 pin
		Insulated terminal connectors
		Non-Insulated terminal connectors
		Pin terminal, Insulated & Non-Insulated ferrules
		Non-Insulated terminal, Lug connectors

Symbol		
		CATV "F", BNC, COAX, and fiber optics connectors
		
		
		



Modular Crimping Tool

67F1-08

- For cutting / stripping / crimping
- 2 types of plugs in 1 tool
- Grip material - PP+TPR



• 6P • 8P

KT NO.	Overall length			
	inch	mm		
67F1-08	8	203	370	10 / 40

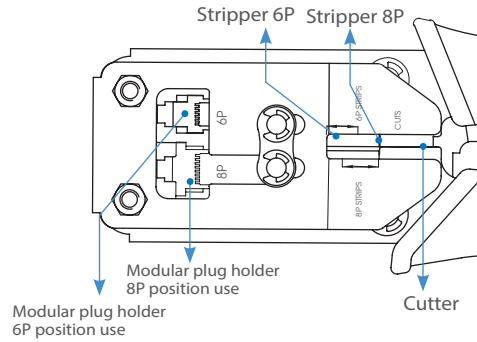

Interchangeable Ratchet Crimping Tool Set

42107GX

- Quick interchangeable ratchet function & easy to use
- Crimping jaws with heat treatment
- Blow case size (mm) : 282 x 176 x 52 (0.09 cuft)

1.16 1 / 10



7 PC.

Ratchet Crimping Tool Set

67G0005

- Blow case size (mm) : 240 x 70 x 50 (0.07 cuft)

1 1 / 16



5 PC.



Item No.	Replacement die set	Terminal size	Description	
6781POA		AWG 12-10 / 16-14 / 22-18 / 0.5-1.0 / 1.5-2.5 / 4-6 mm ²	Insulated Terminal	
6781POB		AWG 1.5 / 2.5 / 8 / 10 mm ²	Non-Insulated Terminal	
6781POC		AWG 0.5-1 / 1.5 / 2.5 / 4-6 mm ²	Open Barrel Terminal	
6781POD		AWG 0.5 / 0.75 / 1 / 1.5 / 2.5 / 4 mm ²	Insulated Core-end Terminal	
6781POF		AWG 6 / 8 / 10 / 16 mm ²	Insulated Huge Core-end Terminal	
6781POH		AWG 0.5 / 2.5 / 8-6 / 8-10 / 14 / 22 mm ²	Open Barrel & D-Sub, V.35 Connectors	
6781-85			Ratchet	

Item No.	Replacement die set	Terminal size	Description	
67GN-09	67GNP01	AWG 12 / 14 / 16 / 18 / 20 / 22 / 0.5 / 0.75 / 1.0 / 1.5 / 2.5 / 4.0 mm ²	PIN TERMINAL INSULATED OR NON-INSULATED FERRULES	
67GJP01		AWG 6 / 8 / 10 / 6 / 10 / 16 mm ²	PIN TERMINAL INSULATED OR NON-INSULATED FERRULES	
67GKP01		AWG 12-10 / 16-14 / 20-18 / 0.5-1.0 / 1.5-2.5 / 4-6 mm ²	INTER-LOCKING & NON-INSULATED	
67GLP01		AWG 12-10 / 8 / 16-14 / 20-18 / 1.5 / 2.5 / 6 / 10 mm ²	NON-INSULATED TERMINAL	
67GHP01		AWG 12-10 / 16-14 / 22-18 / 0.5-1.0 / 1.5-2.5 / 4-6 mm ²	FOR INSULATED TERMINAL	



Ratchet Crimping Tool









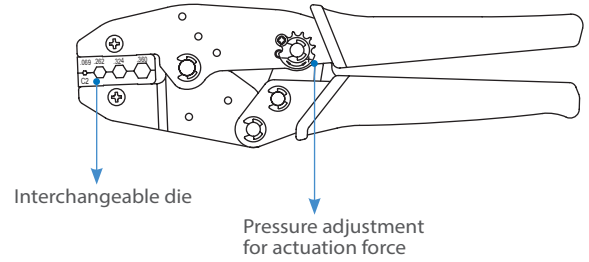







67G

- For crimping RG type cable
- CATV "F" connectors
- Interchangeable die



KT NO.	Overall length inch	mm		
67G	8.7	222	480	1 / 30



Item No.	Replacement die set	Terminal size	Description	
67G1-09	 67G1P01	.068" .262" .324" .360" (1.72 6.65 8.23 9.14 mm)	CATV "F" Connectors RG59, 6	
67GB-09	 67GBP01	.075" .100" .128" .429" (1.9 2.54 3.25 10.9 mm)	RG8, 9, 11, 174, 316 BELDEN 9913	
67GN-09	 67GNP01	AWG 12 / 14 / 16 / 18 / 20 / 22 0.5 / 0.75 / 1.0 / 1.5 / 2.5 / 4.0 mm ²	PIN TERMINAL INSULATED OR NON-INSULATED FERRULES	
67GJ-09	 67GJP01	AWG 6 / 8 / 10, 6 / 10 / 16 mm ²	PIN TERMINAL INSULATED OR NON-INSULATED FERRULES	
67GK-09	 67GKP01	AWG 12-10 / 16-14 / 22-18 0.5-1.0 / 1.5-2.5 / 4-6 mm ²	INTER-LOCKING & NON-INSULATED	
67GL-09	 67GLP01	AWG 12-10 / 8 / 16-14 / 20-18 1.5 / 2.5 / 6 / 10 mm ²	NON-INSULATED TERMINAL	
67GH-09	 67GHP01	AWG 12-10 / 16-14 / 22-18 0.5-1.0 / 1.5-2.5 / 4-6 mm ²	FOR INSULATED TERMINAL	
67GG-09	Unchangeable	AWG 12-10 / 16-14 / 22-18 0.5-1.0 / 1.5-2.5 / 4-6 mm ²	FOR INSULATED TERMINAL	



Crimping Tools

6721-10

- Wire cutter
- Crimps insulated terminals
- Bolt cutter
- Crimps non-insulated terminals (Open barrel)
- Wire stripper



FUNCTION:

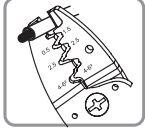

• Wire cutter

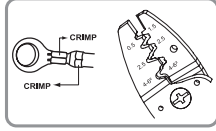

• Open barrel terminal crimping

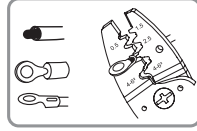

• Non-Insulated terminal Crimping

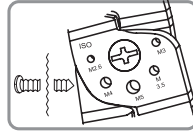

• Bolt-cutter

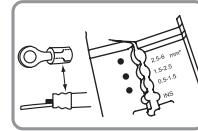

• Insulated terminal Crimping

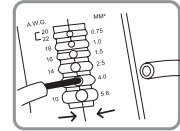

• Wire stripper

KT NO.	Wire cutter Ø mm ²	Insulated terminal crimping	Bolt-cutter	Non insulated terminal crimp	Open barrel terminal crimping	Wire stripper mm ²			
6721-10	6	0.5~6	M2.6~5	0.5~6	1.5~6	0.75~6.0	294	50	50

6732-09

- Wire cutter
- Crimps insulated terminals
- Bolt cutter
- Crimps non-insulated terminals (Ring)
- Wire stripper

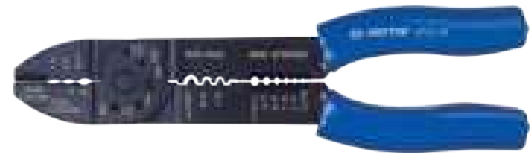

FUNCTION:

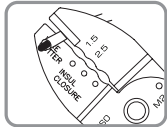

• Wire cutter

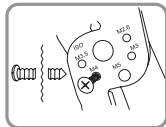

• Bolt-cutter

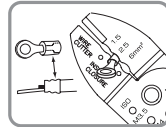

• Insulated terminal Crimping

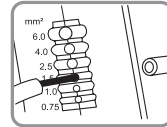

• Wire stripper

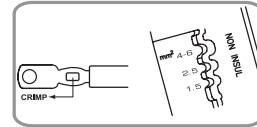

• Non-insulated ring terminal crimping

KT NO.	Wire cutter Ø mm ²	Insulated terminal crimping	Bolt-cutter	Non-insulated ring terminal crimping	Wire stripper mm ²			
6732-09	6	1.5~6	M2.6~5	1.5~6	0.75~6.0	261	24	72

6741-06

- Wire cutter
- Wire stripper

FUNCTION:

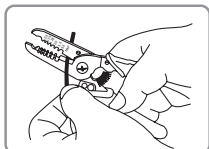

• Wire cutter

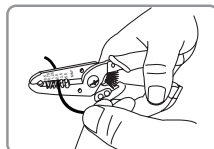

• Wire stripper

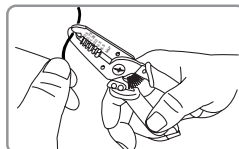

• Peel the electric wire's shell



KT NO.	Wire cutter Ø mm ²	Wire stripper mm ²			
6741-06	6	0.5~5.5	103	10	100





Heavy Duty Crimping Tool

6AC51-26

- For cable lugs from 10mm²-150mm² with non-ratchet screw adjustment



Crimping capacity

KT NO.	Overall length mm	 kg	 / 	Crimping capacity										
				AWG	8	6	4	2	1/0	2/0	3/0	4/0	300MCM	
6AC51-26	665	3.9	1 / 5	JIS(mm ²)	8	14	22	38	60	70	80	100	150	
				DIN(mm ²)	10	16	25	35	50	70	95	120	150	

6AC52-12

- Ratchet designed. For non-insulated terminals



KT NO.	Overall length		 kg	 / 
	inch	mm		
6AC52-12	12	300	520	6 / 24

Item No.	AWG	16	14	10	8	6
	JIS mm ²	1.25	2	5.5	8	14
	DIN mm ²	1.5	2.5	6	10	16

6AC52-12	•	•	•	•	•
----------	---	---	---	---	---



HAMMERS & STRIKING TOOLS



Hammer

Convert:
1g = 0.035 oz / 1g = 0.0022 lb

7811

- American style
- Forged and hardened steel
- Wood and metal wedge
- GGG-H86C

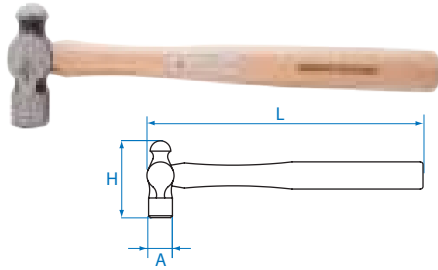

KT NO.	H.W g	A mm	H mm	L mm		
7811-08	245	25	80	300	391	6 / 60
7811-12	370	29	93	300	480	6 / 48
7811-16	485	32.5	103	353	651	6 / 36
7811-24	765	35.5	122	405	983	6 / 24
7811-32	925	40.5	125	405	1170	6 / 24
7811-40	1125	42.2	133	405	1344	6 / 12

7821

- 7821: German style
- 7821: Forged and hardened steel
- 7821: Wood and metal wedge
- 7821: DIN 1041
- 7823: Engineer's hammer
- 7823: DIN1041

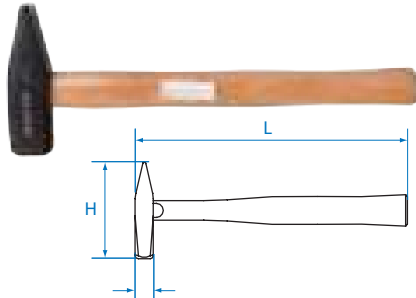

KT NO.	H.W g	A mm	H mm	L mm		
7821-30	371	23	103	300	395	12 / 48
7821-50	500	27	120.5	320	615	6 / 36
7821-80	800	33	130	350	990	6 / 24
7823-10	1000	36	135	360	1121	9 / 18
7823-15	1500	42	145	380	1666	6 / 12
7823-20	2000	47	155	400	2197	6 / 12

7822

- Riveting hammer
- NF E71-016

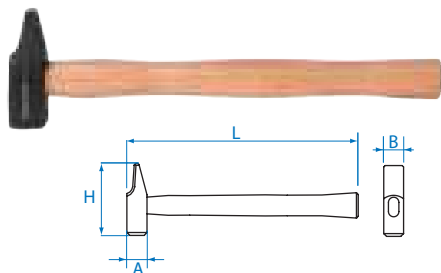

KT NO.	H.W g	A mm	B mm	H mm	L mm		
7822-30	400	30	26	95	300	463	10 / 40
7822-40	800	40	35	115	320	977	8 / 16
7822-45	1250	45	40	124	355	1267	8 / 16
7822-50	1600	50	44	135	382	1856	6 / 12

7833

- Lump hammer
- DIN 6475

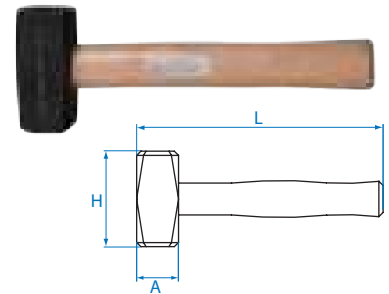

KT NO.	H.W g	A mm	H mm	L mm		
7833-10	1000	40	95	260	1066	7 / 14
7833-12	1250	43	100	260	1425	6 / 12
7833-15	1500	45	110	280	1642	6 / 12
7833-20	2000	50	120	300	2142	4 / 8

7834

- Sledge hammer
- Fiberglass handle

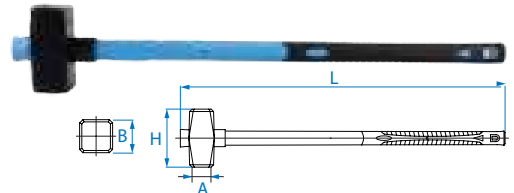

KT NO.	H.W g	A mm	B mm	H mm	L mm		
7834-50	5000	68	70	158	908	5850	1 / 2

7852

- Rubber hammer
- Fiberglass handle

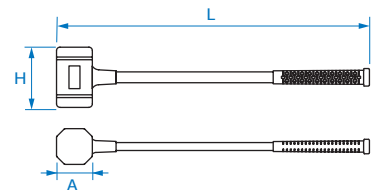

KT NO.	H.W g	A mm	H mm	L mm		
7852-23	1650	69.5	142	500	2062	4 / 8
7852-55	4500	104	198	910	5500	2 / 4

7861

- Fiberglass claw hammer

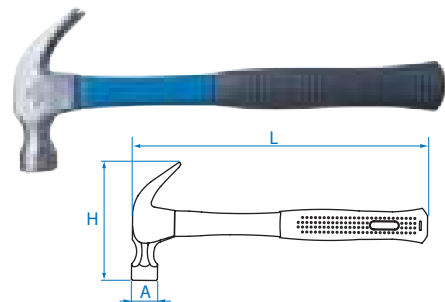

KT NO.	H.W g	A mm	H mm	L mm		
7861-08	225	24.8	106	275	374	10 / 40
7861-16	450	30.0	133	335	740	4 / 24
7861-20	565	31.0	144	340	830	4 / 24
7861-24	680	32.0	147	380	920	10 / 20

Hammer



CAUTION Please wear proper safety gear while working.

7848

- Rubber hammer
- Feature : used to lay basalt floors, tires and other materials which are vulnerable

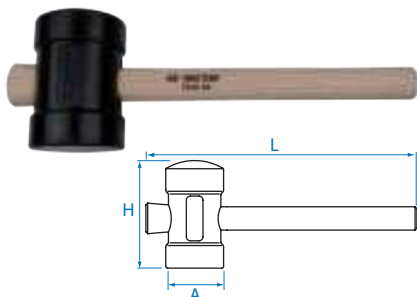

KT NO.	H.W g	A mm	H mm	L mm		
7848-60	523	64	119	330	628	6 / 12
7848-80	821	79	119	350	979	5 / 10

7851

- Dead blow hammer

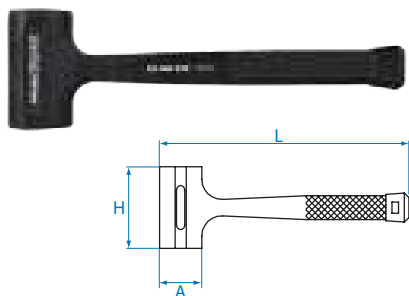

KT NO.	H.W g	A mm	H mm	L mm		
7851-08	227	44	81	272	572	6 / 24
7851-16	454	45	100	304	804	6 / 24
7851-24	680	49	100	322	942	6 / 24
7851-32	907	55	100	342	1059	6 / 24
7851-40	1134	58	110	342	1168	6 / 24
7851-48	1361	61	123	355	1321	6 / 12
7851-64	1814	68	136	368	1976	6 / 12

7842

- Soft face hammer
- Replaceable polyurethane face
- Helps minimize marring and surface damage

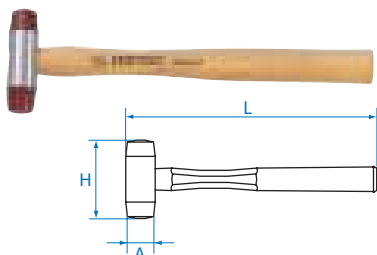

KT NO.	A mm	H mm	L mm		
7842-22	22	75	255	110	10 / 40
7842-28	28	85	295	165	10 / 40
7842-35	38	100	325	305	8 / 32
7842-45	45	112	335	420	8 / 32
7842-60	60	135	380	895	6 / 12

915

- Spare faces for item 7842

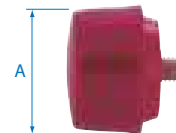

KT NO.	A mm		
91522H/S	22	11	10 / 160
91528H/S	28	22	10 / 100
91535H/S	38	38	6 / 120
91545H/S	45	70	6 / 36
91560H/S	60	137	6 / 24

Hammer Hook

91431

- Overall Size - W40 x D210 x H240 mm
- Weight - 411.6 g / Cuft - 0.072

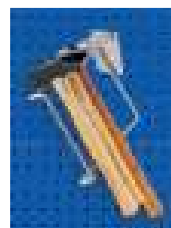

Chisel & Punch

- Material - chrome vanadium alloy steel
- Finishing - phosphate sunk

761

Center punch



KT NO.	Ø mm	L mm		
76103-04	3	100	33	12 / 336
76104-05	4	120	58	12 / 336
76105-06	5	150	129	12 / 144

763

Starter punch



KT NO.	Ø mm	L mm		
76301-05	1	120	57	12 / 336
76302-05	2	120	55	12 / 336
76303-05	3	120	57	12 / 336
76304-05	4	120	58	12 / 336
76305-05	5	120	59	12 / 336
76306-05	6	120	61	12 / 336
76307-05	7	120	101	12 / 240
76308-05	8	120	110	12 / 240
76309-06	9	150	141	12 / 144
76310-06	10	150	144	12 / 144



Chisel & Punch Set



CAUTION Please wear proper safety gear while working.

- Material - chrome vanadium alloy steel
- Finishing - phosphate sunk

765 Cape chisel



KT NO.	A mm	L mm	g	Box
76505-05	5	130	66	12 / 240

762 Flat chisel



KT NO.	A mm	L mm	g	Box
76210-10	10	250	135	12 / 144
76213-04	13	100	52	12 / 336
76213-06	13	150	82	12 / 144
76215-05	15	125	67	12 / 336
76217-06	17	150	140	12 / 144
76220-07	20	175	169	12 / 144
76223-08	23	200	295	12 / 72
76224-10	24	250	376	4 / 40
76226-12	26	300	649	4 / 32

764 Pin punch



KT NO.	Ø mm	L mm	g	Box
76402-45	2	115	31	10 / 640
76403-05	3	125	33	10 / 640
76403-06	3	150	39	10 / 250
76404-06	4	150	60	10 / 250
76405-65	5	165	68	10 / 280
76406-07	6	180	125	10 / 150
76408-08	8	200	162	10 / 120
76410-85	10	215	222	12 / 120
76412-09	12	230	349	10 / 80
76414-10	14	250	502	6 / 48

1005APR

5 PC.



Contents	g	Box
76104-05	0.32	8 / 48
76104-05		Ø 4 x 120
76215-05		15 x 125
76303-05		Ø 3 x 120
76404-06		Ø 4 x 150
76505-05		5 x 130

1006APR

6 PC.



Contents	g	Box
764	0.51	5 / 30
764		Ø 2 x 115, Ø 3 x 125
764		Ø 4 x 150, Ø 5 x 165
764		Ø 6 x 180, Ø 8 x 200

Flat Chisel & Punch Set

1090PR1

- Flat chisel & punch set

KT NO.	Contents	Each Qty	g	Cuff	
1090PR1	761	6	13.50	0.34'	
	761				Ø 4 x 120, Ø 5 x 150
	762				17 x 150, 20 x 175, 23 x 200, 24 x 250 mm
	763				4 x 120, 8 x 120 mm
	764				Ø 3 x 40, Ø 4 x 50, Ø 5 x 50, Ø 6 x 50, Ø 10 x 65
	767				150, 200 mm
8711B	600 x 240 x 60 mm	1	6.20	0.9'	
8711B-1	600 x 232 x 230 mm	1	2.00	1.7'	



90 PC.

Shelf size (mm) : 600 x 240 x 290



Punch Set

- Material - chrome vanadium alloy steel
- Finishing - phosphate sunk



► Pouch material : Teton



► Pouch material : Nylon



► Pouch material : Teton

KT NO.	PC.	Contents		Package		
1006PR	6		Ø 2 x 30, Ø 3 x 40, Ø 4 x 50, Ø 5 x 50, Ø 6 x 50, Ø 8 x 50	Nylon	0.57	1 / 20
1006PRN	6	764		Teton		
		761	Ø 4 x 120, Ø 5 x 150			
1016PR	6	762	20 x 175, 23 x 200	Nylon	0.84	1 / 20
		764	Ø 3 x 125, Ø 5 x 165			
1009PR	9		Ø 2 x 30, Ø 3 x 40, Ø 4 x 50, Ø 5 x 50, Ø 6 x 50, Ø 8 x 50,	Nylon	1.70	1 / 12
1009PRN	9	764	Ø 10 x 65, Ø 12 x 70, Ø 14 x 75	Teton		
		761	Ø 3 x 100, Ø 4 x 120, Ø 5 x 150			
1010PR	10	763	Ø 3 x 120, Ø 6 x 120, Ø 8 x 120	Nylon	0.88	1 / 24
		764	Ø 3 x 40, Ø 4 x 50, Ø 5 x 50, Ø 6 x 50			
1025PRN	5	762	13 x 100, 15 x 125, 17 x 150, 20 x 175, 23 x 200	Teton	0.79	1 / 20

Sheathed Chisel & Pin Punch

- Material - chrome molybdenum alloy steel
- Finishing - phosphate sunk
- Safe and comfortable grip

761-G Sheathed center punch



KT NO.	ø mm	L mm		
76125-74G	2.5	185	111	12 / 144
76104-74G	4	185	113	12 / 144
76106-74G	6	185	175	12 / 144
76108-74G	8	185	168	12 / 120
76110-74G	10	185	117	12 / 120

763-G Sheathed starter punch



KT NO.	ø mm	L mm		
76302-74G	2	185	111	12 / 144
76303-74G	3	185	111	12 / 144
76304-74G	4	185	112	12 / 144
76305-74G	5	185	115	12 / 144
76306-74G	6	185	118	12 / 144
76308-74G	8	185	166	12 / 120

762-G Sheathed flat chisel



KT NO.	A mm	L mm		
76218-75G	18	190	181	10 / 100
76219-75G	19	190	180	10 / 100
76220-84G	20	210	268	8 / 80
76222-84G	22	210	269	8 / 80

764-G Sheathed pin punch



KT NO.	ø mm	L mm		
76402-55G	2	140	50	12 / 384
76403-06G	3	150	53	12 / 384
76404-07G	4	180	96	12 / 144
76405-08G	5	200	110	12 / 144
76406-84G	6	210	163	12 / 120
76407-84G	7	220	163	12 / 120
76408-88G	8	220	174	12 / 96
76409-88G	9	230	183	12 / 96
76410-09G	10	250	246	10 / 80
76412-10G	12	290	347	8 / 64
76414-11G	14	350	443	6 / 48
76416-12G	16	310	594	6 / 36
76410-14G	10	350	358	10 / 60
76412-14G	12	350	476	6 / 36
76414-14G	14	350	521	6 / 36
76416-14G	16	350	670	5 / 30



Sheathed Pin Punch Set



► Pouch material : Tetoron

KT NO.	PC.	Contents		
1014GPN	4	∅ 10 x 350, ∅ 12 x 350, ∅ 14 x 350, ∅ 16 x 350	2.13	1 / 8
1006GPN	6	∅ 2 x 140, ∅ 3 x 150, ∅ 4 x 180, ∅ 5 x 200, ∅ 6 x 210, ∅ 8 x 220	0.80	1 / 8
1009GPN	9	∅ 2 x 140, ∅ 3 x 150, ∅ 4 x 180, ∅ 5 x 200, ∅ 6 x 210, ∅ 8 x 220, ∅ 10 x 230, ∅ 12 x 250, ∅ 14 x 290	1.82	1 / 12

Automatic Center Punch

768

- Material : handle - brass, tip - S2
- Spring-loaded trigger design for using without a hammer

KT NO.	∅ mm	L mm		
76804-05	1.3	130	75.0	30 / 120
76807-06	1.7	155	142	30 / 120



Flat Chisel & Set

767

- Ribbed type

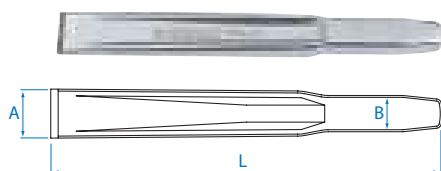

KT NO.	A mm	B mm	L mm		
76717-05	17	12.6	125	88	12 / 240
76721-06	20	16.0	150	147	12 / 144
76724-08	25	19.0	200	264	12 / 72
76729-10	29	22.3	250	454	8 / 48

11104PR



4 PC.

Contents 1.37 1 / 10

	76717-05	17 x 125
	76721-06	20 x 150
	76724-08	25 x 200
	76729-10	29 x 250
	87108	

11104PR10



4 PC.

Contents 1.0 1 / 20

	76717-05	17 x 125
	76721-06	20 x 150
	76724-08	25 x 200
	76729-10	29 x 250

87108

- Acrylic display stand

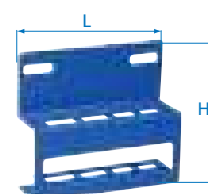

KT NO.	H mm	L mm		
87108	140	160	410	12



Marking Punch



CAUTION Please wear proper safety gear while working.

11409SQ

- Chrome vanadium alloy steel
- Hardened and tempered control HRC60 for safe use
- Invert number 6 to be number 9 (For 11409SQ)
- The letter A~Z with extra "&" (ampersand) included (For 11427SQ)



• The position hole help to fix the marking punch



11409SQ

11427SQ



11427SQ

KT NO.	Font size		Contents	Shank mm ²	L mm	Kg	Box / Carton
	mm	inch					
11409SQ02	2.0	5/64"	9 PCS 0~9	6.35	61	0.18	1 / 120
11409SQ03	3.0	1/8"		6.35	61	0.18	1 / 120
11409SQ04	4.0	5/32"		6.35	59	0.18	1 / 120
11409SQ05	5.0	3/16"		8	61	0.28	1 / 80
11409SQ06	6.0	1/4"		9.53	61	0.43	1 / 60
11409SQ08	8.0	5/16"		12.7	71	0.78	1 / 30
11427SQ02	2.0	5/64"	27 PCS A~Z, &	6.35	61	0.52	1 / 50
11427SQ03	3.0	1/8"		6.35	61	0.52	1 / 50
11427SQ04	4.0	5/32"		6.35	59	0.52	1 / 50
11427SQ05	5.0	3/16"		8	61	0.82	1 / 30
11427SQ06	6.0	1/4"		9.53	61	1.25	1 / 20
11427SQ08	8.0	5/16"		12.7	71	2.33	1 / 10

Heavy Duty Marking Punch

11509SQ

- Chrome vanadium alloy steel
- Hardened and tempered control HRC60 for safe use
- Hardness reduced at striking end HRC40 to have longer life time
- Invert number 6 to be number 9 (For 11509SQ)
- The letter A~Z with extra "&" (ampersand) included (For 11527SQ)



11509SQ05

11527SQ



11527SQ05

KT NO.	Font size		Contents	Shank mm ²	L mm	Kg	Box / Carton
	mm	inch					
11509SQ05	5.0	3/16"	9 PCS 0~9	11	61	0.56	1 / 30
11527SQ05	5.0	3/16"	27 PCS A~Z, &	11	61	1.70	1 / 10



WORKSHOP TOOLS





KING TONY
9TBA600

3:1 HIGH THRUST
KING TONY 7CA82-30

KING TONY
9TD406-19M
9TD406-17M

KING TONY
7DM1100

Gear Puller & Set

- Material - chrome vanadium alloy steel
- Finishing - chrome plated & phosphate sunk

7962

- Two-Jaw gear puller

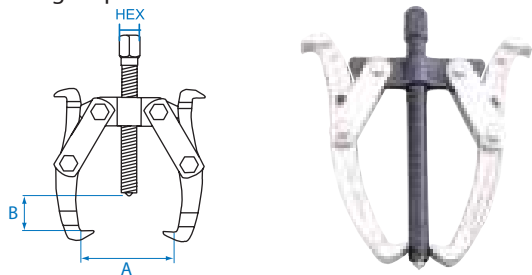

KT NO.	Capacity (tons)	HEX (mm)	Jaw (leg)	Spread (A)mm	Reach (B)mm	Kg	Box
7962-03	2	14	2	40~75	60	0.44	1 / 40
7962-04	4	17	2	50~100	95	0.78	1 / 20
7962-06	6	19	2	70~150	150	1.65	1 / 10
7962-08	10	23	2	95~200	235	3.50	1 / 5
7962-12	15	32	2	140~300	280	7.00	1 / 2

7963

- Three-Jaw gear puller

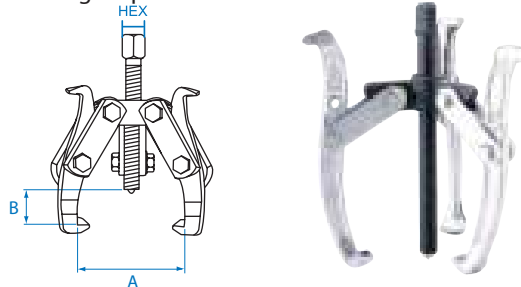

KT NO.	Capacity (tons)	HEX (mm)	Jaw (leg)	Spread (A)mm	Reach (B)mm	Kg	Box
7963-03	3	14	3	40~75	60	0.55	1 / 40
7963-04	6	17	3	50~100	95	1.06	1 / 20
7963-06	9	19	3	70~150	150	2.25	1 / 10
7963-08	15	23	3	95~200	235	4.50	1 / 5
7963-12	22	32	3	140~300	280	11.00	1 / 2

7962B

- Two-Jaw gear puller
- Adjustable sliding arm for efficiency and safety
- Reversible jaws for internal & external options gear, axle, bearing, etc...

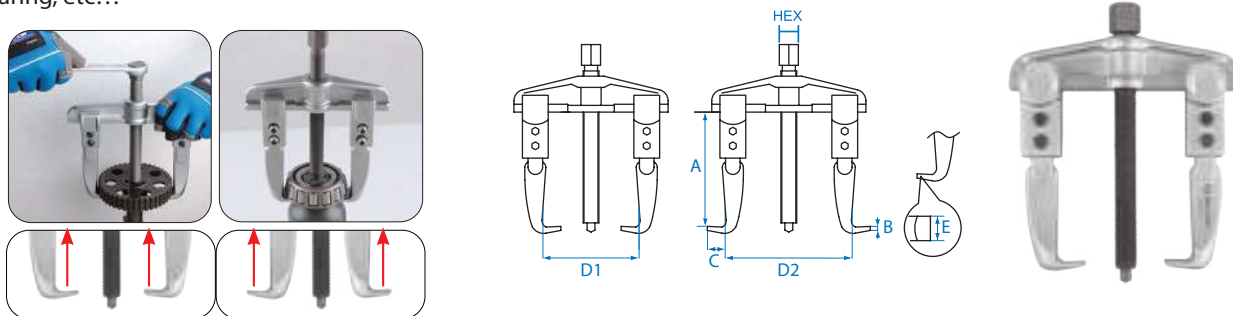

KT NO.	Capacity (tons)	Hex (mm)	Jaw (leg)	Reach A(mm)	B (mm)	C (mm)	Spread D1 (mm)	Spread D2(mm)	E (mm)	Kg	Box
7962B-35	3.0	17	2	100	3.8	14.5	90	60~125	21	1.05	1/12
7962B-05	5.0	17	2	100	3.8	14.5	130	60~160	21	1.15	1/12
7962B-06	5.0	22	2	150	4.6	23.0	150	85~200	30	2.98	1/6
7962B-08	7.5	22	2	150	4.6	23.0	190	105~230	30	3.41	1/6
7962B-10	7.5	27	2	210	7.0	30.0	240	130~300	35	7.11	1/3

7962B1PR

- Two-Jaw gear puller
- Adjustable sliding arm for efficiency and safety
- Reversible jaws for internal & external options gear, axle, bearing, etc...



Contents

18.20 Kg 1



7962B 3.5", 5", 6", 8", 10"

87155

Micro Bearing Puller

7965-02

- Applications include: alternators, generators, domestic appliances, power tools and pumps



- Adjust the jaws by turning the screw

KT NO.	Capacity (Tons)	Spread A(mm)	Reach B(mm)	Kg	Box
7965-02	2T	19-45	73	905	1 / 12

Two Sets Pressure Screw Bearing Separator Puller Set

9BA21

- 2 Sets bearing separator & bolts
- Contents:

(1) Bearing Separator

9BA21P02

Capacity 30mm ~ 50mm
Bolt 3/8" x 24UNF x L125mm

(2) Bearing Separator

9BA21P01

Capacity 50mm ~ 75mm
Bolt 1/2" x 20UNF x L 135mm

(3) 4 PC. Main rod

9BA21P04

Hex bar 14mm 3/8" x L 102mm x 2 pcs

9BA21P06

Hex bar 17mm 1/2" x L 127mm x 2 pcs

(4) 4 PC. Extension rod

9BA21P05

Hex bar 14mm 3/8" x L 102mm x 2 pcs

9BA21P07

Hex bar 17mm 1/2" x L 127mm x 2 pcs

(5) 1 PC. Beam

9BA21P03

Central Bolt

9BA21P011

(6) 9BA21P011

Hex 18mm x 9/16" x L175mm

⚖️ 5.25 📦 1 / 2



12 PC.

Pressure Screw Bearing Separator Puller Set

9BA22

- Includes bearing separator & bolts
- Contents:

(1) Bearing Separator

9BA22P01

Capacity 75mm ~ 105mm
Bolt 5/8" x 18UNF x L 165mm

(2) 2 PC. Main rod

9BA22P02

Hex bar 19mm x M12 & 1/2" x L 255mm

(3) 2 PC. Extension rod

9BA22P04

Hex bar 19mm x M12 x L 255mm

(4) 1 PC. Beam

(5) 1 PC. Central bolt

9BA22P011

Hex 21mm x M18 x L292 mm

(6) 1 PC. Nut

⚖️ 8.95 📦 1 / 2



8 PC.

Hydraulic Puller Set

9BA01

- Includes forged steel bearing separator and gear puller
- Operate up to 10 tons hydraulic pulling power
- Special separator design of the strong back puller allows the puller to be used even in the tightest spaces
- Suitable for industry, automotive and a gricultural machine

9BA22P011- Set Separator Capacity 75mm ~ 105mm

9BA22P03- 1 PC. Beam

9BA01P01- 1 PC. 10T Hydraulic Ram

9BA01P032- 1 PC. Tripe Head

9BA01P031- 1 PC. Twin Head

9BA01P033- 1 PC. Ram Part

9BA01P012- 1 PC. Centre Adapter

9BA01P013- 1 PC. 1"x 2" Extension Rod

9BA01P014- 1 PC. 1"x 4" Extension Rod

9BA22P02- 2 PC. Main Rod Hex bar 19mm x M12 & 1/2" x L255mm

9BA22P04- 2 PC. Extension Rod Hex bar 19mm x M12 x L255mm

9BA01P051- 3 PC. 4" Leg

9BA01P052- 3 PC. 6" Leg

9BA01P053- 3 PC. 8" Leg

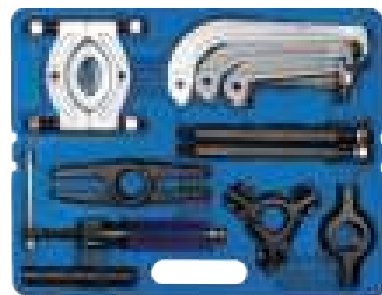

22 PC.

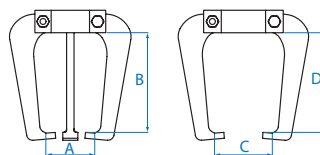

Size	Spread A (mm)	Reach B (mm)	Spread C (mm)	Reach D (mm)
4"	240	120	250	120
6"	190	170	310	170
8"	180	220	200	220



⚖️ 17.00 📦 1 / 1



Hydraulic Mechanical Pullers

9BA

- Quick and safe removal particularly large and tight gears, bearings, etc...
- Two and three jaws type, use for different space

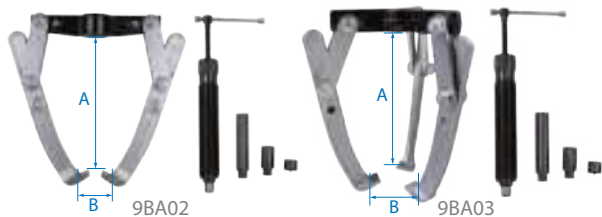

KT NO.	Capacity (Tons)	Jaws (leg)	Reach A(mm)	Spread B(mm)	kg	1 / 1
9BA02	15T	2	320	500	11.30	1 / 1
9BA03	15T	3	320	500	16.50	1 / 1

Universal Bearing Puller Set



9BA31

- Easy and fast removing ball bearing by using the puller
- Select proper tips by ball diameter

CONTENTS :

- 1 PC. Puller yoke M6 x1.0 and center screw Hex 12mm x160mmL
- 1 PC. Top Nut
- 2 PC. Extension rod x L 105mm
- Ball ended threaded adapter
- 2 PC. 5.5mm / 2 PC. 6.0mm / 2 PC. 8.0mm

kg 1.33 1 / 12



10 PC.

9BA32

1/2"

- Easy and fast removing ball bearing by using the puller
- Select proper tips by ball diameter

CONTENTS :

- 1 PC. Puller yoke 3/8-16UNC and center screw Hex 14mm x175mmL
- 1 PC. Top Nut
- 2 PC. Extension rod x L 100mm
- Ball ended threaded adapter
- 2 PC. 11.0mm / 2 PC. 12.5mm / 2 PC. 15.0mm

kg 2.00 1 / 12



10 PC.

9BA33

- Easy and fast removing ball bearing by using the puller
- Select proper tips by ball diameter

CONTENTS :

- 1 PC. Puller yoke M14 x2.0 and center screw Hex 21mm x280mmL
- 1 PC. Top Nut
- 2 PC. Extension rod x L 170mm
- Ball ended threaded adapter :
- 2 PC. 15.0mm / 2 PC. 17.4mm
- 2 PC. 20.0mm / 2 PC. 25.2mm
- 2 PC. 30.0mm / 2 PC. 36.4mm

kg 8.00 1 / 3



16 PC.

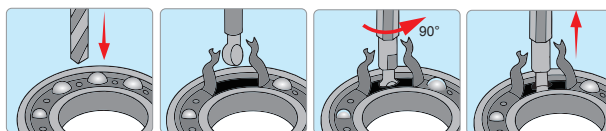

Slide Hammer Gear Puller Set

796401MR

Slide Hammer Puller Set

- For jobs involving pull and grip gears, bearings, outer races, grease retainers, oil seals, etc.
- 2.6 lbs(1.2 kgs) slide hammer
- 400 mm length T-handle puller
- 3-in-1 hammer puller, to handle inside pull such as bearing cups and outer races, as well as regular outside pull jobs

kg 4.50 1 / 4



6 PC.

CONTENTS:

- 1 PC. 400 mm T handle shaft
- 1 PC. 2.6 lbs / 1.2 kgs hammer
- 1 PC. Adjustable nut
- 1SET Internal gear puller for Ø15-30mm(A)
- 1SET Internal gear puller for Ø30-80mm(B)
- 1SET External gear puller for Ø15-80mm(C)

Items	D (mm)	Capacity
Internal gear puller	6	Ø 15-30mm
Internal gear puller	10.5	Ø 30-80mm
External gear puller	10.5	Ø 15-80mm



Riveter & Set

21-20-101

- Stainless steel riveter nozzles
- Drop-forged aluminum body



KT NO.	L		Capacity		kg	Crate
	inch	mm	inch	mm		
21-20-101	10-1/4	260	3 / 32	Ø 2.4	588	12 / 24
			1 / 8	Ø 3.2		
			5 / 32	Ø 4.0		
			3 / 16	Ø 4.8		

21-20-07MR

Blow case size (mm) :
276 x 160 x 46(0.122 cuft)



121 PC.

Contents	kg	Crate	Each Qty
4 x 8 mm	1.06	1 / 16	20
4 x 10 mm			
4 x 8 mm			
4 x 10 mm			
4.8 x 8 mm	1	1	1
4.8 x 10 mm			
21-20-101			

21-20-102

- 4 changeable sizes
- Stainless steel riveter
- The driver can be used in 90° and 180°

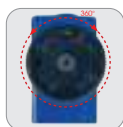

KT NO.	L		Capacity		kg	Crate
	inch	mm	inch	mm		
21-20-102	11	278	3 / 32	Ø 2.4	778	6 / 24
			1 / 8	Ø 3.2		
			5 / 32	Ø 4.0		
			3 / 16	Ø 4.8		

Riveter

79711

- Stainless steel riveter nozzles
- Drop-forged aluminum body
- Heavy duty riveter for stainless or aluminum rivets

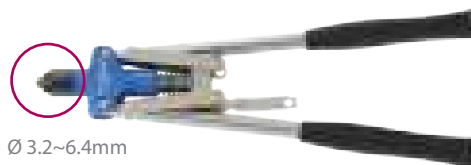

KT NO.	L		Capacity		kg	Crate
	inch	mm	inch	mm		
79711	18	460	1 / 8	Ø 3.2	1480	1 / 12
			5 / 32	Ø 4.0		
			3 / 16	Ø 4.8		
			1 / 4	Ø 6.4		

Expander Riveter

79721

- Expander framework design to press riveter
- 4 PC. Interchangeable nozzles
- Heavy duty riveter for stainless or aluminum rivets



KT NO.	L		Capacity		kg	Crate
	mm(min)	mm(max)	inch	mm		
79721	315	870	1 / 8	Ø 3.2	2.00	1 / 10
			5 / 32	Ø 4.0		
			3 / 16	Ø 4.8		
			1 / 4	Ø 6.4		

Blind Nut Riveter

21-30-09MR

- Designed for fastening object to thin metal
- 4 PC. interchangeable mandrels (M4, M5, M6, M8)
- 80 PC. iron nut rivet



85 PC.

KT NO.	L		Capacity	kg	Crate
	inch	mm			
21-30-09MR	10-1/2	265	M4 x 0.7	1.32	1 / 12
			M5 x 0.8		
			M6 x 1.0		
			M8 x 1.25		



Nut Riveter

79731

- Stainless steel nut riveter nozzles
- Drop-forged aluminum body
- Heavy duty riveter for stainless or aluminum rivet nuts

KT NO.	inch	L mm	Capacity	kg	Box
79731	18	472	M5	1.86	1 / 12
			M6		
			M8		
			M10		

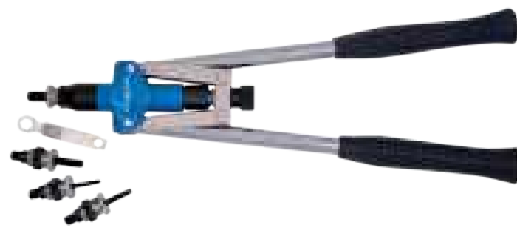

Measuring Tape

- Auto-Lock measuring tape
- Two retrieval buttons
- Nylon coating 3-rivet blade
- Ergonomic & shockproof ABS+TPE case
- Specially red marked each 10cm scale
- EU Class II accuracy standard approval

79093

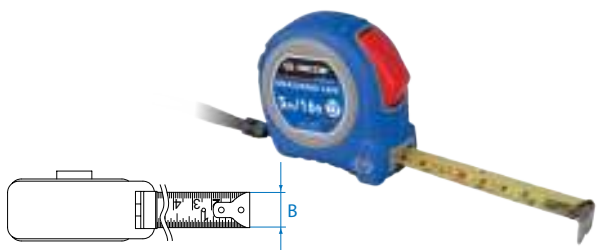

KT NO.	L M / FT	B mm	kg	Box
79093-02M	2M	16	110	16 / 64
79093-03M	3M	16	137	16 / 64
79093-05M	5M	19	210	14 / 56
79093-05M1	5M	25	260	12 / 48
79093-08M	8M	25	420	12 / 48
79093-03C	3M/10FT	16	137	16 / 64
79093-05C	5M/16FT	19	210	14 / 56
79093-08C	8M/26FT	25	420	12 / 48

79095-05M

79094-05M
16%

- Magnetic hook



KT NO.	L M / FT	B mm	kg	Box
79095-05M	5M	19	158	12 / 144

79095-05M-S

12 PC.

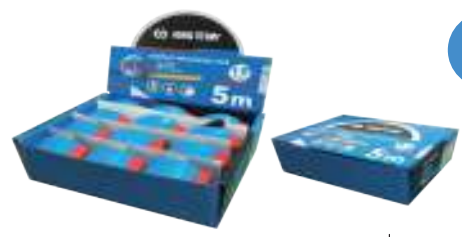

Contents	kg	Box
79095-05M x 12 PC.	1.90	1 / 10

79094

- Magnetic hook



KT NO.	L M / FT	B mm	kg	Box
79094-02M	2M	16	110	16 / 64
79094-03M	3M	16	137	16 / 64
79094-05M	5M	19	210	14 / 56
79094-08M	8M	25	420	12 / 48
79094-03C	3M/10FT	16	137	16 / 64
79094-05C	5M/16FT	19	210	15 / 60
79094-05C1	5M/16FT	25	260	12 / 48
79094-08C	8M/26FT	25	420	12 / 48

Paper Display Stand

87118

- Capacity : 12 PC.
- For all measuring tape (79093 / 79094 <02M,03M,05M>series)
- Paper display stand size(mm) : 309 x 237 x 189 (0.489 CUFT)



Full Color Laser Distance 60M

7DM1160

- Colorful LCD display for easily reading
- Functions : Single measure, continuous measure, area, volume, height, stake-out
- Six flexible ways for height measurement
- Universal 8 length units with auto-converting
- 360° inclination sensor for determining the horizontal and vertical distance
- 2 selectable measurement reference points : Front and rear
- Automatic orientation display
- CE Approval IEC 60825-1: 2014, EN 61326-1: 2013

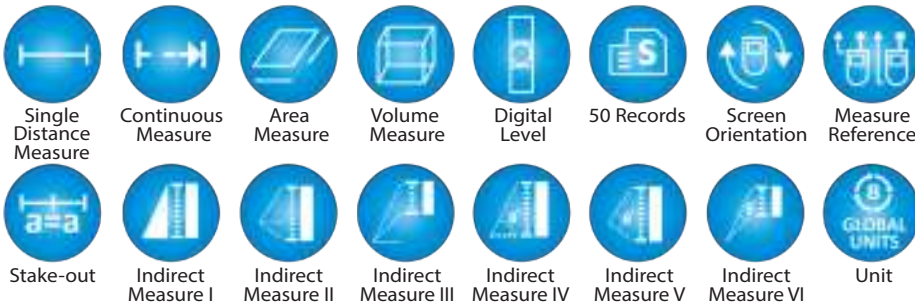

Technical data	
Display	Color LCD
Measuring Range	0.05 m ~ 60 m
Resolution	0.001 m
Accuracy	±1.5 mm
Laser Type	650 nm, Class II, < 1 mw
Unit(Selectable)	m, ft, in, 0'0" 1/32, 1/32in, 1/16in, 1/8in, 10/33
Battery Life	Up to 6,000 measures
Operation Temperature	-5° C ~ 40° C
Storage Temperature	-20° C ~ 60° C
Memory	50 set
IP code	54
Automatic Power-Off	Laser-120 seconds Device-180 seconds
Battery	AAA x 2 PC. Included



• Color LCD

Overview for device :

- A - LCD
- B - Single Measure
- C - Addition
- D - Subtraction
- E - Clear / Power
- F - Functions Included Single Measure, Continuous Measure, Area, Volume, Six Indirectly Height Measurements, Stake-out, Level, Unit and Setting
- G - Reference
- H - Receiving Lens
- I - Laser Emitted Window

KT NO.	Size (mm) L x W x H		
7DM1160	105 x 48 x 21	200	1 / 40

Measuring

79062

- Adjustable square measuring with angle spirit level 305mm
- Sliding combination of square, spirit level, height gauge and steel rule
- 90° and 45° level allow try-square and metre-square work
- Metal scriber pin in the end
- Metric and imperial marking at both sides
- Precision cast zinc alloy and stainless blade
- For woodwork

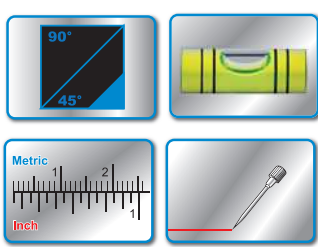

KT NO.	mm	Inch		
79062-12	305	12	312	12 / 72



Stainless Ruler

79063

- Stainless steel deeply etched for easy reading
- Dual scale : metric & imperial marking (mm/inch)

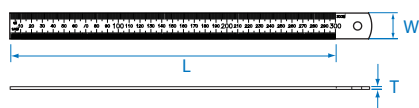

KT NO.	L		W mm	T mm	g	Box/Kit
	mm	Inch				
79063-06	150	6	13	0.6	12	10 / 500
79063-12	300	12	30	0.8	65	10 / 300
79063-20	500	20	30	0.8	105	10 / 250
79063-40	1000	40	30	0.8	360	10 / 100

Calipers

77131

- Vernier calipers parallax free
- Parallax free bevel scales for easy and accurate measurement
- 4 way measurement capability for outside, inside, depth and step measurement
- The caliper is made of hardened stainless steel

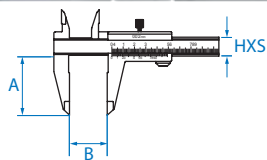

KT NO.	A mm	B max mm	Vernier mm	H x S mm	g	Box/Kit
77131-08	50	200	0.02	20 x 4	450	1 / 50

77141

- Digital calipers
- Digital display slide calipers with thumb roller
- Large clear LCD on/off, metric/imperial, zero switches
- Hold function allows quick and efficient inspection record
- Made of hardened stainless steel

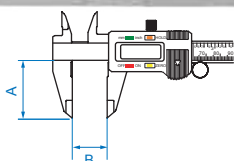

KT NO.	A mm	B max		Resolution		g	Box/Kit
		mm	Inch	mm	Inch		
77141-06	40	150	6	0.01	0.001	320	1 / 20
77141-08	50	200	8	0.01	0.001	485	1 / 50

Metric Feeler Gauge

- Material: blade made of spring steel

77340-20

- 20 blades metric feeler gauge

CONTENTS :

- 0.05, 0.10, 0.15, 0.20, 0.25, 0.30, 0.35, 0.40, 0.45, 0.50, 0.55, 0.60, 0.65, 0.70, 0.75, 0.80, 0.85, 0.90, 0.95, 1.00 mm



KT NO.	Number of blades	Width x Length of blades (mm)	g	Box/Kit
77340-20	20	10 x 100	105	50 / 200

77335-25

- 25 blades metric feeler gauge

CONTENTS :

- 0.04, 0.05, 0.06, 0.07, 0.08, 0.09, 0.10, 0.15, 0.20, 0.25, 0.30, 0.35, 0.40, 0.45, 0.50, 0.55, 0.60, 0.65, 0.70, 0.75, 0.80, 0.85, 0.90, 0.95, 1.00 mm



KT NO.	Number of blades	Width x Length of blades (mm)	g	Box/Kit
77335-25	25	13 x 85	105	50 / 200

77328-26

- 26 blades inch feeler gauge

CONTENTS :

- 0.0015", 0.002", 0.0025", 0.003",
- 0.004", 0.005", 0.006", 0.007",
- 0.008", 0.009", 0.010", 0.011",
- 0.012", 0.013", 0.014", 0.015", 0.016", 0.017", 0.018", 0.019", 0.020", 0.021", 0.022", 0.023", 0.024", 0.025"
- 0.038, 0.051, 0.063, 0.076, 0.102, 0.127, 0.152, 0.178, 0.203, 0.229, 0.254, 0.279, 0.305, 0.330, 0.356, 0.381, 0.406, 0.432, 0.457, 0.483, 0.508, 0.533, 0.559, 0.584, 0.610, 0.635 mm



KT NO.	Number of blades	Width x Length of blades (mm)	g	Box/Kit
77328-26	26	12.7 x 76	91	14 / 168



Roller Chain Detacher

3214



KT NO.	For chain size ANSI NO.		
3214-35	35~50	310	1 / 60
3214-60	60~100	691	1 / 20

Revolving Punch Pliers

74A00

- To punch holes into leather, textiles and soft material
- Revolving steel head has unique waste collection facility



KT NO.	Punch size mm ²	Overall length mm		
74A00	2, 2.5, 3, 3.5, 4, 4.5	230	366	10 / 60

Retractable Tool Lanyard

79A21-30

79A22-30

- Retractable tool lanyard
- 3 kgs maximum tool weight
- Nylon tether with steel spring inside to absorb the shock of a dropped tool
- Increases safety and productivity
- Ergonomically designed length



79A21-30



79A22-30



KT NO.	Capacity mm	Hook		
79A21-30	800~1300	2 lock snaps	106	12 / 144
79A22-30	800~1300	fixed loop	89	12 / 144

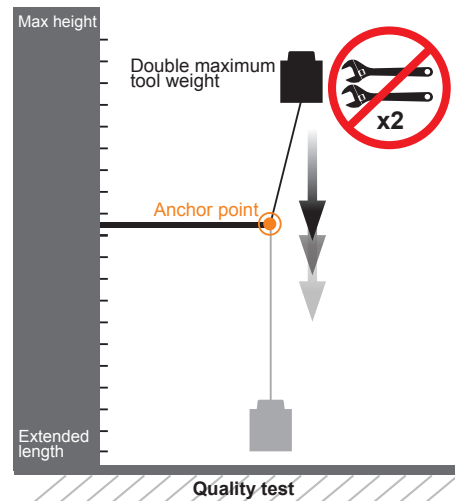

- The retractable tool lanyards are developed according to KING TONY standard. The steel lanyards are tested by double maximum weight and dropped from height. Product quality is approved.



Round Magnetic Tool Holder



9TE11

- Stainless steel tray resists corrosion
- Can be used horizontally, vertically, and upside down
- Convenient for collecting small parts and tools



KT NO.	Size mm		
9TE11	Ø 150	433	1 / 30

PU Working Gloves



9TH31-XL

9TH31-2L

- Strap design for easy adjustments
- Comfortable and breathable fabric material



KT NO.	Size	Width mm	Overall Length mm		
9TH31-XL	XL	107	235	70	100
9TH31-2L	2L	112	240	70	100

Anti-vibration Protective Gloves

9TH21XL

- Protection from repetitive impact and vibration of pneumatic tools
- Magnet in back of glove for storing metal parts and fasteners

110 100



KT NO.	Size	Width mm	Overall Length mm		
9TH21XL	XL	112	235	110	100

Lightweight PU Work Gloves

9TH41

- PU leather offers high dexterity, sensitivity, excellent grip and good comfort
- Mesh fabric provides good breathability
- Elastic band cuff with label velcro provides firm fitting
- EN388 2121X



KT NO.	Size	Width mm	Overall Length mm		
9TH41-L	L	105	230	67	120
9TH41-XL	XL	110	240	72	120

Vibration Resistant Work Gloves

9TH42

- Goat leather palm provides high dexterity and comfort with EVA padding for anti-vibration
- Touch screen capable fingertips
- Mesh fabric provides good breathability
- Neoprene cuff with velcro adjustment ensures firm fitting
- EN388 2111X



KT NO.	Size	Width mm	Overall Length mm		
9TH42-XL	XL	115	250	98	120
9TH42-XXL	XXL	120	260	102	120

Silicone Non-slip Work Gloves

9TH43

- Durable palm with anti-slip silicone for excellent grip. EVA padding for anti-vibration
- Reflective piping ensure safe work in dark
- Elastic band cuff with label velcro provides firm fitting
- EN388 2111X



KT NO.	Size	Width mm	Overall Length mm		
9TH43-XL	XL	115	247	102	120
9TH43-XXL	XXL	120	257	108	120

Cold Protection Work Gloves

9TH44

- Nubuck leather palm is breathable, foam insert for extra comfort and anti-vibration
- Reflective piping ensure safe work in the dark
- Neoprene cuff with velcro adjustment ensures firm fitting
- Thinsulate insulation lining offers extra warmth
- EN388 2111X



KT NO.	Size	Width mm	Overall Length mm		
9TH44-XL	XL	120	250	105	120
9TH44-XXL	XXL	125	260	113	120

Magnetic Work Gloves

9TH45

- Durable palm with magnetic index finger
- Powerful magnetic on back for storing metal parts & fasteners
- Elastic band cuff with label velcro to ensure firm fitting
- EN388 3111X



KT NO.	Size	Width mm	Overall Length mm		
9TH45-XL	XL	120	250	92	120
9TH45-XXL	XXL	125	260	98	120

Silicone Trowel & Scraper

7AA105

- Suitable for removing old caulking and replacing new caulking
- The trowel head with chamfer which is easy for smooth sealing lines
- The stainless tip prevent the surface from being damaged



KT NO.	Size	Overall length mm		
7AA105	3R, 6R, 10R, 13R, 17R	204	100	24 / 48



5 PC.

- Includes Five different nozzle pad head

High Thrust Caulking Gun

7CA81-30H

- Cartridge caulk gun
- For 10oz / 300ml cartridges
- 26:1 high thrust ratio provide 450 kgf push force
- Apply extremely thicker materials and adhesives
- Smooth action provide cleaner sealant



- Adjustable screw tightening increases product lifespan

KT NO.	Overall length mm		
7CA81-30H	357	814	1 / 10



26:1 Thrust ratio



High Thrust Aluminum Tube Caulking Gun

7CA82-30

- Suitable for 310ml cartridges or bulk
- Professional caulk gun with 18:1 high thrust ratio
- Includes nozzle and pad
- 350kgs maximum thrust power, perfect for applying thicker materials, adhesives
- Application: glass, windowsill, bathroom, etc.

KT NO.	Overall length mm		
7CA82-30	352	965	1 / 10



18:1 Thrust ratio



Butane Torch

6BB11

- Adjustable flame length with a maximum temperature of 1300°C / 2450°F and will operate on a single fill for 60~90 minutes
- Quick and easy to refill gas only 5 seconds
- A ceramic partition in the nozzle, fast heat dissipation and high safety
- Aluminium body, lightweight and portable
- Built in child proof safety lock system
- Applications include soldering, brazing, heat shrink tubing, frozen locks, fusing rope ends, camping, etc...
- Suitable for workshops, factories and daily professional use
- Anti-flare gas flow tube
- Piezo ignition for instant flame

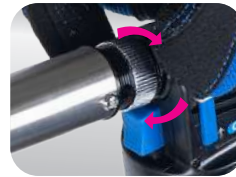
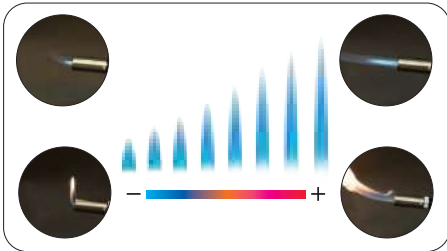

• Refilling gas

• Turn the air flow control switch to change the fire type



• Push the safety latch up

• Turn the gas flow control switch counter-clockwise

• Press the ignition button

KT NO.	Gas Capacity (ml)	Operation Time (min)	Gas Type	flame Temp °C/°F	Dimension L x W x H (mm)		
6BB11	34	60~90	Butane	1300 / 2450	122 x 70 x 168	400	12 / 24

Cordless Butane Gas Glue Gun

6BJ21

- Self-regulating temperature system, avoiding the glue keeping coming out to stuck the nozzle or drip everywhere
- Fast-heating in 2 to 3 Minutes
- Quick and easy to refill gas only 3s, keeps running for approximately 1.5 hours
- Front top heater design for safety usage
- Portable and cordless for convenient application
- Passed the 250 hour continuous work durability test
- Included 2 PC. 11mm glue stick
- Suitable for wood workings, household repairs, artificial flowers, models, art and decorations etc...
- Optional glue stick 6BJ901, pack by 10 PC.
- Ergonomic comfort grip



6BJ21

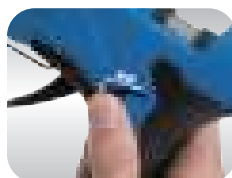
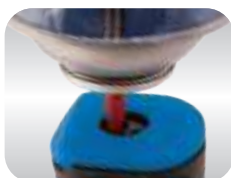

• Refilling gas

• Turn the gas switch on

• Press the ignition button and wait 2-3 min (Make sure the indicator on)

• Automatic temperature control turns off at 180° and turns on under 160°



6BJ901

KT NO.	Gas Capacity (ml)	Operation Time (min)	Glue size (mm)	Gas Type	Operating Temp °C	Dimension(mm) L x W x H		
6BJ21	6.8	90	11	Butane	160-180	175 x 36 x 155	241	1 / 10
6BJ901	-	-	11	-	-	∅11 x 150mm	140	10



360° Cast Steel BenchVise & Display Rack

9TZ11

- Cast steel body and slide ideal for heavy duty applications
- Ductile cast iron screw pitched acme thread ensures long life and positives action
- Serrated jaws design provides good grip
- 360° swivel base allows operator to approach any direction



- Applicable for round shape objects

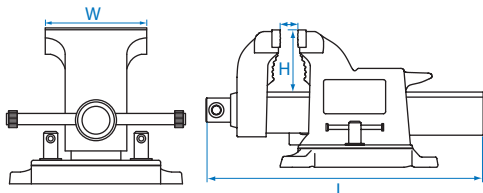

KT NO.	mm	W		H mm	L mm	Kg	Cubes
		inch	mm				
9TZ11-04	146	4"	104	57	310	7.50	1
9TZ11-05	166	5"	130	67	365	11.00	1
9TZ11-06	200	6"	155	76	422	14.50	1
9TZ11-08	225	8"	200	89	492	18.00	1
9TZ11-10	250	10"	250	102	572	25.60	1
9TZ11-12	300	12"	305	127	655	33.00	1

Steel Wire Brush Set

9CZ201-S



20 PC.

Contents

Contents	Kg	Cubes
9CZ201 x 20 PC.	2.70	1 / 8

Broken Screw Extractor Set

11205SQ

- A quick and easy way to remove broken screw, pipe, bolt and stud

100 25 / 100

5 PC.

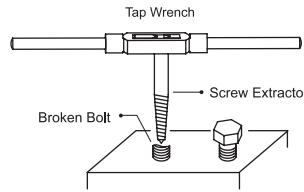

KT NO.	Capacity		L mm
	mm	inch	
2127-06M	M3~M6	1/8~1/4	51.5
2127-08M	M6~M8	1/4~5/16	58.0
2127-11M	M8~M11	5/16~7/16	66.0
2127-14M	M11~M14	7/16~9/16	73.5
2127-18M	M14~M18	9/16~3/4	81.0

11208SQ

- Quick and easy to remove broken screw, pipe, bolt and stud

829 6 / 24

8 PC.



KT NO.	Capacity		L mm
	mm	inch	
2127A-06M	M3~M6	1/8~1/4	51.5
2127A-08M	M6~M8	1/4~5/16	58.0
2127A-11M	M8~M11	5/16~7/16	66.0
2127A-14M	M11~M14	7/16~9/16	73.5
2127A-18M	M14~M18	9/16~3/4	81.0
2127A-24M	M18~M24	3/4~1	91.0
2127A-33M	M24~M33	1~1-3/8	106.0
2127A-50M	M33~M50	1-3/8~2	112.0

Broken Screw Extractor and Drill-Bit Set

11310SQ

- Material : Drill-Bit(HSS), screw extractor(GCr15)
- Metal case size (mm) :
149 x 115 x 24 (0.014 cuft)

Contents

0.4 1 / 40

	ø2.5, ø3, ø4.5, ø6, ø8
	#1 M3 - M6 1/8" - 1/4"
	#2 M6 - M8 1/4" - 5/16"
	#3 M8 - M11 5/16" - 7/16"
	#4 M11 - M14 7/16" - 9/16"
	#5 M14 - M18 9/16" - 3/4"

10 PC.







Speed Out Broken Screw Extractor Set

11406SQ

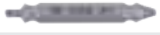
- For stripped, broken, stuck or damaged screw removal
- Size includes: #0, #1, #2, #2, #3, #4
- High hardness HSS material makes drilling easier and faster
- The screw extractor set is tested with quality, efficiency, durability and stability

82 12 / 96

Specifications	Drill Size Ø H1	Suitable for Screw Diameter
	2.5	2-3mm
	3.0	3-5mm
	3.5	4-8mm
	3.5	4-8mm
	4.0	5-10mm
	6.0	6-12mm



6
PC.

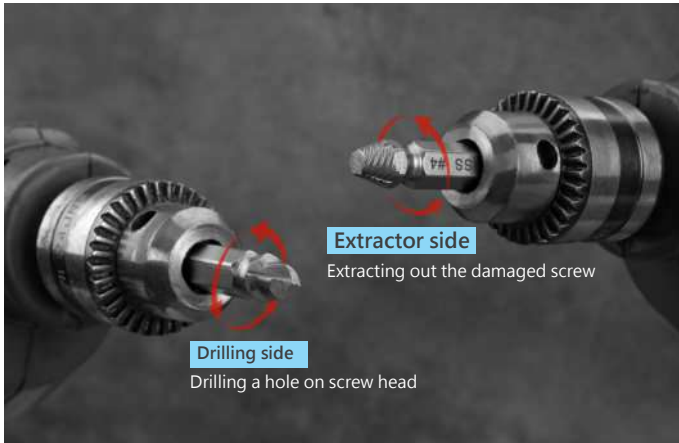
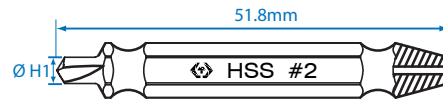

3 steps:

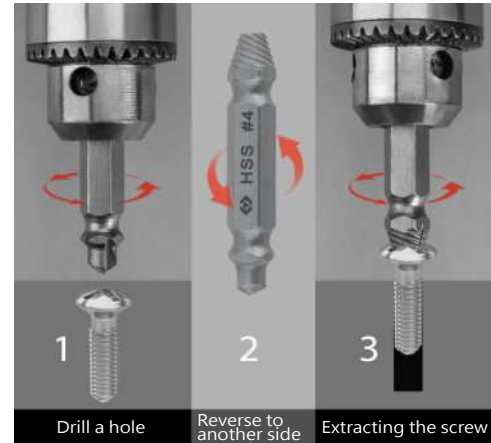

Broken Screw Extractor & Drill Set

11225SQ

- Easy to remove 5~14 mm broken screws
- 15 PC. HSS drill bit & center guide
- 10 PC. extractor pin & nut

0.79 1 / 20

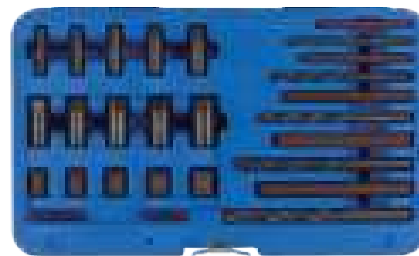
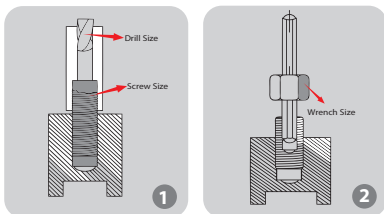

25
PC.

Blow case size (mm) :
260 x 175 x 60 (0.096CUFT)



- Use the guide to drill a pilot hole in the center of broken screw



- Put on extractor nut turning out broken screw with wrench

Nut Splitter Set

9TD062

- For removing stubborn nuts or over tightened bolts without damaging the bolt thread
- Suitable for nuts to a tensile class 6
- Do not overtighten to prevent damage to the threads under the nut

0.61 / 12 / 36

KT NO.	inch	Capacity mm	Hex (mm)
9TD602	1/2"~5/8"	12~16	14
9TD603	5/8"~7/8"	16~22	19



9TD064

Blow case size (mm) :
260 x 175 x 60 (0.096CUFT)

1.89 / 1 / 12

KT NO.	inch	Capacity mm	Hex (mm)
9TD601	5/16"~1/2"	9~12	12
9TD602	1/2"~5/8"	12~16	14
9TD603	5/8"~7/8"	16~22	19
9TD604	7/8"~1-1/8"	22~27	21



1/2" DR. Damaged Nuts Remover Socket & Set



Can't be used with pneumatic wrench

9TD403

1/2"

- Made of top quality SNCM alloy steel, provide good wear resistance and durability
- Ideal for the removal of rounded, damaged or corroded nuts, bolts, oil drain plugs, marine nuts and bolts, exhaust manifold nuts, pipe nozzle, and studs
- No need for pounding, chisels or torches

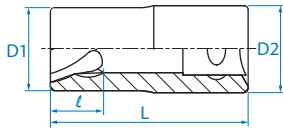

KT NO.	D1 mm	D2 mm	l mm	L mm		
9TD403-10M	16.0	22	8	50	76	10 / 180
9TD403-12M	18.0	22	11	50	78	10 / 180
9TD403-13M	20.0	22	11	50	85	10 / 180
9TD403-14M	21.0	22	11	50	88	10 / 180
9TD403-17M	24.5	25	15	50	113	10 / 180
9TD403-19M	27.0	27	15	50	124	8 / 80
9TD403-21M	29.4	27	16	50	139	8 / 80
9TD403-22M	30.5	27	17	50	140	8 / 80
9TD403-23M	31.8	27	17	50	119	8 / 80
9TD403-24M	33.0	27	17	50	143	8 / 80
9TD403-27M	36.0	27	18	50	145	8 / 80

9TD

1/2"

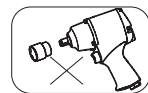

KT NO.	Contents		
9TD034MR	21, 22, 23, 27	0.58	4/36
9TD035MR	9TD403 12, 13, 14, 17, 19	0.52	
9TD036MR	10, 12, 13, 14, 17, 19	0.60	



Roller Stud Extractor Socket & Set

9TD401

1/2"

- For tightening or loosening studs

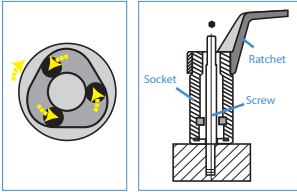

KT NO.	mm	D1 mm	D2 mm	L mm	kg	1 / 8
9TD401-06M	6	24.5	21	60	131	10 / 180
9TD401-08M	8	24.5	21	60	128	10 / 180
9TD401-10M	10	27.5	21	69.5	180	12 / 120
9TD401-12M	12	27.5	21	69.5	179	12 / 120

9TD014MR

1/2"

- 4 stud drivers for sizes M6, M8, M10 and M12

0.83 kg 1 / 30

Blow case size (mm) :
210 x 111 x 49 (0.04CUFT)



4 PC.

Stud Remover Tool

9TD404-0619M

- Stud range: 6-19mm (1/4" - 3/4")
- Allows for easy removal of studs. Turn extractor with a ratchet, wrench or socket to engage the cam and stud, then pull out stud

0.64 kg 1 / 24

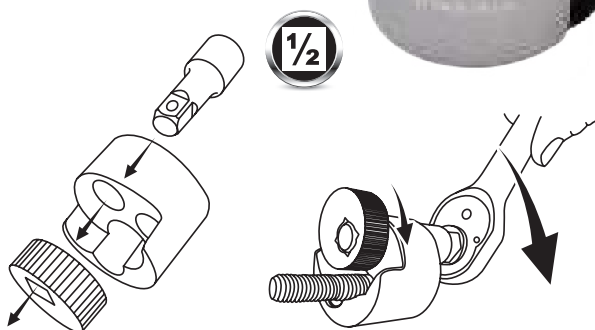

Long Twist sockets set

- For removing damaged wheel nuts and locking nuts. Especially useful on deep seated wheel nuts on modern alloys
- Twisting socket design is easily to remove stripped lug nut
- Straight kick out bar 12x160mmL
- Length:146mm

9TD164MR

4 PC.



Contents

1.36 kg 1 / 8

9TD406	17, 19, 21
7641206P	

9TD165MR

5 PC.



•Grip and remove damage bolt



•Kick out grip bolt by punch ground or hammer

Contents

1.70 kg 1 / 8

9TD406	17, 19, 21, 22
7641206P	



Aviation Tin Snips

74010~74060

- Special drop forged CRMO with induction hardened edges 62HRC
- Blades with serrated edges fast cuts in sheet metal, aluminum, and much more
- Cut 1.2mm cold-rolled steel (18GA) low carbon steel
- Non-slip color code grips for superior control
- 74040 Notching bulldog style with higher cutting ability
- 74060 Extra-long compound action style compare to tin snips
- Special laborsaving design
- High tensile strength
- High torsional strength spring
- Solid and comfortable handle with non-slip design
- Hang-up hole for convenient storage
- Safety auto latch (D.PAT.)

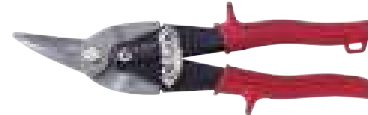

74010

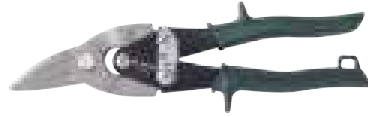

74020

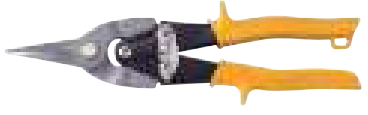

74030



74040



74060

KT NO.	Overall length mm	Cutting length mm	Color of handle	Copper (soft)	Cutting capacities (mm)			Stainless steel304	Scales	Boxes
					Cold-rolled steel (soft)	Hard steel HRC 30 (Hard)				
74010	248	35	Red	1.50	1.20	0.80	0.70	375	6 / 48	
74020	248	35	Green	1.50	1.20	0.80	0.70	375	6 / 48	
74030	250	38	Yellow	1.50	1.20	0.80	0.70	380	6 / 48	
74040	230	25	Yellow	2.00	1.60	1.20	1.20	370	6 / 36	
74060	290	75	Orange	1.10	0.94	0.70	0.53	450	6 / 36	

Figure Tin Snips

74250~74270

- Special drop forged CRMO with induction hardened edges 63HRC
- Blades with serrated edges fast cuts in sheet metal, aluminum, and much more
- Cut 1.5mm cold-rolled steel (16GA) low carbon steel
- Non-slip color code grips for superior control
- Special laborsaving design
- High tensile strength provided
- High torsional strength spring designed
- Solid and comfortable handle with non-slip design
- Hang-up hole for convenient storage
- Safety auto latch (D.PAT.)

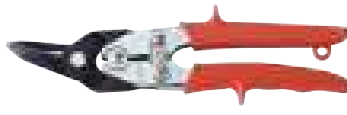

74250



74260



74270

KT NO.	Overall length mm	Cutting length mm	Color of handle	Copper (soft)	Cutting capacities (mm)			Stainless steel304	Scales	Boxes
					Cold-rolled steel (soft)	Hard steel HRC 30 (Hard)				
74250	260	35	Orange	1.80	1.50	1.00	0.90	480	6 / 36	
74260	260	35	Blue	1.80	1.50	1.00	0.90	480	6 / 36	
74270	260	35	Yellow	1.80	1.50	1.00	0.90	480	6 / 36	



Straight Pattern Snips

74410~74416

- Drop forged of finest quality steel induction hardened edges 60HRC
- Cuts straight flat face guides tool along straight line
- Blades individually hand edged for maximum cutting efficiency
- Cushion handle for comfort and better grip



74410 ~ 74416

KT NO.	Overall length mm	Cutting length mm	Copper (soft)	Cutting capacities (mm)			Stainless steel304	Scales	Box / Carton
				Cold-rolled Steel (soft)	Hard steel HRC 30 (Hard)				
74410	254	51	0.94	0.78	0.60	0.45	480	6 / 36	
74412	305	70	1.15	0.91	0.70	0.63	650	6 / 24	
74414	356	76	1.41	1.20	1.00	0.70	780	6 / 24	
74416	415	63	2.00	1.60	1.20	1.00	1700	3 / 12	

Curved Tin Snips

74512

- Drop forged of finest quality steel induction hardened edges 60HRC
- Double curved, hollow ground blades reduce friction for easier cutting
- British Gilbow type
- Cushion handle for comfort and better grip

74514



74512 / 74514

KT NO.	Overall length mm	Cutting length mm	Copper (soft)	Cutting capacities (mm)			Stainless steel304	Scales	Box / Carton
				Cold-rolled steel (soft)	Hard steel HRC 30 (Hard)				
74512	305	60	1.15	0.91	0.70	0.63	670	6 / 24	
74514	356	65	1.40	1.20	1.00	0.70	920	6 / 24	

Duckbill Pattern Snips

74613

- Drop forged of finest quality steel induction hardened edges 60HRC
- Cuts moderately tight curves left, right or straight in light stock
- Blades individually hand edged for maximum cutting efficiency
- Cushion handle for comfort and better grip



KT NO.	Overall length mm	Cutting length mm	Copper (soft)	Cutting capacities (mm)			Stainless steel304	Scales	Box / Carton
				Cold-rolled steel (soft)	Hard steel HRC 30 (Hard)				
74613	330	72	1.20	0.84	0.61	0.61	720	6 / 24	

Saw

7911-12

- Sliding metal bow
- Lightweight, resistant to oxidization and oil
- Two blade positions 45° and 90° including flush cut
- Ergonomic handle with hand stop
- Handle material : Zinc frame, soft grip TPR handle



KT NO.	Adjustable blade length (mm)	Overall length mm	Scales	Box / Carton
7911-12	300	400	637	6 / 36



Saw

7921-12

- Sliding metal bow
- Handle material : ABS+TPR
- Lightweight & anti-slippery
- Four blade positions 45°, 90°, 135°, 180° including flush cut
- Spare blades can be stored



KT NO.	Adjustable blade length (mm)	Overall length mm		
7921-12	300	510	555	12 / 24

File

7510G

- Flat file



KT NO.	Size mm		L mm			
75101-08G	8		200	4.8	20.0	188 2 / 40
75101-10G	10		250	5.7	23.6	292 2 / 40
75102-08G	8		200	4.8	20.0	190 2 / 40
75102-10G	10		250	5.7	23.6	293 2 / 40

7520G

- Half round file



KT NO.	Size mm		L mm			
75201-08G	8		200	6.7	19.9	190 2 / 40
75201-10G	10		250	7.0	23.5	292 2 / 40
75202-08G	8		200	6.7	19.9	184 2 / 40
75202-10G	10		250	7.0	23.5	291 2 / 40

7530G

- Round file



KT NO.	Size mm		L mm			
75302-08G	8		200	7.2	127	2 / 40
75302-10G	10		250	9.2	172	2 / 40

7540G

- Triangle file



KT NO.	Size mm		L mm			
75402-08G	8		200	13.0	175	2 / 40
75402-10G	10		250	14.9	284	2 / 40

7550G

- Square file



KT NO.	Size mm		L mm			
75501-08G	8		200	7.5	130	2 / 40
75501-10G	10		250	9.5	210	2 / 40
75502-08G	8		200	7.5	128	2 / 40
75502-10G	10		250	9.5	205	2 / 40

File Set

1005GQ

- Bastard cut
- Designed for steel, cast iron, brass, and hard plastics
- Pouch material : Nylon

1015GQ



5 PC.

KT NO.	Contents	L inch		
1005GQ (for 8")	75102-08G	8"	0.9	1 / 20
	75202-08G			
	75302-08G			
1015GQ (for 10")	75102-10G	10"	1.4	1 / 8
	75202-10G			
	75302-10G			



Needle File Set

• Pouch material : PVC

1036ZQ

- Perfect for filing off sharp edges, reshaping cuts or reaming drilled holes
- #60 grit diamond coating surface



6
PC.

Contents

L mm

75135-06	75435-06	160	95	10 / 120
75235-06	75535-06			
75335-06	75035-06			

Tapered Reamer

7E61001

- For deburring and sizing the diameter of holes 1/8" to 3/8"
- Suitable for metal, wood or plastic

70 24 / 96

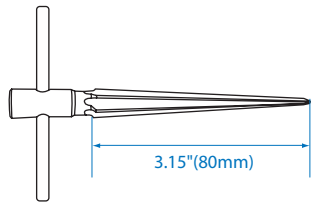
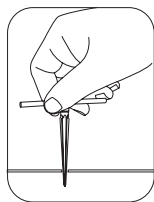

Threaded Coil-Insert Repair Set

11311MQ

- Thread tap for most common metric size : M5, M6, M8 and M10
- Used for repairing and restoring damaged threads
- Suitable for machine, engine and other automotive repair applications



119
PC.

Metal case size (mm) : 350 x 216 x 40

Contents

2.78 1 / 5

	Screw-Coil:	
	M5x0.8x1.5D(L:7.5mm)	25 PC.
	M6x1.0x1.5D(L:9mm)	25 PC.
	M8x1.25x1.5D(L:12mm)	25 PC.
	M10x1.5x1.5D(L:15mm)	25 PC.
	Tap:	
	M5x0.8	1 PC.
	M6x1.0	1 PC.
	M8x1.25	1 PC.
	M10x1.5	1 PC.
	Tang Puncher:	
	M5x0.8	1 PC.
	M6x1.0	1 PC.
	M8x1.25	1 PC.
	M10x1.5	1 PC.
	Drill:	
	5.2mm	1 PC.
	6.3mm	1 PC.
	8.3mm	1 PC.
	10.4mm	1 PC.
	Main Tool:	
	M5x0.8	1 PC.
	M6x1.0	1 PC.
	M8x1.25	1 PC.
	M10x1.5	1 PC.
	3571-08	3/8" drive sliding T-handle
	3764-55G	3/8" drive mini reversible ratchet
	39123010M	3/8" tap holder

Tap Holder

3912M

- Used with reversible ratchet and T-handle
- Chuck mechanism hold compatible tap drills
- Used for metal working screw thread

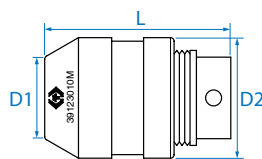
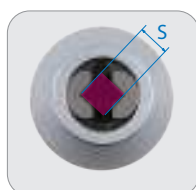

KT NO.	Drive	S(mm)		D1 mm	D2 mm	L mm	⚖️	📦	📦
		min.	max.						
new 39122008M	1/4"	2.5	5.0	9.0	20.3	30.5	52	20	200
39123010M	3/8"	2.0	6.0	23.0	34	53.0	221	4	64
39123012M	3/8"	4.0	9.0	23.0	34	53.0	223	4	64
new 39124012M	1/2"	6.0	12.0	25.3	38	52.4	265	4	64

Drill-Bit Set

11325SQ

- Material : HSS
- Metal case size (mm) :
197 x 115 x 58 (0.046 cuft)

25
PC.

Contents		⚖️ 1.23	📦 1 / 20
Drill - Bit		1, 1.5, 2, 2.5, 3, 3.5, 4, 4.5, 5, 5.5, 6, 6.5, 7, 7.5, 8, 8.5, 9, 9.5, 10, 10.5, 11, 11.5, 12, 12.5, 13	





Tap and Drill-Bit Set

11328SQ

- Material : Drill-Bit(HSS), Tap(GCr15)
- Metal case size (mm) :
195 x 115 x 57 (0.045 cuft)

28
PC.

Contents		⚖️ 1.05	📦 1 / 20
Drill - Bit		2.5, 3.3, 4.2, 5, 6.8, 8.5, 10.2	
Tap		M3x3, M4x3, M5x3, M6x3, M8x3, M10x3, M12x3	



Tap & Die Set

12916MQ1

- Material : SK5 alloy steel
- 1 PC. Tap wrench(M3-M12, 1/8"~1/2")
- 1 PC. Die stock 25mm(1")
- Tap : M3~M12
- Die : M3~M12



16 PC.

Contents		Kg 0.78	1 / 20
12939MQ-A	M3x0.5, M4x0.7, M5x0.8, M6x1.0, M8x1.25, M10x1.5, M12x1.75	25mm (1")	12939MQ-A01
12939MQ-A		M3~M12 (1/8"~1/2")	12939MQ-A02

12939MQ1

- Material : SK5 alloy steel
- 1 PC. Tap wrench(M3-M12, 1/8"~1/2")
- 1 PC. "T" Type tap wrench(M3-M6, 1/8"~1/4")
- 1 PC. Die stock 25mm(1")
- 1 PC. Screw driver
- 12939MQ1-
1 PC. Screw pitch gauge (0.5-28)
Tap : M3~M12 / Die: M3~M12
- 12939SQ1-
1 PC. Screw pitch gauge(12-40)
Tap : 1/8"~1/2" / Die : 1/8"~1/2"



12939SQ1



39 PC.

KT NO.	Contents	Kg 1.4	1 / 10
12939MQ1	12939MQ-A	12939MQ-A06 / M3x0.5, 12939MQ-A07 / M3x0.6, 12939MQ-A08 / M4x0.7, 12939MQ-A09 / M4x0.75, 12939MQ-A10 / M5x0.8, 12939MQ-A11 / M5x0.9, 12939MQ-A12 / M6x0.75, 12939MQ-A13 / M6x1.0, 12939MQ-A14 / M7x0.75, 12939MQ-A15 / M7x1.0, 12939MQ-A16 / M8x1.0, 12939MQ-A17 / M8x1.25, 12939MQ-A18 / M10x1.25, 12939MQ-A19 / M10x1.5, 12939MQ-A20 / M12x1.5, 12939MQ-A21 / M12x1.75, 12939MQ-A22 / 1/8NPT27	25mm (1") 12939MQ-A01
	12939MQ-A	12939MQ-A23 / M3x0.5, 12939MQ-A24 / M3x0.6, 12939MQ-A25 / M4x0.7, 12939MQ-A26 / M4x0.75, 12939MQ-A27 / M5x0.8, 12939MQ-A28 / M5x0.9, 12939MQ-A29 / M6x0.75, 12939MQ-A30 / M6x1.0, 12939MQ-A31 / M7x0.75, 12939MQ-A32 / M7x1.0, 12939MQ-A33 / M8x1.0, 12939MQ-A34 / M8x1.25, 12939MQ-A35 / M10x1.25, 12939MQ-A36 / M10x1.5, 12939MQ-A37 / M12x1.5, 12939MQ-A38 / M12x1.75, 12939MQ-A39 / 1/8NPT27	M3~M12 (1/8"~1/2") 12939MQ-A02
	12939MQ-A03	0.5, 0.6, 0.7, 0.75, 0.8, 0.9, 1.0, 1.25, 1.5, 1.75, 27, 28	M3~M6 (1/8"~1/4") 12939MQ-A04
12939SQ1	12939SQ-A	4NS36, 6NC32, 8NC32, 10NC24, 10NF32, 12NC24, 1/4NC20, 1/4NF28, 5/16NC18, 5/16NF24, 3/8NC16, 3/8NF24, 7/16NC14, 7/16NF20, 1/2NC13, 1/2NF20, 1/8NPT27	12939MQ-A05
	12939SQ-A03	12, 13, 14, 16, 18, 20, 24, 27, 28, 32, 36, 40	





12 KING

1200

LIGHTING







Wireless Charging Slim Lamp

9TA267W

- 10W COB + 1W SMD (Top)
- White light color, kelvin : 6500K
- Material : Nylon+PC+TPE
- 360° Adjustable base
 - +180° hiding hook + Strong magnetic base
- Rechargeable battery : 3.7V - 4500mAh Li-ion battery
- Accessory : Type-C USB charging cable
- Four leds battery indicator
- Charging time : 4 hours by charger and 6~8 hours by wireless charging base
- Can be charged with wireless charging pad 9TA92W (not included)

Switch mode	Lumen	Operating hours
Top light	100 lm	15h
One light	500+500 lm	12~6h
Two light	250~500 lm	3h

- One light source
- Both side can be lit at the same time
- 180° hiding hook
- Top light
- 360° swivel head in vertical
- Wireless charging design



KT NO.	L mm		
9TA267W	400	335	1 / 20

Contents		
Wireless Charging Slim Lamp		x 1 PC.
Type-C USB cable		x 1 PC.



Wireless charging Dual-Light Pocket Lamp

9TA44W

- 8W COB LED + 3W SMD
- White light color, kelvin : 6500K
- Dual light and spot mode, flood mode
- IP65 waterproof and dustproof, IK07 vandalproof
- 180° flexible handle + super strong magnet on the handle
- Rechargeable battery : 3.7V - 2600mAh Li-ion battery
- Accessory : Type-C USB fast charging cable
- 3 LED battery status indicators
- Charging time : 4 hours by USB cable, 6-7 hours by wireless charging base(The charging time depends on the changing power of the wireless charging base)
- Can be charged with wireless charging pad 9TA92W(not included)



RoHS

Switch mode	Lumen	Operating hours
Spot light	250 lm	4.5h
Flood light low	160 lm	10h
Flood light mid	400 lm	4.5h
Flood light high	800 lm	2.5h



• LED battery status indicators



• 180° flexible direction



• Super strong magnet on the handle



• Easy to carry



• Wireless charging design

Contents

Dual - light pocket lamp		x 1 PC.
Type-C USB cable		x 1 PC.

KT NO.	L mm		
9TA44W	97 x 83 x 39	218	1 / 24



10W Wireless Charging Flashlight

9TA71W

- Chips: High quality 10w LED, 6500K
- Switch mode:
 - Spot Light mode (Eco-Low-Mid-High)
 - Strobe mode: press and hold the switch for two seconds
- Battery: rechargeable high quality 3.7V 2600mAh Li-ion
- Charging time: 4 hours by charger and 6~8 hours by wireless charging base (The specific charging time depends on the power of the charging base)
- IP68 waterproof and IK07 vandalproof
- Features:
 - Wireless charging function
 - Super strong magnets on the light
 - Three LED battery indicators show the charging and working
- Working temperature: -10°C to +40°C
- Accessory: type-C fast charging cable
- Can be charged with wireless charging pad 9TA92W

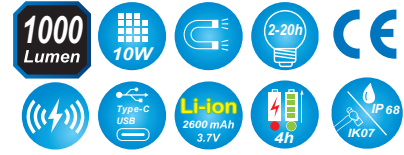

RoHS



Switch mode	Lumen	Operating hours
Spot light eco	5 lm	200h
Spot light low	30 lm	25h
Spot light mid	400 lm	4h
Spot light high	1000 lm	2h



• Main switch



• Type-C USB charger port



• Wireless charging



• Hanging hole



• Press and hold the switch for two seconds



• Super strong magnets on the light

KT NO.	L mm	g	Box
9TA71W	160	215	1 / 24

Contents

Flashlight		x 1 PC.
Type-C USB cable		x 1 PC.

Wireless Charging Pad

9TA92W

- Output power: 5W
- IP20 waterproof and IK07 vandalproof
- Features:
 - Built-in screw holes for wall mounting
 - Super strong magnets in the front and back
 - LED battery indicator shows the charging and working
- Working temperature: -10°C to +40°C
- Accessory: Type-C charging cable and 5V1A USB adapter
- Can be used by wireless charging light 9TA267W/9TA44W/9TA71W

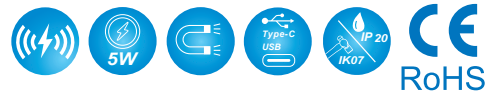

RoHS

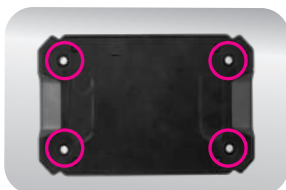

• Built-in screw holes for wall mounting

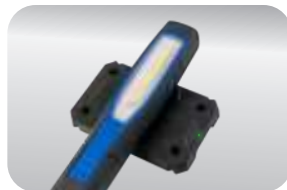

• LED battery indicator shows the charging and working

KT NO.	Applicable area	L mm	g	Box
9TA92WA	Europe	335	1 / 12	
9TA92WB	America & Asia	164	335	1 / 12
9TA92WD	Australia & New Zealand	335	1 / 12	

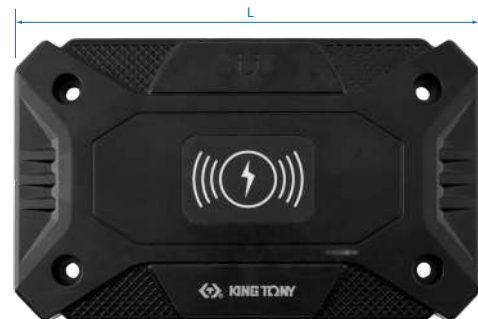

Contents

5W output charger base		x 1 PC.
Type-C USB cable		x 1 PC.
5V1A USB charger		x 1 PC.



INSPECTION LIGHTS

7W+4W Inspection Light

9TA242

- Chips:
 - High quality 7W COB LED,6500K
 - High quality 4W SMD LED,6500K
- Switch mode: Top Torch-Main Light(Low-Mid-High)-Off
- Battery: rechargeable high quality 3.7V 2600mAh Li-ion
- Charging time: 4hr by charger
- IP65 waterproof and IK07 vandalproof
- Features:
 - 180° swivel base+Two 360° functional hooks
 - Two super strong magnets on the back and one on the base
 - Three LED battery indicators show the charging and working
- Working temperature: -10°C to + 40°C
- Accessory:Type-C USB Charging cable and 5V 1A USB charger



Switch mode	Lumen	Operating hours
Top light	200 lm	5h
Main light low	150 lm	8h
Main light mid	350 lm	4h
Main light high	700 lm	2h

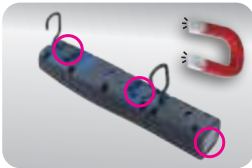

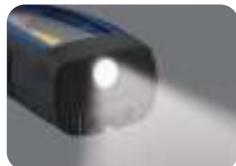
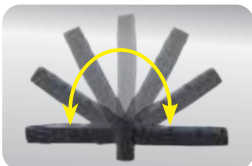

- Two super strong magnets on the back and one on the base
- Two 360° functional hooks
- Type-C USB charger port



KT NO.	Applicable area	L mm	g	Icons
9TA242A	Europe	260	516	1 / 12
9TA242B	America & Asia	260	516	1 / 12
9TA242D	Australia & New Zealand	260	516	1 / 12

Contents

Inspection lamp		x 1 PC.
Type-C USB cable		x 1 PC.
USB charger		x 1 PC.



6W COB +1W SMD Slim Inspection Lamp

9TA261

- 6W COB + 1W SMD (Top)
- White light color, kelvin : 6500K
- IP54 waterproof and dustproof, IK07 vandalproof
- Materials : ABS plastic + rubber housing + PC lens + aluminium slim housing
- 120° Angle rotation & magnetic base
- Rechargeable battery : 3.7V - 2600mAh Li-ion
- Switch modes : Top light – Worklight low-Worklight high-Off
- Accessory : Type-C USB Charging cable and 5V 1A USB charger
- Charging time : 4 hours

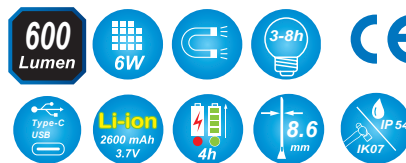

Switch mode	Lumen	Operating hours
Top light	120 lm	8h
Main light low	250 lm	6h
Main light high	600 lm	3h

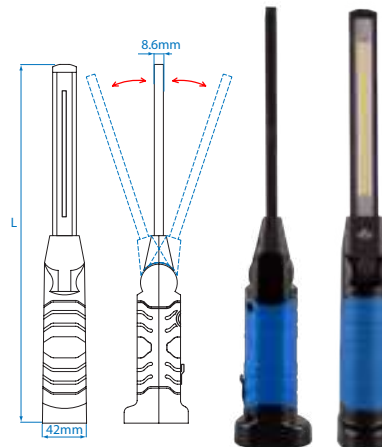

KT NO.	Applicable area	L mm	g	Box
9TA261A	Europe	340	300	1 / 12
9TA261B	America & Asia	340	300	1 / 12
9TA261D	Australia & New Zealand	340	300	1 / 12

Contents

COB LED lamp		x 1 PC.
USB charger		x 1 PC.
Type-C USB cable		x 1 PC.

Aluminum Folding Slim Lamp

9TA268

- White light color, kelvin : 6500K
- Material : PA + Rubber + Aluminum housing
- 180°swivel head in vertical + Strong magnetic base
- Rechargeable battery : 3.7V - 2600mAh Li-ion battery
- Accessory : Type-C USB Charging cable and 5V 1A USB charger
- Three leds battery indicator / Charging time : 4 hours



Switch mode	Lumen	Operating hours
Top light	120 lm	8h
Main light low	150 lm	8h
Main light high	800 lm	2.5h
Minor light low	120 lm	9h
Minor light high	400 lm	4h



- Super strong magnets on the bottom
- Top light
- Three leds battery indicator
- 180°swivel head in vertical

KT NO.	Applicable area	L mm	g	Box
9TA268A	Europe	200	193	1 / 40
9TA268B	America & Asia	200	193	1 / 40
9TA268D	Australia & New Zealand	200	193	1 / 40

Contents

Pro Aluminium Rechargeable Slimlight		x 1 PC.
Type-C USB cable		x 1 PC.
Charger		x 1 PC.



Flexible LED Slim Light

9TA251

- 5W COB + 3W SMD (Top)
- White light color, kelvin : 6000K~6500K
- IP54 waterproof and dustproof, IK07 vandalproof
- Material : PA + TPE housing
- Flexible Gooseneck + 90° hiding hook + Strong magnetic base
- Rechargeable battery : 3.7V - 2600mAh Li-ion battery
- Accessory : Type-C USB Charging cable and 5V 1A USB charger
- Three leds battery indicator
- Charging time : 4 hours



Switch mode	Lumen	Operating hours
Top light	120 lm	9h
Main light Min ~ Max	50~500 lm	16~2h



- Top SMD
- USB charger port + battery indicator
- Strong magnetic + 90° Hook
- Stepless Dimmer Switch

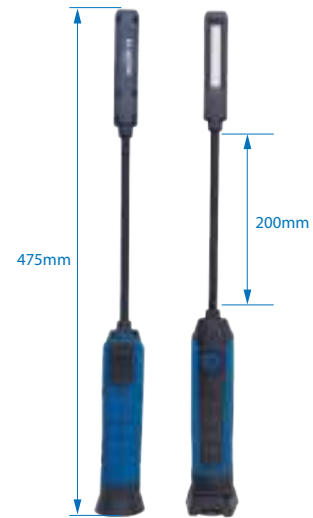

KT NO.	Applicable area	L mm	g	Box
9TA251A	Europe	475	322	1 / 12
9TA251B	America & Asia	475	322	1 / 12
9TA251D	Australia & New Zealand	475	322	1 / 12

Contents

Flexible slim lamp		x 1 PC.
USB charger		x 1 PC.
Type-C USB cable		x 1 PC.



10W COB LED Adjustable Lamp

9TA33

- White color, kelvin : 6500K
- Two steps adjustable light
- Material : ABS + PC
- IP20 waterproof and dustproof, IK07 vandalproof
- 170° magnetic swivel base + 360° body swivel knot + two 360° functional hooks
- Rechargeable battery : 7.4V - 2600mAh Li-ion
- Accessory : Type-C USB Charging cable and 5V 1A USB charger
- Charging time : 4.5 hours



Switch mode	Lumen	Operating hours
Low light	400 lm	5.5h
High light	1000 lm	2.2h



• 170° swivel base • Two steps adjustable light



• Magnetic swivel base • body swivel knot



Contents

10W COB LED adjustable lamp		x 1 PC.
USB charger		x 1 PC.
Type-C USB cable		x 1 PC.

KT NO.	Applicable area	L mm	g	kg	Box
9TA33A	Europe	500	487	1 / 12	
9TA33B	America & Asia	500	487	1 / 12	
9TA33D	Australia & New Zealand	500	487	1 / 12	

LED Rechargeable Underhood Light

9TA34

- 20W SMD
- White color, 50x Super bright SMD LED, 6500K
- Material : Aluminum body + PA
- IP20 waterproof and dustproof, IK07 vandalproof
- Features : Durable housing, Hooks with Rubber, and lens 3 leds battery level indicator
- Battery: 3.6V4800mAh Li-ion battery with Type-C USB socket
- Accessory: Type-C USB Charging cable and 5V 2A USB charger
- Charging time : 4 hours



Switch mode	Lumen	Operating hours
Low light	500 lm	6.5h
Mid light	1000 lm	4h
High light	2000 lm	2h

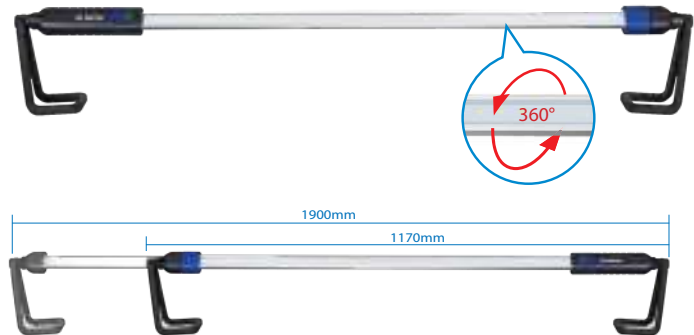

KT NO.	Applicable area	L mm	g	kg	Box
9TA34A	Europe	1170	1666	1 / 6	
9TA34B	America & Asia	1170	1666	1 / 6	
9TA34D	Australia & New Zealand	1170	1666	1 / 6	
9TA34P01	3.6V4800mAh	70	1 / 1		

Contents

360° Rotational Bar		x 1 PC.
5V/2A charger		x 1 PC.
Type-C USB		x 1 PC.
4800mAh Battery		x 1 PC.



HEAD TORCHES

Lightweight Rechargeable Neck Light

9TA54

- White light color, kelvin : 6500K
- IP54 waterproof and dustproof, IK07 vandalproof
- Features:
The Neck light is lightweight, adjustable and comfortable around your neck
The 2 light head can be adjusted independently up to 120° for a wider Lighting
Circuit protection prevents battery from over-charging or over-discharging
- Rechargeable battery : Rechargeable high quality 3.7V 700mAh Li-ion
- 3 colors LED battery level indicator show the battery level
Red Blinking: Low battery power warning
Green Blinking: charging
Green: Fully charged
- Charging time : 2.5 hours
- Temperature: -10°C to +40

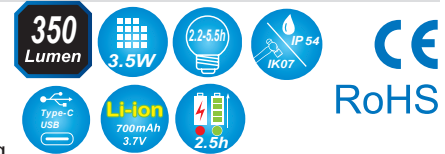

Switch mode	Lumen	Operating hours
Low light	180 lm	5.5h
High light	350 lm	2.2h



- Lightweight, adjustable, comfortable
- 3 Colors LED indicator
- 120° Adjustable light head
- Type - C USB port

KT NO.	L mm	Weight	Quantity
9TA54	230 x 130 x 45	140	1 / 12

Contents

Lightweight Rechargeable Neck Light		x 1 PC.
Type-C USB cable		x 1 PC.

Rechargeable LED Beanie Hat

9TA56

- Made of 100% acrylic, help you resist the cold wind, keep your head and ear warm
- Elastic material, fits for most of head circumference
- 3.7V 250mAh rechargeable Li-Polymer battery
- 4 built-in LED bulbs with 3 adjustable brightness level
- With reflective strip to make you easily be noticed in the dark
- Suitable for all kinds of outdoor activities
- Charging time : 2 hours



- Simply pop it out and charge it



Switch mode	Lumen	Operating hours
Low light	30 lm	6h
Mid light	60 lm	4h
High light	170 lm	2h



- Socket
- Laptop
- Car Charger
- Power Bank



- reflective strip



3W COB LED Inductive Head Lamp

9TA52

- White light color, kelvin : 6500K
- IP65 waterproof and dustproof
- Materials : High impact ABS + TPE housing + PC lens & non-skid grip belt
- Feature : 10cm Smart motion sensor
- Rechargeable battery : 3.7V - 1500mAh Li-po
- LED battery charging indicator
- Charging time : 2.5 hours
- Accessory : Type-C USB Charging cable and 5V 1A USB charger



Switch mode	Lumen	Operating hours
Low light	100 lm	5.5h
High light	280 lm	2h



• Two step adjustable light



• 60° Adjustable lighting



• Inductive indicator ON



• Inductive light switch

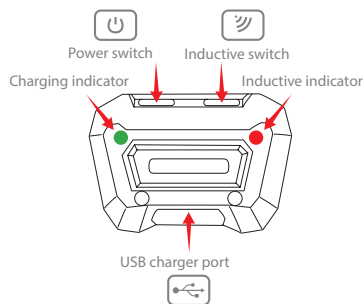

KT NO.	Applicable area	L mm	g	mm	kg
9TA52A	Europe	65	110	1 / 40	
9TA52B	America & Asia	65	110	1 / 40	
9TA52D	Australia & New Zealand	65	110	1 / 40	

Contents

COB LED lamp		x 1 PC.
Headband		x 1 PC.
USB charger		x 1 PC.
Type-C USB cable		x 1 PC.

Twin-Beam Multifunctional Head Lamp

9TA53

- White light color, kelvin: 6500K
- Dual light mode, spot mode, flood mode
- IP65 waterproof and IK07 dustproof
- Materials : High impact ABS + PC housing + PC lens & non-skid grip belt
- Feature : 10 cm Smart motion sensor + 60° adjustment
- Battery : AAA alkaline battery (included)

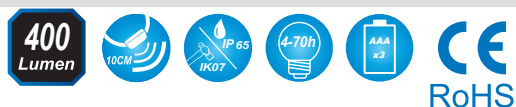

Switch mode	Lumen	Operating hours
Spot light	20~400 lm	60~5h
Flood light	20~200 lm	60~4h
Red LED	0.5~20lm	70~10h
SOS light	strobe	



• Inductive light switch



• 60° Adjustable lighting



• Strobe for signaling



KT NO.	L mm	g	mm	kg
9TA53	68.8	89	1 / 12	

Contents

COB LED lamp		x 1 PC.
Headband		x 1 PC.
AAA alkaline battery		x 3 PC.



FLASHLIGHTS

1.5W COB +1 LED Lamp

9TA28

- 1.5W COB + 1W LED
- 180° magnetic swivel base + 270° magnetic swivel clip
- Rechargeable battery : 3.7V - 800mAh Li-ion
- Accessory : Type-C USB Charging cable
- Overcharge/Discharge protection
- Materials : ABS+PC
- Charging time : 2 hours
- White light color, kelvin : 7200K



Switch mode	Lumen	Operating hours
Top light	80 lm	3.5h
Main light	145 lm	2h



• magnetic base



• USB charger port



• Top light with 1 LED

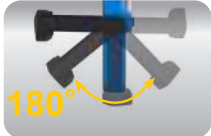

• 180° swivel clip

KT NO.	L mm	g	Box
9TA28	180	160	12 / 48

9TA28 180 160 12 / 48

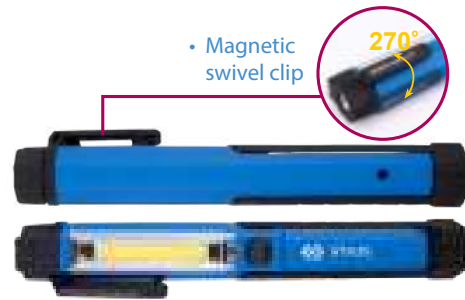

• Magnetic swivel clip

Contents

1.5W COB + 1 LED rechargeable work lamp		x 1 PC.
Type-C USB cable		x 1 PC.

Rechargeable LED Pen Light

9TA281

- 3.5W -7 SMD + 1W SMD (Top)
- White light color, kelvin : 6500K
- IP20 waterproof and dustproof, IK07 vandalproof
- Material : ABS housing + Rubberized painting + PC lens
- Strong magnet on the clip
- Rechargeable battery : 3.7V 750mAh Li-ion
- Led charging indicator : Red -Charging, Green -Fulled
- Charging time : 2 hours
- Accessory : Type-C USB Charging cable

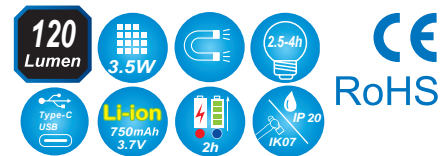

Switch mode	Lumen	Operating hours
Top light	80 lm	4h
Main light	120 lm	2.5h



KT NO.



L mm



g

Box

9TA281 170 58 1 / 48



Contents

LED pen light		x 1 PC.
Type-C USB cable		x 1 PC.



LED Pocket Torch

79815

- 3W High performance LED adjustable focus pocket torch
- Strobe warning lights for maximize visibility
- Aluminum alloy body, safety lanyard included
- Operates using 3 x AAA batteries (not included)



Switch mode	Lumen	Operating hours
Main light	120 lm	6.5h



KT NO.	L x Ø mm	g	Box / Carton
79815	128 x 28	95	1 / 100

LED Pen Light

79831

- Pen light with 6 PC. SMD(surface-mount devices) LED
- ABS body 360 degree rotation
- PE lampshade : avoid nebulization
- Operates using 3 x AAA batteries (not included)



Switch mode	Lumen	Operating hours
Main light	135 lm	5.5h



KT NO.	L x W x H mm	g	Box / Carton
79831	165 x 25 x 30	58	10 / 120

LED Telescopic Torch

79833

- 3 LEDs, white light color
- Magnetic torch with 360° flexible head
- Extends up from 170mm to 560mm
- 4 x LR44 batteries included



KT NO.	L x Ø mm	g	Box / Carton
79833	170 x 22	100	10 / 120

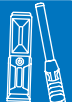



30W Wired COB LED Site Light

9TA42

- 30W COB LED floodlight with portable handle
- White light color, kelvin : 6000~7000K
- Pass IP54 test
- Slim profile with lockable adjustment and 180° swivel base
- Option to wall mount or tripod stand at work sites
- Accessory : AC adapter cable 1.8M

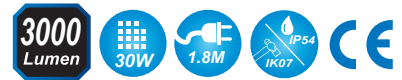

Switch mode	Lumen
Main light	3000 lm



• Swivel base

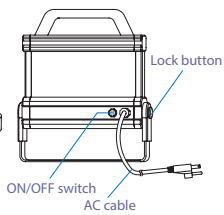
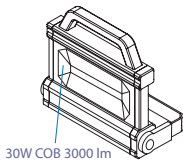

KT NO.	Applicable area	L x H x W mm			
9TA42A	Europe	238 x 270 x 46	1239	1	6
9TA42B	America & Asia	238 x 270 x 46	1239	1	6
9TA42D	Australia & New Zealand	238 x 270 x 46	1239	1	6



45W Twin Head SMD Site Light

9TA45

- 45W 120 PC. SMD LED
- White light color, kelvin : 5700K
- 90° vertical rotation & 180° horizontal rotation for angle of lighting
- Rechargeable battery : Replaceable 14.8V 5200 mAh Li-ion battery pack
- Accessory : 100-240V to 20V 1.1A charger
- 5 LED battery status indicator & USB 5V 2A output
- Charging time : 4.5 hours
- Material : PA + ABS + PC



Switch mode	Lumen	Operating hours
Work light 25%	750 lm	12h
Work light 50%	1500 lm	6h
Work light 75%	3000 lm	3h
Work light 100%	4500 lm	2h



- 180° horizontal rotation
- 90° vertical rotation
- Replaceable battery



- Power bank in case of emergency
- Anti-slip handle
- Option to fixation

KT NO.	Applicable area	L x W x H mm	Weight (kg)	Dimensions (mm)
9TA45A	Europe	288 x 176 x 131	2140	1 / 4



Contents

45W Twin Head SMD Site Light		x 1 PC.
AC charger		x 1 PC.
Battery pack		x 1 PC.

40W COB Bluetooth Speaker Site Light

9TA46

- 40W COB LED
- White light color, kelvin : 6500K
- 140° vertical rotation + hiding hook on the bottom
- High performance integrated 10W Bluetooth speaker
- Rechargeable battery : 11.1V 5200 mAh Li-ion
- Accessory : 100-240V to 15V 1.5A charger
- 5 LED battery status indicator & USB 5V 2A out put
- 1 LED Bluetooth indicator
- Quick charging time : 3.5 hours
- Material : TPE + PA + aluminum + PC



Switch mode	Lumen	Operating hours
Eco light	400 lm	20h
Full power light	4000 lm	2h
Music mode	-	5~8h



- AC Charger
- Bluetooth on & battery indicator
- Anti-slip handle



- Option to fixation
- Hiding Hook
- 140° vertical rotation

KT NO.	Applicable area	L x W x H mm	Weight (kg)	Dimensions (mm)
9TA46A	Europe	210 x 210 x 100	1450	1 / 4



Bluetooth 4.0 10M

Contents

40W COB Bluetooth Speaker Site Light		x 1 PC.
AC charger		x 1 PC.

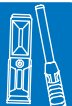

ACCESSORIES



Adjustable Tripod for Site Light

87162

- Can hold one light or 2 lights (with T-Bar)
- Durable heavy duty steel tripod body
- Three section tube diameter : 25mm / 32mm / 38mm
- Adjustable tripod height from 700mm to 1500mm
- Portable, easy to fold and great for transportation
- It is recommended to use with 9TA42 / 9TA45 / 9TA46 / 9TA48 (This product dose not contain lamps, please buy separately)

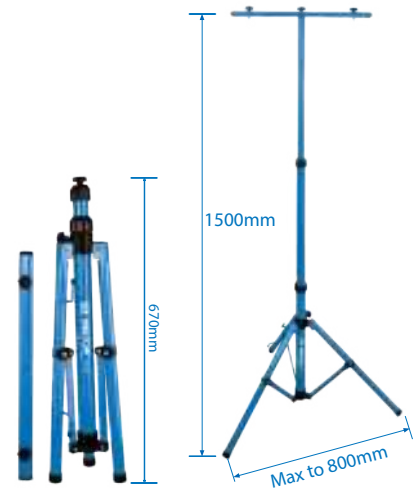

KT NO.	Tube Diameter (mm)	Loading Weight (kg)	Folded Length (mm)	Max height (mm)	⚖️	📦
87162	38	3.0	700	1500	650	1 / 6

Detachable Underhood Light Shelf

87163

- Two movable base fit all kinds of magnetic lights
- 360° horizontal rotating base for different lighting angle
- Three section length adjustment fit variety of occasions
- Durable heavy duty aluminum body + PA
- Anti-sliding clasp handle
- It is recommended to use with 9TA44W (This product dose not contain lamps, please buy separately)

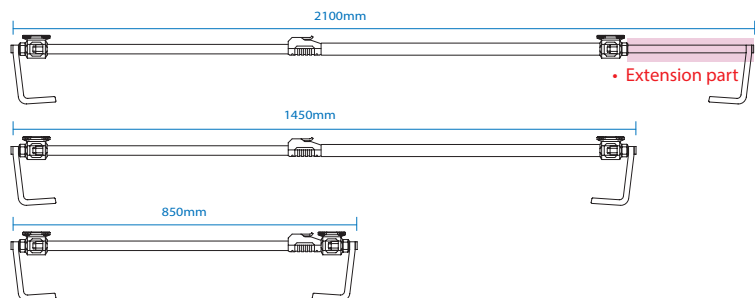

- Three section length adjustment fit variety of occasions
- 360° horizontal rotating base for different lighting angle

KT NO.	Width (mm)	Height (mm)	Folding length (mm)	Extendable length (mm)	⚖️	📦
87163	110	180	850	2100	1300	1 / 6



AUTOMOTIVE TOOLS





Tool Trolley Contents

286
PC.



Contents No. 934-010MRVD

28.8 KG 2.97 CUFT

- Special tool set for Automobile, suitable for VOLKSWAGEN-GROUP, MERCEDES-BENZ, OPEL, BMW & Japanese passenger car



9-3544MRV #9 P.79

9-4537MRV #9 P.80

9-4147PRV
#10 P.88

9-4401MPV
#10 P.88

9-2565MRV #7 P.76
9-4129PRV #7 P.77

9-90119MRV #9 P.82

9-1220MRV #9 P.81

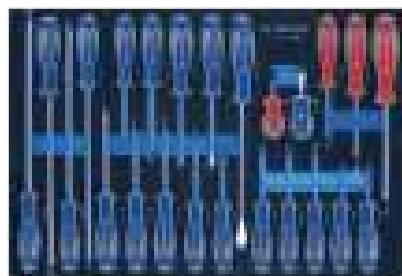

9-31124MRV #6 P.122



9-40104GPV
#10 P.88

9-40113GPV
#10 P.88

9-90135MRV
#10 P.88

9-90118PRV
#10 P.89



Tool Trolley Set

286
PC.



92.8
CUFT 15.21



934-010MRV
(87434-7B P.37)



934-010MRV-G
(87434-7B-G P.37)



934-010MRV-B
(87434-7B-B P.37)



98.8
CUFT 15.21



9634-010MRV
(87634-7B P.39)



9634-010MRV-G
(87634-7B-G P.39)



9634-010MRV-B
(87634-7B-B P.39)



ALFA ROMEO

Diesel Engine Setting & Locking Set



9AT2006E

- The set includes flywheel holding tool, crankshaft locking tool and camshaft setting tools
- Suitable for Lancia, Alfa Romeo and Fiat engine
- Use to set and lock engine timing



1360 1 / 10

MODEL:

145 (98-01), 146 (98-01), 147 (01-09)
156 (97-08), 159 (05-09), 166 (98-08)
GT (04-09), Brera (05-09), Spider (06-09)
Crosswagon (04-08)

ENGINE CODE:

1.9JTD 8v.
323.02, 371.01, 182B9.000, 937A2.000
937A3.000, 939A1.000, 939A2.000,
939A7.000
1.9JTD 16v.
192A5.000, 192B1.000, 937A4.000
937A5.000, 939A2.000, 939A8.000
2.4JTD 10v.
325.01, 342.02, 362.02, 839A6.000
841C.000
2.4JTD 20v.
841G.000, 841H.000, 841M.000
939A3.000, 939A9.000

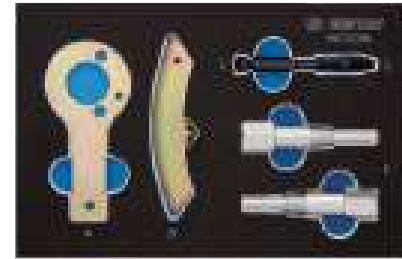
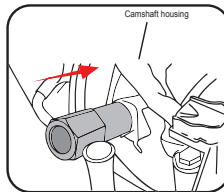
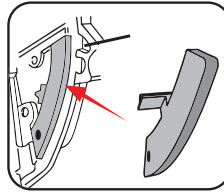

CONTENTS :

- A&C&D - crankshaft locking tool
- B - flywheel holding tool (crank pulley removal)
- E - camshaft setting tool (pair)

BMW

Petrol Engine Twin Camshaft Setting & Locking Set

9AT1018E

- The set includes camshaft / carrier bracket remover & installer tools
- Suitable for BMW petrol 1.8 and 2.0 N42 / N46 (chain) engine



4400 1 / 3

MODEL:

118i. E87 (04-08)
120i. E87 (04-08)
316i. E46 (01-05)
316ti. Compact E46 (01-05)
318i. E46 (01-07)
318ti. Compact E46 (01-05)
318i. E90 (05-08)
X3. 2.0i E83 (05-08)
Z4. 2.0i E85 (04-08)
520i. E60 (04-08)
320i. E90 (05-08)

ENGINE CODE:

N42 / N46
B18, B18A, B20, B20A, B20B

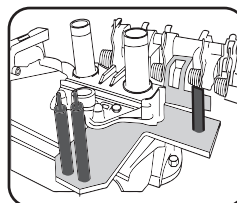
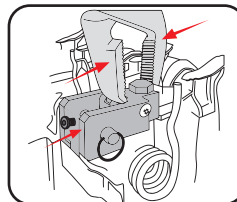

CONTENTS :

- A&H&I - camshaft/carrier bracket
- Mounting fixture
- B - inlet camshaft securing tool (rear)
- C&F - torsion spring remover/installer
- D&E - inlet camshaft securing tool (front)
- G - intermediate lever clamp set (8 PC.)





9AT1009E

- The set includes compressed air connector, twin VANOS setting tool and sprocket / chain assembly fixture, timing adjustment plate, pre-load tools
- Suitable for setting / locking popular BMW petrol engine
- Use to adjust engine timing and set / lock engine application



5966 1/3

MODEL:

318is. E36 (92-99)
 318ti Compact E36 (94-01)
 320i. E36 / E46 (92-07)
 323i. E36 / E46 (95-01)
 325i. E36 / (92-07)
 328i. E36 / E46 (95-01)
 330i. E46 (00-07)
 520i. E39 / E60 (96-05)
 523i. E39 (96-00)
 525i. E39 / E60 (00-05)
 528i. E39 (96-00)
 530i. E39 / E60 (00-05)
 728i. E38 (94-02)
 730i. E65 (02-05)
 Z3. (E36) 1.9-3.0 (96-03)
 Z4. (E85) 2.2-3.0 (03-06)
 X3. (E83) 3.0 (03-06)
 X5. (E53) 3.0 (99-07)

CONTENTS :

- A - camshaft setting plate
- B - timing adjustment plate
- C - compressed air connector
- D - sprocket / chain assembly fixture
- E - flywheel locking pin
- F - tensioner pin (M50)
- G - twin VANOS setting tool
- H - tensioner pin (M52)
- I - tensioner tool

ENGINE CODE:

M42 / M44 / M50 / M52
 no VANOS (VVT)
 18 4S 1, 19 4S 1, 20 6S 2(Early),
 25 6S 2(Early)
 M50 / M52
 Single VANOS (VVT) variants
 20 6S 2(Later)
 20 6S 3
 25 6S 2(Later)
 M52(TU) / M54 / M56
 Twin VANOS (VVT) variants
 20 6S 4
 22 6S 1
 25 6S 4

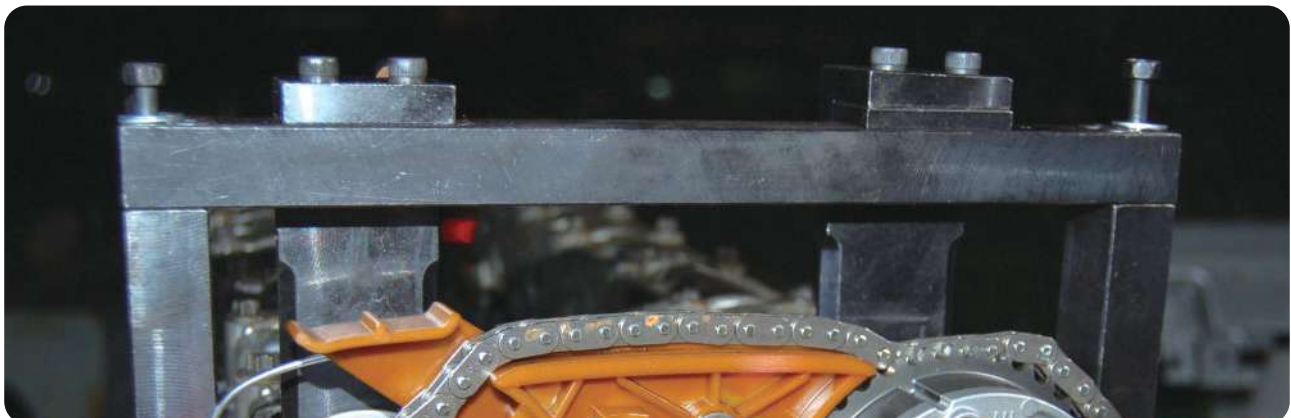
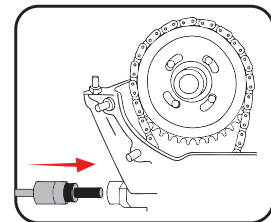
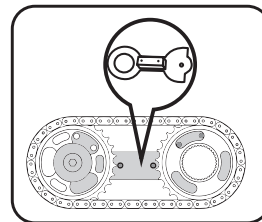
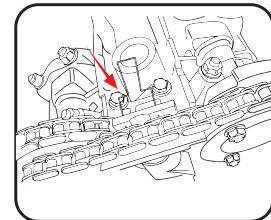
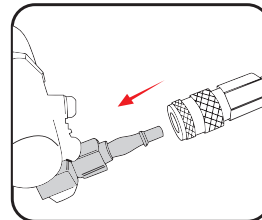
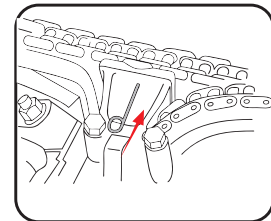
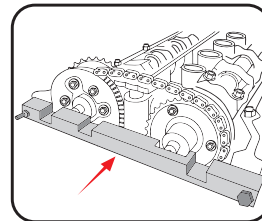

BMW

Petrol Engine Twin Camshaft Setting & Locking Set



9AT1102E

- The set includes camshaft locking plate and flywheel locking pin
- Suitable for M40 engines (also used on the M43 chain driven engine)
- Use to lock the camshaft and crankshaft TDC position to keep their timing relationship while replacing timing belt or carry out other timing belt service



1901 1 / 10

MODEL: 316i E36 / E46 (93-04)
 316i Compact E36 / E46 (98-01)
 318i E36 / E46 (93-01)
 518i E34 (94-96)
 Z3 1.8 / 1.9 E36 (96-03)

ENGINE CODE: M43
 16 4E 2, 16 4E 3
 18 4E 2, 19 4E1

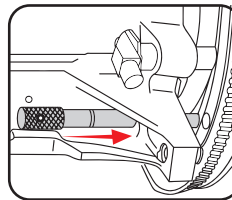
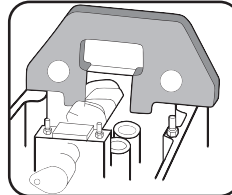

CONTENTS :
 • A - camshaft locking plate
 • B - flywheel locking pin

BMW

Petrol Engine 1.8 To 3.0 Twin Cams Setting & Locking Set



9AT1106E

- The set includes camshaft setting plate, timing adjustment plate, pre-load tool, flywheel locking pin and tensioner pin
- Suitable for setting / locking popular BMW petrol engine
- Suggestion:
 Use with 9AT1-A02 wrench while using this kit on SINGLE VANOS system (on inlet camshaft)
 Use with 9AT1303 while using this set on TWIN VANOS system



3781 1 / 5

MODEL:	318is. E36 (92-99)	525i. E39 / E60 (00-05)
	318ti Compact E36 (94-01)	528i. E39 (96-00)
	320i. E36 / E46 (92-07)	530i. E39 / E60 (00-05)
	323i. E36 / E46 (95-01)	728i. E38 (94-02)
	325i. E36 / E46 (92-07)	730i. E65 (02-05)
	328i. E36 / E46 (95-01)	Z3. (E36) 1.9-3.0 (96-03)
	330i. E46 (00-07)	Z4. (E85) 2.2-3.0 (03-06)
	520i. E39 / E60 (96-05)	X3. (E83) 3.0 (03-06)
	523i. E39 (96-00)	X5. (E53) 3.0 (99-07)

ENGINE CODE: M42 / M44 / M50 / M52 no VANOS (VVT)
 18 4S 1, 19 4S 1, 20 6S 2(Early), 25 6S 2(Early).
 M50 / M52 Single VANOS (VVT) variants
 20 6S 2(Later), 20 6S 3, 25 6S 2(Later),
 25 6S 3, 28 6S 1
 M52(TU) / M54 / M56 Twin VANOS (VVT) variants
 20 6S 4, 22 6S 1, 25 6S 4, 25 6S 5, 28 6S 2, 30 6S 3



CONTENTS :
 • A - camshaft setting plate
 • B - timing adjustment plate
 • C - flywheel locking pin
 • D - tensioner pin (M50)
 • E - tensioner pin (M52)
 • F - tensioner tool

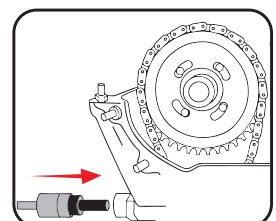
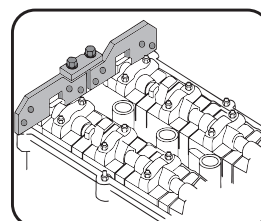
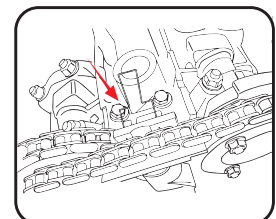
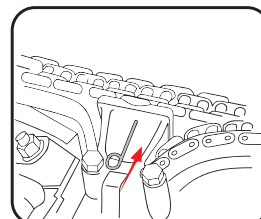

ENGINE SERIES



KING TONY

BMW

Petrol Engine Timing Setting & Locking Set



9AT1206E

- The set includes VANOS alignment plate, camshaft setting tools, flywheel locking pin and timing chain tensioner pre-load tool
- Suitable for 1.6 BMW, 4 cylinder twin camshaft 16v and chain driven petrol engines with VANOS
- Use to check and adjust engine timing



2657 1 / 5

MODEL: 116i, E81 E87 (03-09)
316i, E46 / E90 (01-08)
316Ci, E46 (01-06)
316ti, E46 (01-05)

ENGINE CODE: N40 / N45 / N45T
B16, B16A, B16AC

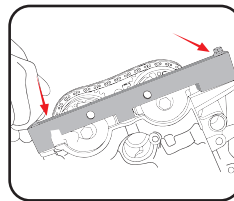
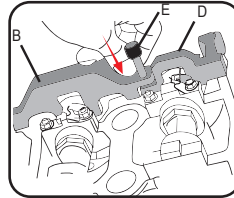

CONTENTS :

- A - VANOS alignment plate
- B - camshaft setting plate (inlet)
- C - timing chain tensioner pre-load tool
- D - camshaft setting plate (exhaust)
- E - camshaft setting plate securing screw
- F - flywheel locking pin

BMW

Diesel Engine 2.5TDS Timing Set



9AT2106E

- The set includes camshaft setting plate, tensioner lever, tensioner retaining pin, flywheel locking pin and pump remove & sprocket retainer
- Suitable for BMW, Land Rover and Opel engine
- Use to retain and support the sprocket and timing chains in correct position when the pump is removed



2480 1 / 5

MODEL: 1.7 2.5td / tds (Chain)
318tds, E36(94-00)
325td / tds, E36(91-99)
525td / tds, E34(90-00)
725tds, E38(95-02)

ENGINE CODE: 1.7 2.5td / tds (Chain)
M41 / M51

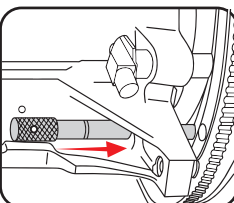
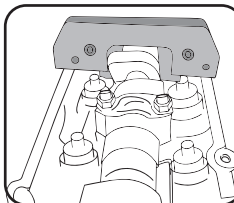

CONTENTS :

- A - camshaft setting plate
- B - tensioner lever
- C - flywheel locking pin
- D - tensioner retaining pin
- E - pump remove & sprocket retainer (2 part)

ENGINE SERIES



BMW/ MINI

Petrol Engine Setting & Locking Set – BMW/PSA

9AT1010E

- The set includes camshaft setting tool, crankshaft locking pin & chain tensioner tool
- Suitable for BMW Mini and PSA Peugeot Citroën 1.4/1.6 16v valvetronic direct injection engines
- Use to lock and adjust engine timing



BMW Mini Cooper N12/N14 2384 / 1 / 5

MODEL: Clubman(07-14)
Countryman(14-16)
Paceman(14-16)
Roadster(12-12)

ENGINE CODE: N12 1.4/1.6(Valvetronic)
B14, B14AB, B16A
N14 1.6(Direct Injection)
B16A, B16CD/TD, B16TD, B16CD

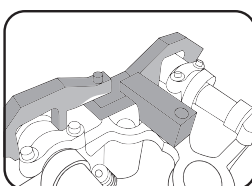
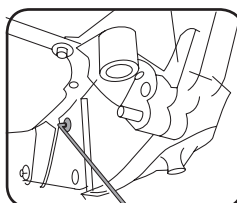

CONTENTS :

- A – camshaft setting tool (inlet)
- B – camshaft setting tool (exhaust)
- C – camshaft setting tool
- D – camshaft setting clamp
- E – crankshaft locking pin
- F – chain tensioner tool
- G – M10 screw*4

BMW/ MINI

Petrol Engine Timing Set

9AT1108E

- Use for BMW & Mini 1.6 litre chain drive petrol engine
- Includes the cam & crankshaft locking tools and chain pre-tension setting tools for TDC position
- Suitable for BMW (N13) & Mini (N18) engines



2527 / 1 / 10

MODEL: **BMW 1 Series**
114i F20(2012-15), 116i F20 (2012-15),
118i F20 (2011-15)
BMW 3 Series
316i F30 (2012-15)
MINI
Cooper S (R56/57) (2010-15)
Coupe Cooper S (R58) (2012-15)
Roadster (R59) (2012-15)
Countryman (R60) (2012-16)
Paceman (R61) (2013-16)
Clubman (R55) (2011-14)

ENGINE CODE: **N13**
B16A
N18
B16/M0, B16A, B16A/M0, B16A/MO, B16C,
B16C/TO, B16M0



CONTENTS :

- A – camshaft locking tool
- B – camshaft locking tool
- C – chain tensioner tool
- D – crankshaft locking pin



Diesel Engine Timing Locking Set



9AT2107E

- The set includes camshaft alignment tool, flywheel locking tool, crankshaft pulley turning tool, and also high pressure pump sprocket removal tool
- Suitable for BMW N47 / N47S / N57 2.0 and 3.0 twin camshaft diesel chain drive engine
- Use to set & lock the camshaft and crankshaft when adjusting valve timing on engine correctly



1730 1 / 10

MODEL:

1 Series
116d/118d/120d/123d
E81/82/87/88 (07-12)

3 Series
316d/318d/320d/325d/330d/330xd
E90/91/92/93 (07-12)

5 Series
520d E60/61 (07-10)
525d/530d/535d F10/11 (10-12)
530d GT/535d GT F07 (09-12)

7 Series
730d/730Ld/740d/740d xDrive
F01/02/04 (08-12)

X Series
X1 sDrive 18d/20d E84 (09-12)
X1 xDrive 18d/20d/23d E84 (09-12)
X3 20d E83 (07-10)
X3 xDrive 1.8d/30d E83 (08-12)
X5 30d/xDrive 40d E70 (10-12)
X6 xDrive 30d/40d E71/72 (10-12)

ENGINE CODE:

N47 / N47S
D20A
D20B
D20T0
D20O0
D20U0

N57
D30U0
D30O0
D30O1
D30T0



CONTENTS :

- A – camshaft Alignment Tool
- B – flywheel Locking Tool
- C – crankshaft Turning Tool
- D/F – high pressure pump sprocket removal tool
- E – tensioner Locking Pin

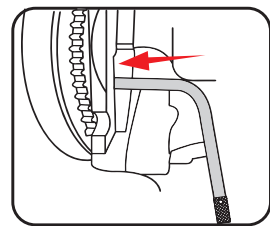
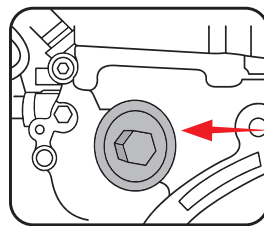
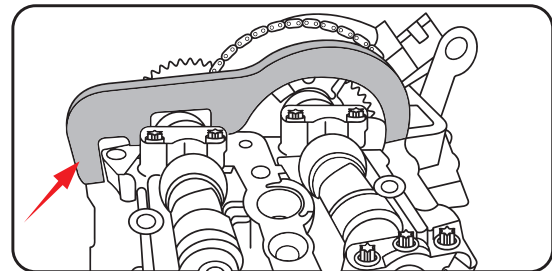

BMW

Petrol Engine Timing Set



9AT1706E

- Use for BMW 2.0 litre chain drive petrol engine
- Includes the VANOS setting tools, camshaft locking tools and chain pre-tension setting tools for TDC position
- Suitable for BMW N20 & N26 engines



4287 1 / 3

BMW 1 Series
125i F20/21(2012-14)

BMW 3 Series
320i/xDrive F30/31 (2012-14),
328i F30/31 (2012-14),
328i/xDrive F30/31 (2012-14)

BMW 5 Series
520i F10/11 (2010-14), 528i F10/11 (2013-14),
528i/xDrive F10/11 (2011-14)

X1
sDrive18i/20i E84 (2011-14),
xDrive20i/28i E84 (2011-14)

X3
xDrive20i/28i F25 (2011-14)

Z4
sDrive18i E89 (2013-14),
sDrive20i/28i E89 (2011-14)

MODEL:

ENGINE CODE: N20 B20A, N20 B20B/UO, N20 B20OO, N26 B20

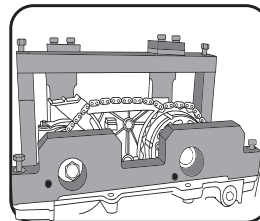
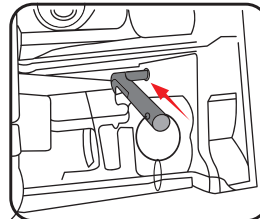

CONTENTS :

- A - VANOS alignments plate
- B - camshaft locking tool
- C - chain tensioner tool
- D - flywheel locking pin

MERCEDES-BENZ

Petrol Engine Timing Set



9AT1606E

- Use for 1.8 litre M271 chain drive petrol engine
- Includes chain tensioner adjust tools and cam pulley bit socket to hold the chain in place
- Suitable for Mercedes- Benz M271



3452 1 / 3

MODEL	ENGINE CODE
C-class 176 (2002-15)	271.820, 271.860, 271.861
C-class Coupe (2011-15)	271.921, 271.940, 271.941
CLC (2008-12)	271.942, 271.943, 271.944
CLK (2002-09)	271.946, 271.948, 271.950
E-class (2002-13)	271.952, 271.954, 271.955
E-class Coupe / Cabriolet (2004-13)	271.956, 271.957, 271.958
SLK (2004-15)	
Sprinter (2007-15)	271.951



CONTENTS :

- A - camshaft locking tool
- B - cam chain tensioner rail wedge tool
- C - cam chain tensioner drift
- D - cam chain retaining bridge
- E - camshaft pulley bit socket (T100)

ENGINE SERIES



KING TONY

BMW

Petrol Engine VANOS Engagement Wrench

9AT1-A02

- For BMW twin camshaft engines with single VANOS unit mounted on inlet camshaft

 298  /  12 / 48



MODEL:

318is, E36 (92-99), 318ti Compact E36 (94-01)
320i, E36 / E46 (92-07), 323i, E36 / E46 (95-01)
325i, E36 / E46 (92-07), 328i, E36 / E46 (95-01)
330i, E46 (00-07), 520i, E39 / E60 (96-05)
523i, E39 (96-00), 525i, E39 / E60 (00-05)
528i, E39 (96-00), 530i, E39 / E60 (00-05)
728i, E38 (94-02), 730i, E65 (02-05)
Z3, (E36) 1.9-3.0 (96-03)
Z4, (E85) 2.2-3.0 (03-06)
X3, (E83) 3.0 (03-06), X5, (E53) 3.0 (99-07)

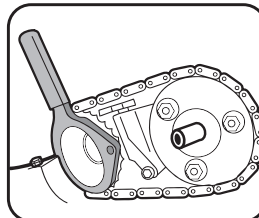

ENGINE CODE:

M50 / M52 Single VANOS (VVT) variants
20 6S 2(Later), 20 6S 3, 25 6S 2(Later)
25 6S 3, 28 6S 1

BMW

Diesel Engine Injection Pump Puller

9AT2-D01

- Specifically designed for holding the sprocket / chain in place when disassembling the VP44 injection pump and high pressure pump
- Common rail fits BMW engines

 528  /  6 / 36



MODEL:

318d / Compact(E46)
320d / td Compact(E46)
330d(E46), 535d(E60 / E61), 730d(E38)
X5 3.0d(E53), 530d(E39 / E60 / E61)
525d(E39 / E60 / E61)

ENGINE CODE:

M47 / M57
1 Series E87, 3 Series E46 / E90
5 Series E39 / E60, 6 Series E63
7 Series E38 / E65, X3 E83 and E53 / E70

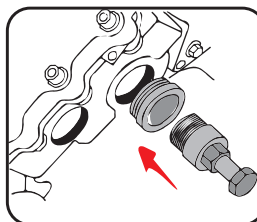

CHEVROLET

Petrol Engine Tension Adjustment Wrench Set (Via Water Pump)

9AT1202

- The set includes 41mm and 46mm tension adjust wrench
- Suitable for Vauxhall / Opel and Chevrolet engines

 695  /  6 / 24



MODEL:

9AT1202-B(41mm)
Kalos (04-08), Aveo (06-08),
Espero / Aranos (95-97), Nexia (95-97)
Lanos (97-03), Nubira / Lacetti (97-09)
Cruze (2009)

ENGINE CODE:

1.4 A13DM A14MS F14S3
1.4 16v, F14D3,
1.5 G15MF
1.5 16v, A15DM A15SMS A15MF
1.6 16v, A16DM A16DMS F16D3 LXT

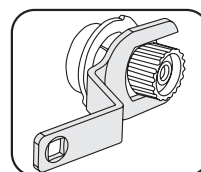

CONTENTS :

- A - tension adjustment wrench (46mm)
- B - tension adjustment wrench (41mm)



BMW

Petrol Engine Timing Alignment Set



9AT1112E

- The set includes camshaft locking tool, VANOS alignment plate, flywheel locking pin
- Suitable for BMW 2.5/3.0 liters chain drive six cylinder, twin cams 16v petrol engines
- Use to lock camshaft in TDC position when setting or adjusting engines timing



12 PC.

5900 1 / 3

MODEL:

128i. E82 (07-08)
 130i. E81/87 (05-08)
 135iS. E82 (07-08)
 323i. E90/91/92/93 (04-08)
 325i/xi. E90/91/92/93 (04-08)
 328i/xi. E90/91/92/93 (04-08)
 330i/xi. E90/91/92/93 (04-08)
 335i/xi. E90/91/92/93 (05-08)
 523i/Li. E60/61 (04-08)
 525i/Li/xi. E60/61 (04-08)
 528i/xi. E60/61 (06-08)
 530i/Li/xi. E60/61 (05-08)
 535i/xi. E60/61 (06-08)
 630i. E63/64 (04-08)
 730i/Li. E65/66 (04-08)
 X3 2.5/3.0 E83 (06-08)
 X5 3.0 E70 (06-08)
 Z4 2.5/3.0 E85/86 (05-08)

ENGINE CODE: N51 / N52 / N52K (Valvetronic)
 N53 / N54 (Direct Injection)

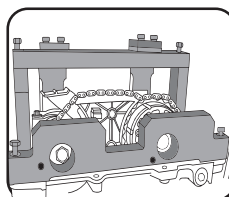
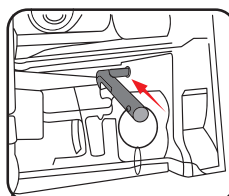

CONTENTS :

- A - VANOS alignment plate (Red for N53/N54, Silver for N51/N52/N52K)
- B - camshaft locking tool
- C - flywheel locking pin

PSA PEUGEOT CITROËN

Petrol Engine Setting & Locking Set – BMW/PSA

9AT1010E

- The set includes camshaft setting tool, crankshaft locking pin & chain tensioner tool
- Suitable for BMW Mini and PSA Peugeot Citroën 1.4/1.6 16v valvetronic direct injection engines
- Use to lock and adjust engine timing



10 PC.

2384 1 / 5

MODEL:

Citroen
 C4(08-11)
 C4 Picasso(08-13)
Peugeot
 207(06-11)
 207CC(07-14)
 308(07-14)
 3008(09-12)
 5008(09-11)

ENGINE CODE:

Citroen
 8FR(EP3)
 5FS(EP6)
Peugeot
 EP3(8FS)
 EP6(5FW)
 EP6DT(5FX)
 8FS(EP3)
 EP6DTS(5FY)

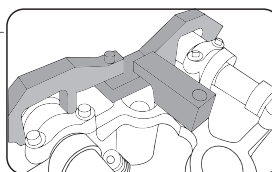

CONTENTS :

- A – camshaft setting tool (inlet)
- B – camshaft setting tool (exhaust)
- C – camshaft setting tool
- D – camshaft setting clamp
- E – crankshaft locking pin
- F – chain tensioner tool
- G – M10 screw*4

ENGINE SERIES



PSA PEUGEOT CITROËN

Petrol Engine Timing Set



9AT1021E

- The set includes special flywheel tools and cam/ crankshaft timing pin
- Use to replace timing belt engines of:
1.0 / 1.1 / 1.4 / 1.6 / 1.6VTS / 1.8 16v / 2.0 / 2.0 16V / 2.2
- Include PSA "EW coded" twin-cam 16v engine and HPI versions
- Suitable for PSA Peugeot / Citroen engines

2164 1 / 10



21 PC.

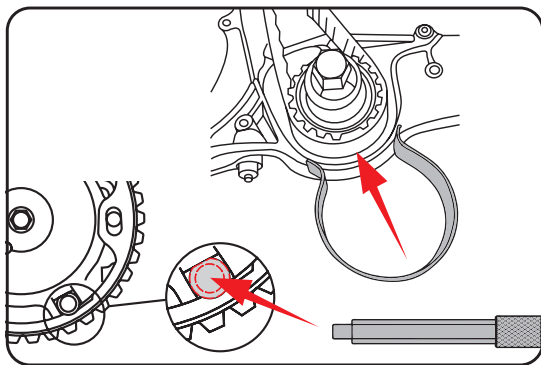

CONTENTS :

- A – timing belt retaining tool
- B – tensioner adjusting tool
- C – flywheel locking tool
- D – flywheel holding tool
- E – flywheel plate locking tool
- F – flywheel locking tool
- G – flywheel locking tool
- H – tensioner locking tool
- I – tensioner locking tool
- J – timing pin

PSA PEUGEOT CITROËN

Diesel Engine Setting Tool (Belt Drive)

9AT2-A01

- The set includes flywheel locking pin, TDC timing pin and tensioner retaining tool
- Use for holding engine timing position when replacing timing belt
- Suitable for Fiat, Iveco, Renault, Citroen / Peugeot, Vauxhall / Opel



CONTENTS :

- A – TDC timing pin
- B – flywheel locking pin (2pc)
- C – tensioner retaining tool

112 12 / 120

MODEL: 2.8D/Tdi/Hdi
Relay / Jumper (01-06)
Boxer (00-06)

ENGINE: 8140.43
8140.43S
8140.63

Petrol & Diesel Engine Flywheel Holding & Locking Tool

9AT3-E02

- Used to remove the crankshaft pulley when replacing the timing belt
- The pulley retaining bolt is fitted with high torque and the flywheel must be securely locked during installation / removal
- Jamming tools into the teeth of the flywheel will cause serious damage to both teeth and housing

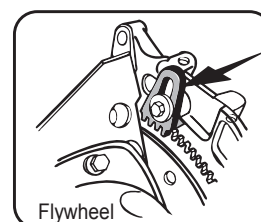

64 25 / 100

MODEL: Petrol 1.0 to 2.0 TU / XU (Belt)
XU 1.6 to 2.0
Diesel 1.50 to 2 .50 TUD / XUD (Belt)
XU1.6 to 2.0
XD1.8D to 1.9D



FIAT

Petrol Engine Setting & Locking Set



9AT1002E

- The set includes camshaft setting tool and tensioner retaining pin
- Suitable for Vauxhall / Opel & Fiat engines
- Use to lock the camshafts on the correct timing position



1510 1 / 10

MODEL: Petrol 2.2 16v. Twin Cams(Chain)
Croma (05-09)

ENGINE CODE: Petrol 2.2 16v. Twin Cams(Chain)
194A1.000

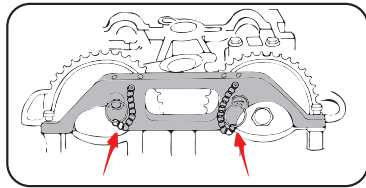

- CONTENTS :
- A - camshaft setting tool
 - B - tensioner retaining pin

FIAT

Diesel Engine Setting & Locking Tool Set



9AT2006E

- The set includes flywheel holding tool, crankshaft locking tool and camshaft setting tools
- Suitable for Lancia, Alfa Romeo and Fiat engines
- Use to set and lock engines timing



1360 1 / 10

Diesel
1.6JTD / 1.9JTD / 2.0JTD / 2.4JTD Multijet(Belt)
Punto (99-06), Grande Punto (05-09)
Idea (04-08), Brava/Bravo (98-02)

MODEL: Linea (07-09), New Bravo (07-09)
Marea/Weekend (99-03), Stilo (01-06)
Croma (05-09), Multipla (99-07)
Doblo/Cargo (02-09), Palio Weekend (02-06)
Sedici (06-09), Strada Pick-Up (03-06)

1.6JTD 16v.
198A2.000, 198A3.000, 198A6.000
350A2.000

1.9JTD 8v.
182B4.000, 182B9.000, 186A6.000
186A8.000, 186A9.000, 188A2.000
188A7.000, 188B2.000, 192A1.000
192A3.000, 192A8.000

1.9JTD 8v.
192A9.000, 192B4.000, 192B5.000
199A5.000, 939A1.000, 939A5.000
939A7.000, 223A7.000

1.9JTD 16v.
192A5.000, 937A5.000, 939A2.000
939A8.000

2.0JTD 16v.
198A5.000

2.4JTD 10v.
185A6.000

2.4JTD 20v.
939A3.000

ENGINE CODE:

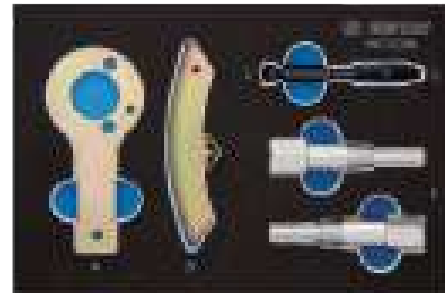

- CONTENTS :
- A&C&D - crankshaft locking tool
 - B - flywheel holding tool (crank pulley removal)
 - E - camshaft setting tool (pair)

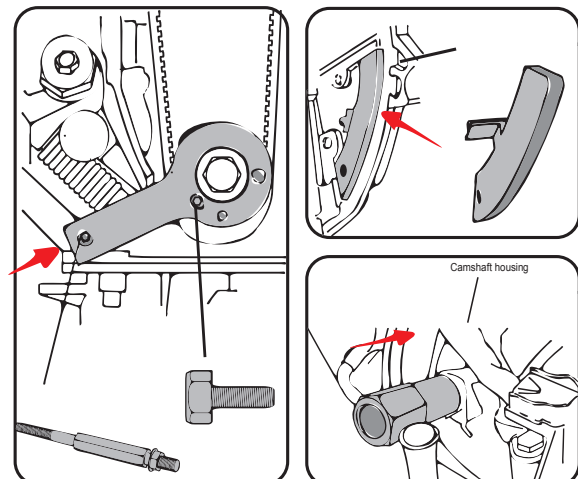

FIAT

Petrol Engine Flywheel Holding Tool

9AT1-E01

- Use to lock the flywheel while removing and replacing the timing belt
- Put it into the teeth of the flywheel to hold the crankshaft up, while releasing or tightening the bolt

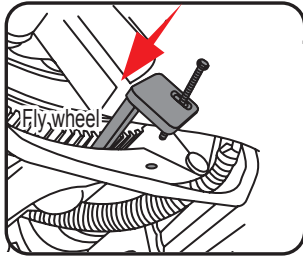

51 20 / 100

MODEL: Stilo (01-08), Brava / Bravo (95-02)
Marea / Weekend (96-03), Multipla (99-09)
Doblo / Cargo (02-06)

ENGINE CODE: 178B3.000, 182A4.000
182A6.000, 182B6.000

Petrol Engine Flywheel Holding & Locking Tool

9AT3-E02

- Used to remove the crankshaft pulley when replacing the timing belt
- The pulley retaining bolt is fitted with high torque and the flywheel must be securely locked during installation / removal
- Jamming tools into the teeth of the flywheel will cause serious damage to both teeth and housing

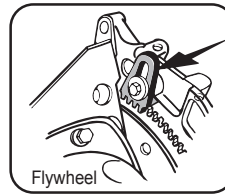

64 25 / 100

MODEL: Petrol 1.6 16v. Twin Cams (Belt)
Stilo

Diesel Engine Setting Tool (Belt Drive)

9AT2-A01

- The set includes flywheel locking pin, TDC timing pin and tensioner retaining tool
- Use for holding engine timing position when replacing timing belt
- Suitable for Fiat, Iveco, Renault, Citroen / Peugeot, Vauxhall / Opel

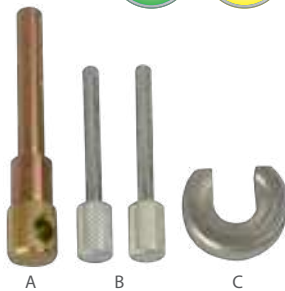

CONTENTS :

- A – TDC timing pin
- B – flywheel locking pin (2pc)
- C – tensioner retaining tool

112 12 / 120

MODEL: 2.5D / 2.5DT / 2.8D / 2.8JTD
Croma (93-97)
Ducato (87-06)
Talento (87-02)

ENGINE CODE: 8140.21, 8140.27, 8140.47R
8140.43, 8140.43S, 8140.63
8144.67

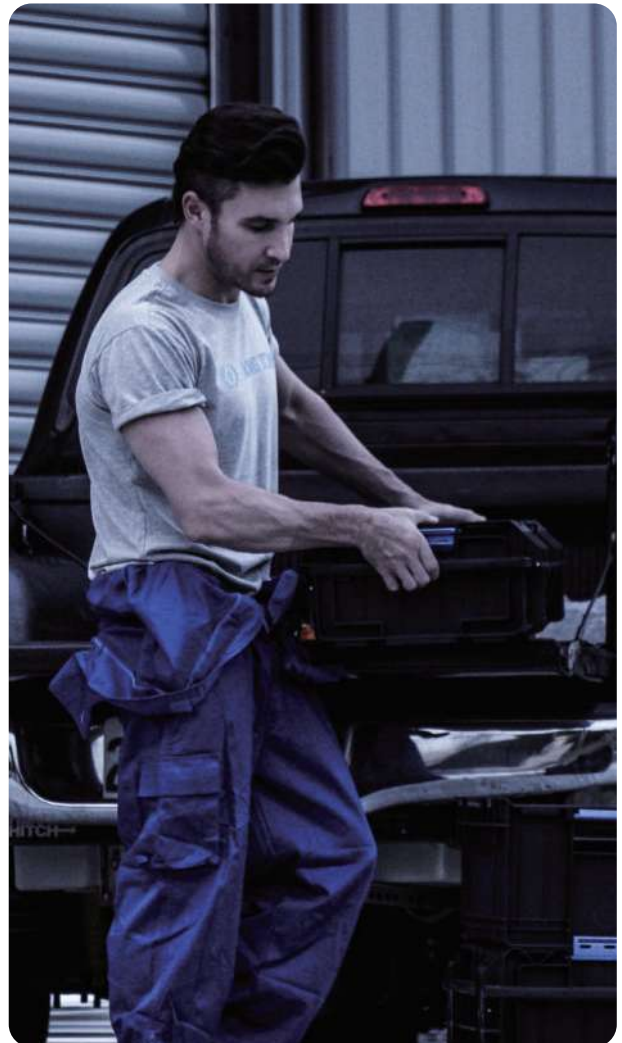

FORD

EcoBoost 1.0 Timing Set



9AT1026E

- Engine Timing Tool Kit suitable for 1.0 petrol EcoBoost and 1.0 SCTi EcoBoost FORD engines.
- Contains tools vital for setting and locking the engine and for setting the position of the variable cam timing units.

16
PC.



4.4 kg / 1 / 4

MODEL: Fiesta (2013-2016), EcoSport (2013-2015), B-Max (2013-2016), C-Max (2012-2016), Transit Courier (2012-2016), Transit Connect (2013-2016), Focus (2012-2016), Grand Tourneo Connect (2013-2015), Grand C-Max (2012-2016), Mondeo (2015-2016), Tourneo Connect (2013-2015)

ENGINE : MICA, M1CB, M1DA, M1DD, M1JA, M1JC, M1JE, M1JH, M2DA, M2DB, M2DC, M2GA, P4JC, P4JD, SFCA, SFCB, SFDB, SFJA, SFJB, SFJC, SFJD, P4JA, P4JB, XMJA, XMJB, M1JA

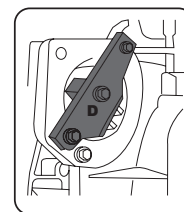
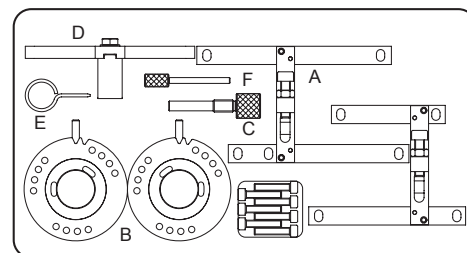

CONTENTS:

- A - Camshaft Locking Tool Set
- B - Camshaft VVT Adjustment Tool Set
- C - Crankshaft Setting Pin
- D - Flywheel Locking Tool
- E - Tensioner Locking Pin
- F - Crankshaft Pulley Positioning Pin

- Remove the starter motor and fit component D in the starter aperture so that its tooth locks the flywheel

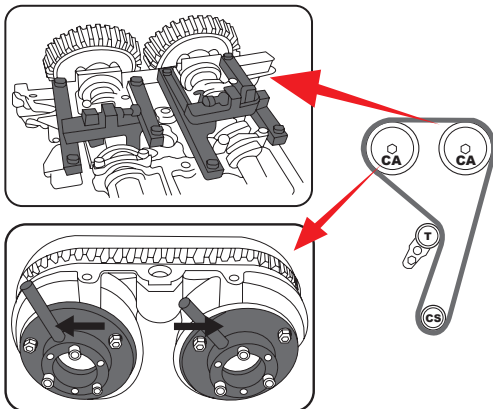

FORD

Petrol Engine Twin Camshaft & Diesel Engine Timing Tool Set



9AT1406E

- The set includes VCT setting plate, camshaft setting plate, crankshaft TDC location pin, tensioner locking pin and flywheel locking tools
- Suitable for 16v. Duratec petrol engine of FORD 1.6 Ti-VCT twin camshaft
- Use to adjust VCT timing on inlet and exhaust camshaft during timing belt replacement



7
PC.

1640 kg / 1 / 10

MODEL: Focus C-Max (03-08)
Focus (04-08)
Mondeo (07-08)

ENGINE CODE: HXDA

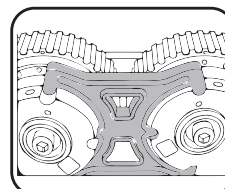
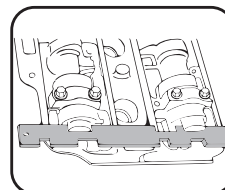

CONTENTS :

- A&E - flywheel locking tool
- B - camshaft setting plate
- C - crankshaft TDC location pin
- D - tensioner locking pin
- F - VCT setting plate
- G - crankshaft pulley alignment tool

Diesel Engine Timing and Injection Pump Setting & Locking Set



9AT2011E

- The set includes sprocket retaining plate, flywheel & tensioner locking pins
- Suitable for chain drive diesel engine of Ford
- Use to install/remove injection pump & set/lock engine timing



1473 1 / 10

MODEL:	Diesel 2.0 / 2.2 / 2.4 TDdi / TDci DURATORQ(CHAIN)
ENGINE CODE:	2.0Ddi ABFA, D3FA, F3FA 2.0 TDdi D5BA, D6BA 2.0 TDci FMBA, FMBB 2.2 TDci QJBA~D 2.4 Ddi D2FA, F4FA 2.4 TDci FXFA, H9FA, JXFA, PHFA

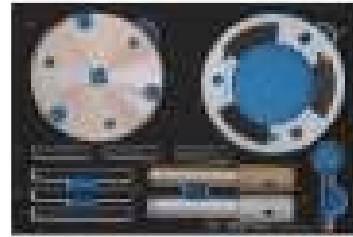

CONTENTS :

- A – access Cover Removal Plate
- B – sprocket Retaining Plate
- C – location Pins (3 PC.)
- D – locking Pins (3 PC.)
- E – flywheel Locking Pins (2 PC.)
- F – tensioner Locking Pin

FORD

Diesel Engine Setting/Locking Tool (Belt Drive)

9AT2-C01

- The set includes crankshaft (oval / round), camshaft and tensioner locking pins
- Suitable for most of general VAG 1.4 / 1.9 / 2.0 TDi PD DOHC engines
- Also for Ford Galaxy models engine

408 10 / 40

MODEL:	Galaxy 1.9
ENGINE CODE:	ASZ / ANU

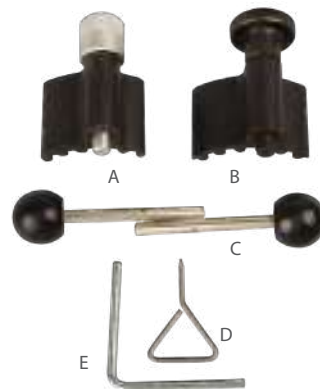
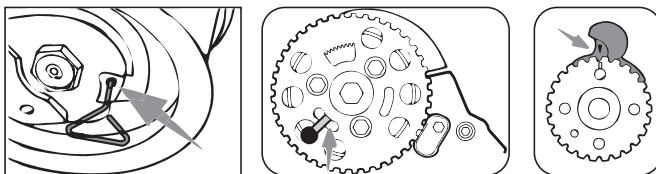

CONTENTS :

- A - Crankshaft Locking Tool (Silver / Oval)
- B - Crankshaft Locking Tool (Black / Round)
- C - Camshaft Locking Pins (2 pcs)
- D - Tensioner Pulley Locking Pin
- E - Auxiliary Belt Tensioner Locking Pin

Petrol Engine Timing Set – Ford 2.0 EcoBoost



9AT1105E

- The set includes cam & crankshaft alignment tool and tensioner locking pin
- Suitable for Ford fitted with SCTi EcoBoost / Ti-VCT 2.0lt direct injection engines
- Camshaft tool use for vehicles manufactured **May 2011** and **after May 2011**

1745 1 / 10

MODEL:	Galaxy(2010-), Mondeo(2010-) S Max(2010-), Focus(2011-)
ENGINE CODE:	Galaxy 2.0 TNWA, TNWB, TPWA Mondeo 2.0 TNBA, TPBA S Max 2.0 TNWA, TNWB, TPWA Focus 2.0 MGDA, XQDA

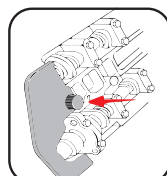
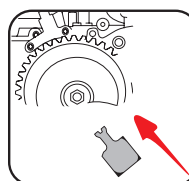

CONTENTS :

- A – camshaft alignment plate
- B – camshaft alignment plate
- C – crankshaft locking tool
- D – crankshaft timing pin
- E – tensioner locking pin



FORD

Petrol & Diesel Engine Flywheel Holding Set

9AT3-E01

- Lock crankshaft in timed position by locating into flywheel
- Suitable for counter-holding crankshaft when releasing or tightening crankshaft pulley bolt



373 36 / 36

MODEL:
1.8 TDI / TDdi / TDCi Petrol Engines (Belt)
 Fiesta / Courier, Tourneo Connect,
 Focus C-Max, Mondeo, S-Max, Galaxy,
 Transit Connect
2.0TDCi Diesel Engines (Belt)
 Focus / C-Max, S-Max, Galaxy
1.6Ti-VCT Petrol Engines (Belt)
 Focus, Mondeo, Focus C-Max

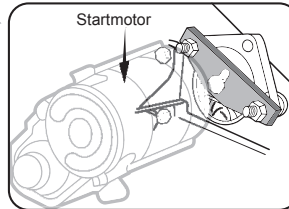

ENGINE CODE:
1.8 TDI / TDdi / TDCi Petrol Engines (Belt)
 RTN, RTQ, RTP, BHDB, BHPA, C9DA, C9DB
 C9DC, F9DA, F9DB, FFBA, FFDA, FFWA
 HPCA, HPCB, P7PA, P9PA, QYBA, QYWA
 R2PA, R3PA, RWPA, KKDA
2.0TDCi Diesel Engines (Belt)
 AZWA, G6DA, G6DB, G6DC, QXWA
1.6Ti-VCT Petrol Engines (Belt)
 HXDA

IVECO

Diesel Engine Setting Tool (Belt Drive)

9AT2-A01

- The set includes flywheel locking pin, TDC timing pin and tensioner retaining tool
- Use for holding engine timing position when replacing timing belt
- Suitable for Fiat, Iveco, Renault, Citroen/Peugeot, Vauxhall/Opel



CONTENTS :

- A – TDC timing pin
- B – flywheel locking pin (2pc)
- C – tensioner retaining tool



112 12 / 120

MODEL:
2.5D/2.8D
 Daily (91-06)
 Turbo Daily (94-00)

ENGINE CODE:
 8140.07, 8140.27S, 8140.47
 8140.47R, 8140.67F, 8140.97
 8140.23, 8140.43C, 8140.43S

LANCIA

Diesel Engine Setting & Locking Set

9AT2006E

- The set includes flywheel holding tool, crankshaft locking tool and camshaft setting tools
- Suitable for Lancia, Alfa Romeo and Fiat engine
- Use to set and lock engines timing



CONTENTS :

- A&C&D - crankshaft locking tool
- B - flywheel holding tool (crank pulley removal)
- E - camshaft setting tool (pair)

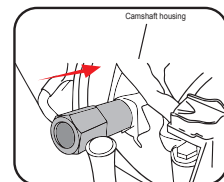
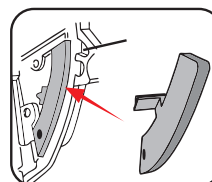

1360 1 / 10

MODEL:
2.0JTD / 2.2JTD (Belt)
 Lybra (99-07)
 Musa (04-09)
 Kappa (98-02)
 Thesis (02-07)

ENGINE CODE:
1.9JTD 8v.
 323.02, 371.01, 188B2.000, 937A2.000
2.4JTD 10v.
 838A8.000, 839A5.000, 839A6.000
2.4JTD 20v.
 841C.000, 841D.000, 841G.000, 841H.000



LANCIA

Petrol Engine Flywheel Holding Tool

9AT1-E01

- Use to lock the flywheel while removing and replacing the timing belt
- Put it into the teeth of the flywheel to hold the crankshaft up, while releasing or tightening the bolt

51 / 20 / 100

MODEL: Delta (96-99)
Lybra (99-06)

ENGINE CODE: 182A4.000
182A6.000

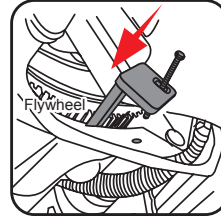

Diesel Engine 2.5TDS Timing Set

9AT2106E

- The set includes camshaft setting plate, tensioner lever, tensioner retaining pin, flywheel locking pin and pump remove & sprocket retainer
- Suitable for BMW, Land Rover and Opel engines
- Use to retain and support the sprocket and timing chains in position when the pump is removed

2480 / 1 / 5

MODEL: 2.5D Turbo (Chain)
Range Rover (94-02)

ENGINE CODE: 256T M51

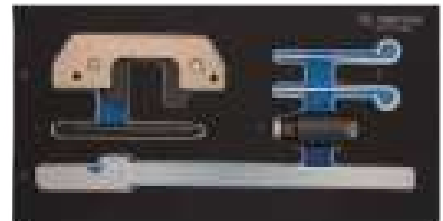
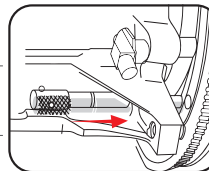
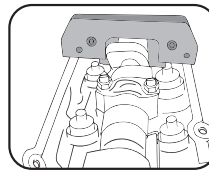

CONTENTS :

- A – camshaft setting plate
- B – tensioner lever
- C – flywheel locking pin
- D – tensioner retaining pin
- E – pump remove & sprocket retainer (2 part)

LAND ROVER

Diesel Injection Pump Puller

9AT2-D01

- Specifically designed for holding the sprocket / chain in place when disassembling the VP44 injection pump and high pressure pump
- Common rail fits BMW engines

528 / 6 / 36

MODEL: Freelander (00-06)
Td4 (2.0d)
Range Rover (02-06)
Td6 (3.0d)

ENGINE CODE: 204D3 / Td4
(2.0 M47:BMW)
306D1 / Td6
(3.0 M57 : BMW)

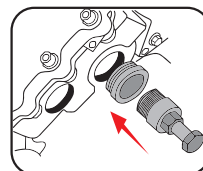

RENAULT

Diesel Engine Setting & Locking Set



9AT2008E

- The set includes auxiliary belt tensioner locking pin, camshaft setting tools, crankshaft pulley holding tool, chain tensioner locking pin and crankshaft locking pin
- Suitable for 2.0 dCi chain drive engines of Renault, Nissan and Vauxhall / Opel

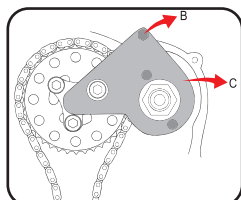
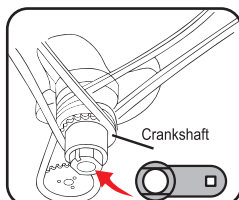

CONTENTS :

- A&H - camshaft gear alignment tool
- B&C - camshaft setting plate
- D - crankshaft locking pin
- E - auxiliary belt tensioner locking pin
- F - crankshaft pulley holding tool
- G - chain tensioner locking pin

2376 1 / 5

MODEL:

Megane II (07-09)
Scenic / Grand Scenic (08-09)
Laguna II (01-05)
Vel Satis (05-09)
Espace / Grand Espace (08-09)
Koleos (08-09)
Trafic (07-09)

ENGINE
CODE:

2.0 dCi M9R
700, 721, 722, 724, 740, 742, 746, 760
761, 780, 802, 803, 805, 830, 832, 833

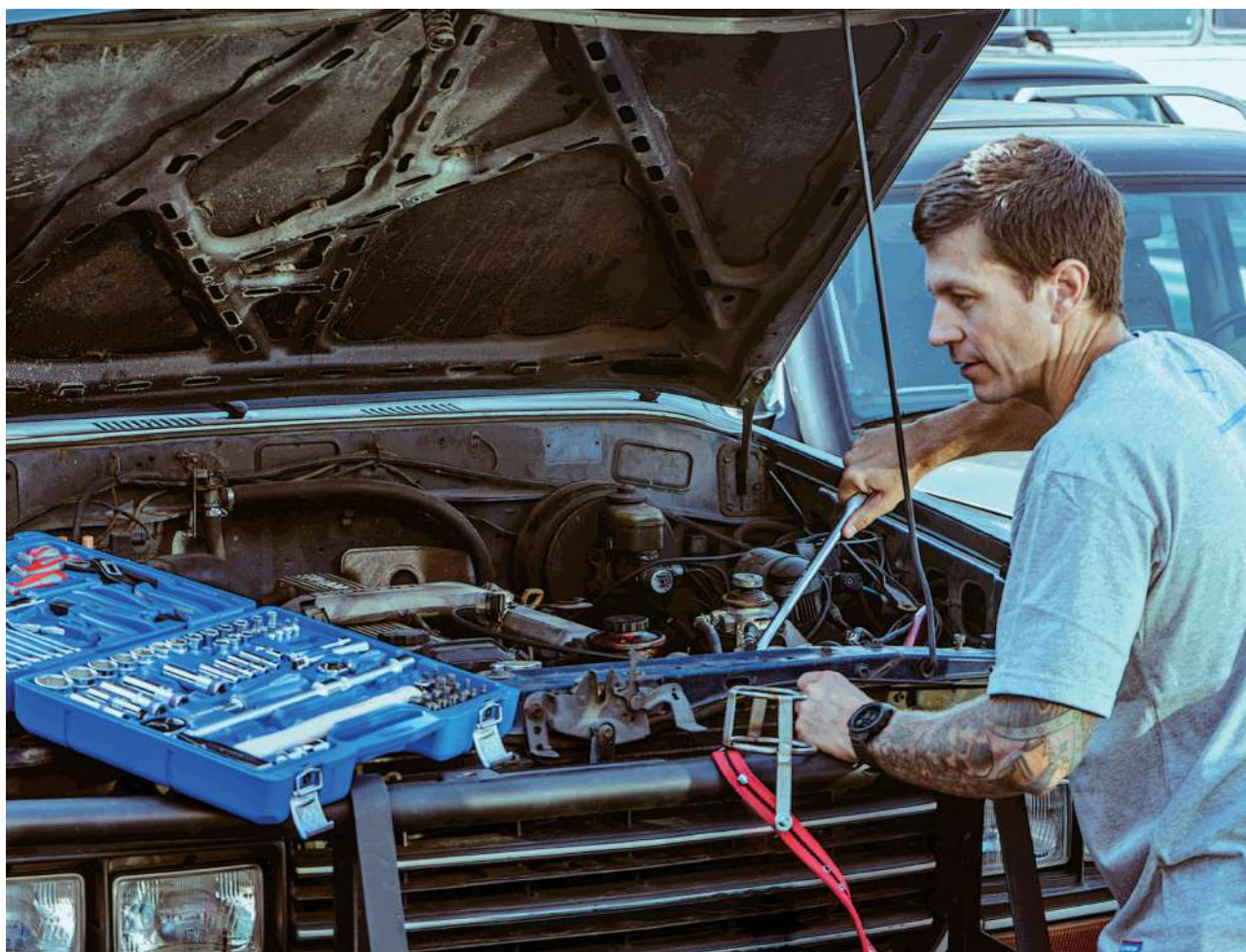

RENAULT

Petrol Engine Timing Locking Set-2.0 16V IDE - F5R

9AT1-A03

- The set includes crankshaft timing pin and camshaft setting plate, to aid timing belt replacement
- Suitable for Renault 2.0 IDE twin cam petrol engines found in Laguna and Megane vehicles

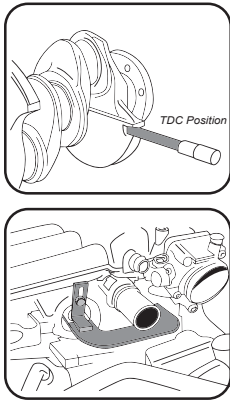

511 10 / 30

MODEL: Megane (99-03)
Laguna II (01-05)

ENGINE CODE: F5R700, 701, 740

Diesel Engine Setting Tool (Belt Drive)

9AT2-A01

- The set includes flywheel locking pin, TDC timing pin and tensioner retaining tool
- Use for holding engine timing position when replacing timing belt
- Suitable for Fiat, Iveco, Renault, Citroen / Peugeot, Vauxhall / Opel



CONTENTS :

- A - TDC timing pin
- B - flywheel locking pin (2pc)
- C - tensioner retaining tool

112 12 / 120

MODEL: 2.5D / 2.5D Turbo / 2.8dTi / 2.8dCi
Trafic (98-00)
Master (98-07)

ENGINE CODE: S8U
720, 722, 730, 731, 742, 748
750, 752, 770, 772, 780, 782
S9U
700, 702, 704, 714, 740
S9W
206, 208, 212, 700, 702

Petrol & Diesel Engine Timing Set(dCi Engines)

9AT3-A03

- The set includes camshaft / crankshaft locking pin and TDC timing pin
- Used for timing belt replacement
- Suitable for Renault 1.5 and 1.9 dCi diesel and petrol engine



CONTENTS :

- A - crankshaft Locking Pin
- B - TDC Timing Pin
- C - camshaft/Crankshaft Locking Pin

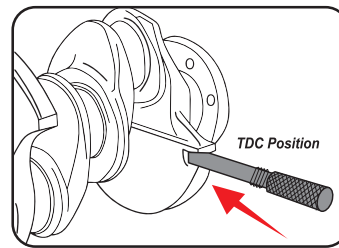

RENAULT (Belt)

220 10 / 100

Diesel

Clio 1.5 dCi (01-08)
Clio 1.9 DTi (99-03)
Espace 1.9 TDi (97-02)
Kangoo 1.5 dCi (04-08)
Kangoo 1.9 DTi (99-03)
Laguna 1.9 DTi (97-03)
Megane II 1.5 dCi (02-05)

MODEL: Megane 1.9 D / TD / TDi (95-03)
Scenic II 1.5 dCi (02-05)
Scenic 1.9 TD (95-99)

Petrol

Clio 1.8 (92-01)
Espace 2.0 (92-01)
Laguna 1.8 (92-01)
Megane, 2.0 (96-99)
R19 1.8 (92-01)
F3R Scenic 2.0 (96-99)

ENGINE CODE: Diesel
K9K
F8Q
F9Q
Petrol
F3P
F3R

RENAULT

Petrol & Diesel Engine Flywheel Holding & Locking Tool

9AT3-E02

- Used to remove the crankshaft pulley when replacing the timing belt
- The pulley retaining bolt is fitted with high torque and the flywheel must be securely locked during installation / removal
- Jamming tools into the teeth of the flywheel will cause serious damage to both teeth and housing
- Suitable for petrol and diesel engine

64 25 / 100

MODEL: Petrol 1.2 to 2.2 (Belt)
F3R, F7R, F7P, F3P, E7J
F8M and F8Q (early)
Diesel 1.50 to 2.50 TUD / XUD (Belt)
F3R, F7R, F7P, F3P, E7J, F8M and F8Q (early)

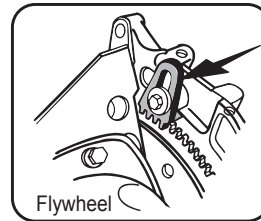

NISSAN

Diesel Engine Setting & Locking Tool Set

9AT2008E

- The set includes auxiliary belt tensioner locking pin, camshaft setting tools, crankshaft pulley holding tool, chain tensioner locking pin and crankshaft locking pin
- Suitable for 2.0 dCi chain drive engines of Renault, Nissan and Vauxhall / Opel

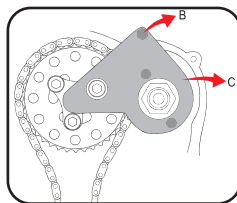
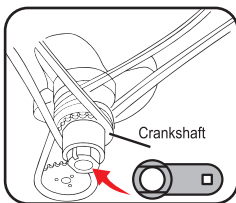

2376 1 / 5

MODEL: Primastar (08-09)
Qashqai (08-09)
X-Trail (07-08)

ENGINE CODE: M9R
780, 830, 832, 833



CONTENTS :

- A&H - camshaft gear alignment tool
- B&C - camshaft setting plate
- D - crankshaft locking pin
- E - auxiliary belt tensioner locking pin
- F - crankshaft pulley holding tool
- G - chain tensioner locking pin



SAAB

Diesel Engine Setting & locking Set



9AT2005E

- The set includes crankshaft locking tool, camshaft setting tools(pair) and a tensioner locking pin
- Suitable for Saab, Vauxhall / Opel engine
- Use to set and lock engines timing

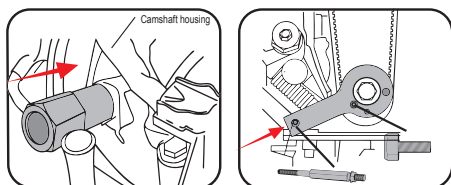

1295 1 / 10

MODEL: Diesel 2.2D T1D
9-3 (98-04), 9-5 (02-06)

ENGINE CODE: Diesel 2.2D T1D
Z19DT / Z19DTH



- CONTENTS :
- A&D - crankshaft locking tools
 - B - camshaft setting tool (pair)
 - C - tensioner locking pin

SUZUKI

Diesel Engine Setting & Locking Set

9AT2004E

- The set includes flywheel locking pin, camshaft setting tools, tensioner locking pin
- Use to retain timing position only. DO NOT use them to hold camshafts in position while releasing or tightening the sprocket bolts

1101 1 / 10

MODEL: Diesel 1.3 DDIS (Belt)
Swift (04-09)
Ignis (03-09)
Wagon R+ (03-08)

ENGINE CODE: Diesel 1.3 DDIS (Belt)
Z13DT

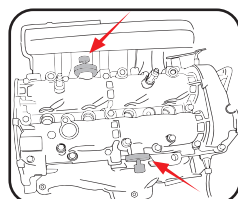
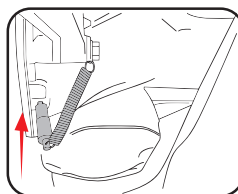

- CONTENTS :
- A- camshaft setting tool set (pair)
 - B- flywheel locking pin
 - C- tensioner retaining pin

VOLKSWAGEN GROUP AUDI/SKODA/VW/SEAT

Petrol Engine Twin Camshaft Setting & Locking Set - VAG 1.4 / 1.6 FSi (Chain)

9AT1103E

- The set includes camshaft setting plate, TDC position tool (with DTI) and tensioner locking pin
- 9AT1103 'B' TDC positioning tool has to use with 9AT3-F01(not included in this set)

1456 1 / 10

MODEL: Audi
A3 (03-07)
Volkswagen
Polo (02-08), Golf V (03-08), Golf Plus (05-08)
Jetta (06-08), Passat (05-08), Touran (03-07)
Skoda
Octavia II (04-08)

ENGINE CODE: 1.4 FSI
AXU, BKG, BLN
1.6 FSI
BAG, BLF, BLP, BTS

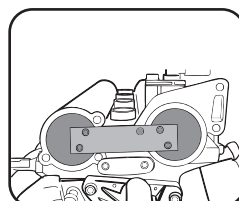
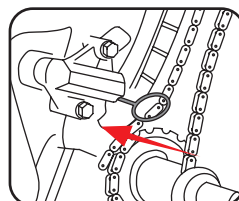

- CONTENTS :
- A - camshaft setting plate
 - B - TDC position tool (with DTI)
 - C - tensioner locking pin



VOLKSWAGEN GROUP AUDI/SKODA/VW/SEAT

Diesel Engine Setting & Locking Set - Pumpe Düse

9AT2012E

- The set includes crankshaft & camshaft locking tool, tensioner setting & adjusting tools
- Suitable for belt drive Pumpe Düse diesel engines of VW group vehicles and Ford (Galaxy)
- Use to set & lock engine to make sure timing is in the correct position during timing belt replacement
- Suggestion :
Check the engine is hydraulic or mechanical tensioner first. (Some of 1.2 1.4 1.9 engines were changed from hydraulic to mechanical.)

1845 1 / 10



12
PC.



CONTENTS :

- A - crankshaft locking tool (silver / oval)
- B - crankshaft locking tool (black / round)
- C - camshaft locking pins (2 pcs)
- D - tensioner adjuster (1.2, 1.4 & 1.9)
- E - tensioner adjuster (later 1.9 & 2.0)
- F - tensioner adjust tool (hexagon)
- G - tensioner locking tool
- H - tensioner locking pin (mechanical)
- I - tensioner locking tool (hydraulic)
- J - tensioner setting tool (hydraulic)
- K - auxiliary belt tensioner locking pin

MODEL:	<p>Audi A2 (01-06), A3 (01-09), A4 (99-09) A5 (08-09), A6 (98-08), TT (08-09) Q5 (08-09)</p> <p>Skoda Fabia (00-07), Fabia II (07-09) Octavia (00-09), Octavia II (04-09) Superb (02-08), Roomster (07-09)</p> <p>Volkswagen Lupo(99-05), Polo(99-07), Fox(05-08) Jetta (05-09), Passat (98-09), Beetle (00-09) Touran (03-09), Sharan (99-09) Caddy (03-09), Golf /Bora(98-08) Golf Plus (05-09), Transporter (03-09)</p> <p>Seat Arosa (99-05), Altea XL(04-09) Leon (00-09), Toledo (04-09) Alhambra (99-09), Ibiza / Cordoba)(02-09)</p> <p>Ford Galaxy (99-06)</p>
--------	--

ENGINE CODE:	<p>1.2TDI PD ANZ, AYZ</p> <p>1.4TDI PD AMF, ATL, BAY, BHC, BMS, BNM, BNV, BWB</p> <p>1.9TDI PD AJM, AMG, ANU, ARL, ASZ, ATD, ATJ, AUJ, AVB, AVF, AVQ, AWX, AXB, AXC, AXR, BEW, BJB, BKC, BKE, BLS, BLT, BMT, BPX, BRB, BRM, BRR,BRS, BRU, BSU, BSW, BTB, BUK, BVK, BXE, BXF</p> <p>2.0TDI PD AZV, BDJ, BDK, BGW, BHW, BKD, BKP, BLB, BMA, BMM, BMN, BMP, BMR, BNA, BPW, BRC, BRE, BRF, BRT, BUZ, BVE, BVF, BVG, BVH, BWV</p> <p>1.9TDI PD (Ford) ANZ, ASZ, AUJ</p>
-----------------	---

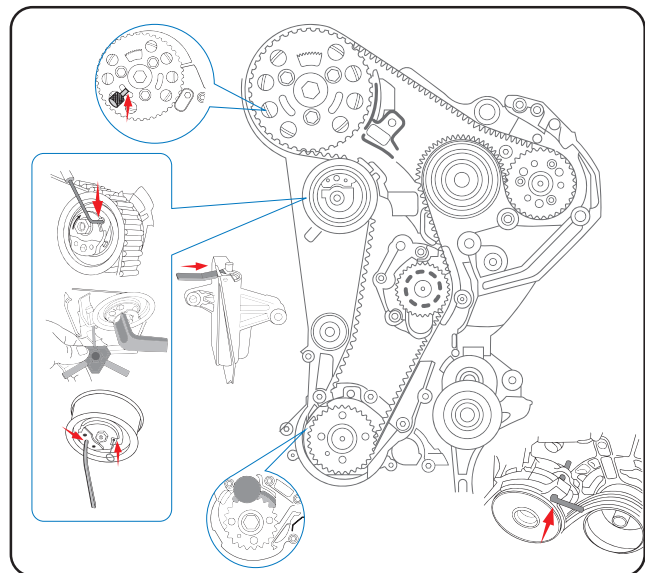

VW/AUDI

VW Audi TIMING TOOL Set VAG 1.6/2.0 TDI CR



9AT2010E

- This set designs to fit the newest common rail diesel engine which is significantly different from the older PD engine.
- The CR engines combines belt and the gear drive by using a toothed belt to transfer the drive from the crankshaft to one of the cam shafts, then using gears to transfer the drive from one cam to the other.



2.7 1/4

MODEL: Audi A3, A4, A5, A6, Q5
Volkswagen Golf, Tiguan, Passat, Eos

1.2 TDI
ANY, AYZ

1.4 TDI
AMF, ATL, BAY, BHC, BNM, BNV

1.9 TDI
AJM, AMG, ANJ, ARL, ARX, ASZ, ATD, ATJ,
AUY, AVB, AVF, AVQ, AWX, AXB, AXC, AXR,
BEW, BJB, BKC, BKE, BLS, BLT, BMT, BPX,
BRB, BRM, BRU, BSU, BSV, BSW, BTB, BVK,
BXE, BXF

ENGINE : 2.0 TDI
AZV, BKD, BDJ, BDK, BGW, BHW, BKP, BLB,
BMA, BMM, BMN, BMP, BMR, BNA, BPW, BRC,
BRE, BRF, BRT, BSS, BUY, BUZ, BVE, BVF, BVG,
BVH, BVW

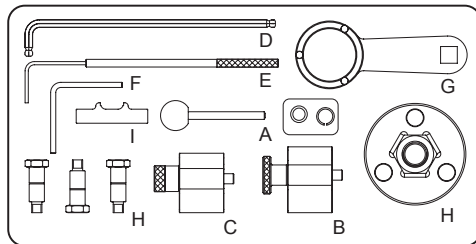

CONTENTS::

- A - Injection pump/ camshaft alignment pin
- B - Crankshaft pulley locking tool(Bored)
- C - Crankshaft pulley locking tool(Non-bored)
- D - Tensioner pulley adjustment tool(2.4mm Hex Key)
- E - Tensioner pulley locking tool
- F - auxiliary tensioner locking tool(3.9mm)
- G - Sprocket holding tool
- H - Cam sprocket hub puller
- I - Oil Pump /Balancer Shaft Alignment Tool

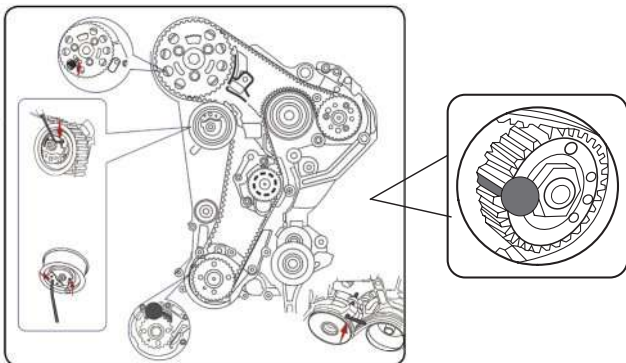

VOLKSWAGEN GROUP AUDI/SKODA/VW/SEAT

Petrol Engine Camshaft Sprocket Holding Tool

9AT1-A01

- For locking the camshaft pulleys when changing the toothed belt
- Engine repairs on 16-valve 1.4/1.6L FSi twin cams injection engine

340 6 / 36

Audi
A2 (00-06)
Seat
Arosa (99-05), Ibiza / Cordoba (99-08)
Leon (99-05), Toledo (99-05), Inca (00-04)

MODEL: Skoda
Fabia (99-07), Octavia (00-08)

Volkswagen
Lupo (98-05), Polo (98-07),
Golf / Bora (97-08), Beetle (01-08)
Caddy (99-08)

ENGINE CODE: AFK, AHW, AJV, AKQ, APE, AQQ, AUA, AUB,
AXP, ARC, ATN, AUS, AVY, AZD, ARR, BBY,
BBZ, BCA, BKY, BAD, BCB

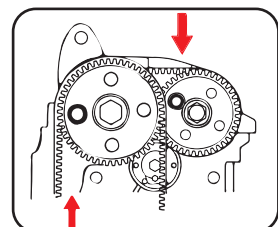
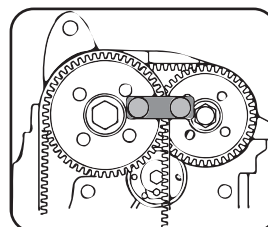

Petrol Engine Chain Tensioner Retainer

9AT1-A04

- Use to hold the chain tensioner in position when removing or installing timing chain
- Suitable for a variety of VAG chain drive engines

 46  12 / 192

MODEL: A3, A4, A6, A8, S3, S4, TT, etc

Audi

AHA, AMB, AMU, APB, ART, ATC, ATQ, AWM,

ENGINE CODE: AWW, AWP, BBD, BCY, BEA, BEL, BFM

VW

AHA, APH, ATQ, AUG, AWM, AWP, AWV, BKF, BNU

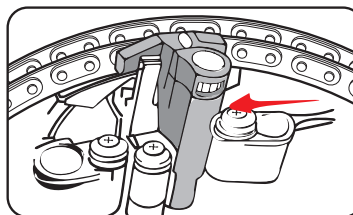

Diesel Engine Setting/Locking Tool (Belt Drive)

9AT2-C01

- The set includes crankshaft (oval/round), camshaft and tensioner locking pins
- Suitable for most of general VAG 1.4/1.9/2.0 TDi PD DOHC engines
- Also for Ford Galaxy models engine

 408  10 / 40

MODEL:

Audi

A2 1.4 (02-06), A3 1.9/2.0 (02-08), A4 1.2 (02-05), A4 1.9/2.0 (02-05), A6 1.9 (20-05)

VW

Beetle 1.9 (02-08), Bora 1.9 (02-08), Fox 1.4 (02-08), Golf 1.9 (02-08), Lupo 1.4 (02-08)

Polo 1.4/1.9 (02-08), Sharan 1.9 (20-08), Jetta 2.0 (03-), Passat 2.0 (03-), Touran 2.0 (03-)

Seat

Altea 1.9 (05-08), Leon 1.9/2.0 (05-08), Toledo 1.9 (05-08)

Skoda

Octavia II 2.0 (03-06), Fabia 1.4 (03-06)

ENGINE CODE:

Audi

AMF, ASZ, ATD, AVB, AVF, AWX, AXR, AZV, BHC, BKC, BKD, BKE, BLB, BMN, BNA, BPW, BRB, BRC, BRD, BRE, BRF, BUY, BVA, BVF, BVG

VW

AJM, AMF, ANU, ARL, ASZ, ATD, AUY, AVB, AVF, AWX, AXR, BAY, BMS, BNM, BNZ, BWB

Seat

BJB, BKC, BLS, BMM, BXE

Skoda

AMF, AZV, BKD

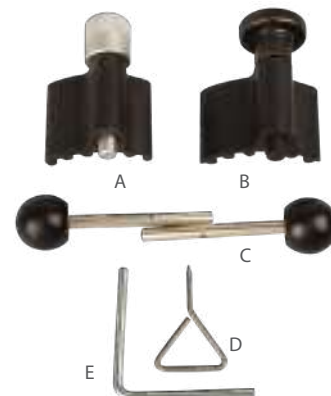
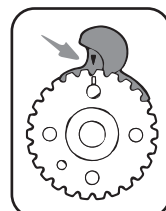
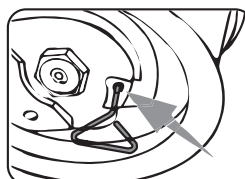
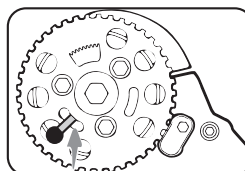

CONTENTS :

- A - crankshaft locking tool (silver / oval)
- B - crankshaft locking tool (black / round)
- C - camshaft locking pins (2 pcs)
- D - tensioner pulley locking pin
- E - auxiliary belt tensioner locking Pin

VAUXHALL/OPEL

Petrol Engine Setting & Locking Set

9AT1002E

- The set includes camshaft setting tool and tensioner retaining pin
- Suitable for Vauxhall / Opel & Fiat engine
- Use to lock the camshafts on the correct timing position

 1510  1 / 10

MODEL:

Petrol 2.2 16v. Twin Cams(Chain)

Astra-G (00-06)

Astra-H (06-09)

Speedster / VX220 (00-06)

Vectra-B+C (00-08)

Signum (03-08)

Zafira-A+B (00-09)

ENGINE CODE:

Z22SE, Z22YH

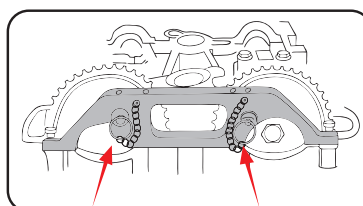

CONTENTS :

- A - camshaft setting tool
- B - tensioner retaining pin



VAUXHALL/OPEL

Petrol Turbo Engine Timing Set



9AT1007E

- The setting & locking set covers a wide range of Vauxhall/Opel and Chevrolet petrol engine.
- Include the necessary tool for setting and locking the camshaft and crankshaft for locking the timing chain tensioner.

7
PC.



2.4 1 / 4

MODEL:

Cadillac : ELR (2014).
Chevrolet :
 Aveo (2011-2015), Cruze (2011-2015),
 Volt (2012-2014), Trax (2013-2015),
 Orlando (2011-2015).
Holden: Volt (2012-2014).
Vauxhall / Opel:
 Agila (2000-2003), Agila-B (2008-2010),
 Adam (2012-2015), Ampera (2011-2015),
 Corsa-C (2000-2014), Corsa-D (2006-2014),
 Insignia (2011-2015), Meriva-B (2010-2015),
 Mokka (2012-2015), Zafira-C Tourer (2012-
 2015),
 Cascada (2013-2015), Astra-J (2009-2015).

1.0 / 1.0 Ecoflex

A10XEP

1.2 / 1.2 Ecoflex

A12XEL, A12XER, LWD/A12XEL, L2Q/A12XEL,
 LWD/B12XEL

1.4 / 1.4 Ecoflex

A14XER, LUJ/A14NET, LDD/A14XEL, LDD/
 A14XER,

ENGINE : LDD/A14XEL, A14XEL, L2Z/A14XEL, LDD/
 B14XEJ,
 LDD/B14XEL, LDD/B14XER, LUJ/B14NEH,
 LUJ/B14NEL, LUJ/B14NET, LDD, LUU,
 LUH/A14NEL

1.4 Turbo

LUJ/A14NEL, LUJ/A14NET, LUJ/B14NET

1.6

LDE/A16XER, LDE/B16XER

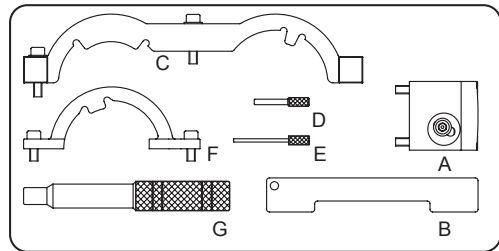

CONTENTS:

- A - Inlet Camshaft Adjusting Tool
- B - Camshaft Locking Plate
- C - Camshaft Sensor Locating Tool
- D - Chain Tensioner Locking Pin 4.0mm
- E - Chain Tensioner Locking Pin 2.5mm
- F - Camshaft Sensor Locating Tool
- G - Crankshaft Locking Pin

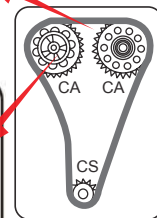
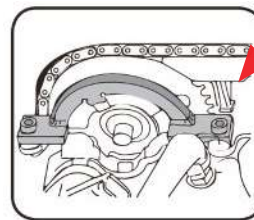
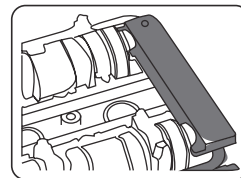

VAUXHALL/OPEL

Petrol & Diesel Engine Tensioner Adjustment Wrench (Via Water Pump)

9AT1202

- The set includes 41mm and 46mm tension adjust wrench
- Suitable for Vauxhall / Opel and Chevrolet engine



2
PC.

695 6 / 24

MODEL:

9AT1202 - A(46MM)

Petrol / 1.8 and 2.0 S.O.H.C

Astra F, Calibra, Frontera C18NZ, C20NE

Diesel / 1.6D and 1.7D

Astra, Cavalier, Vectra 16DA, 17D

9AT1202 - B(41MM)

Petrol / 1.2 / 1.4 / 1.6 S.O.H.C

Corsa B / C , Combo, Astra-F, Vectra-B

C12NE, X12SZ, C14NZ, X14NZ, C14SE

X14SZ, X16SZ, X16SZR, Z16SE

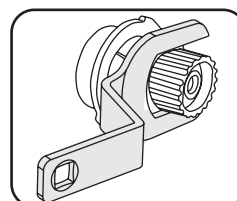

CONTENTS :

- A - tension adjustment wrench (46mm)
- B - tension adjustment wrench (41mm)



VAUXHALL/OPEL

Diesel Engine Setting & Locking Set

9AT2004E

- The set includes flywheel locking pin, camshaft setting tools, tensioner locking pin
- Use to retain timing position only. DO NOT use them to hold camshafts in position while releasing or tightening the sprocket bolt



1101 1 / 10

MODEL: Diesel 1.3D CDTi (Chain)
 Agila (03-08), Agila-B (08-09)
 Corsa / Combo-C (03-09), Corsa-D (08-09)
 Tigra-B(04-09), Meriva (04-09)
 Astra-H (05-09)

ENGINE CODE: Diesel 1.3D CDTi (Chain)
 Z13DT, Z13DTH, Z13DTJ



CONTENTS :

- A - camshaft setting tool set (pair)
- B - flywheel locking pin
- C - tensioner retaining pin

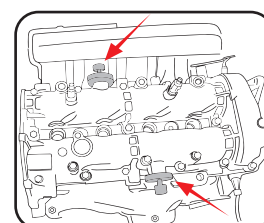
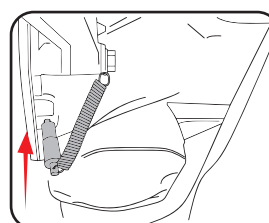

VAUXHALL/OPEL

Diesel Engine Setting & Locking Set

9AT2005E

- The set includes crankshaft locking tool, camshaft setting tools(pair) and a tensioner locking pin
- Suitable for Saab, Vauxhall / Opel engine
- Use to set and lock engines timing



1295 1 / 10

MODEL: Diesel 1.9D CDTi / 2.0D CDTi(Belt)
 Astra-H (04-09), Vectra-C(04-08)
 Signum (04-08), Zafira-B (05-09)
 Insignia (08-09)

ENGINE CODE: Diesel 1.9D CDTi / 2.0D CDTi(Belt)
 1.9CDTi
 Z19DT, Z19DTH, Z19DTJ, Z19DTL
 2.0CDTi
 A20DT, LBS, A20DT, LBX, A20DT, LBV
 A20DT, LCD

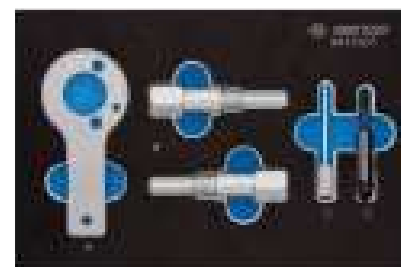
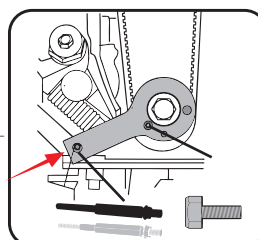
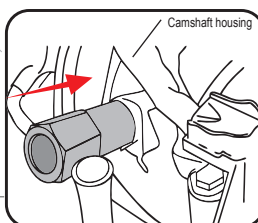

CONTENTS :

- A&D - crankshaft locking tools
- B - camshaft setting tool (pair)
- C - tensioner locking pin



VAUXHALL/OPEL

Diesel Engine Setting & Locking Set



9AT2008E

- The set includes auxiliary belt tensioner locking pin, camshaft setting tools, crankshaft pulley holding tool, chain tensioner locking pin and crankshaft locking pin
- Suitable for 2.0 dCi chain drive engines of Renault, Nissan and Vauxhall / Opel



2376 1 / 5

MODEL:	Vivaro (07-08)
ENGINE CODE:	M9R 780/782/784

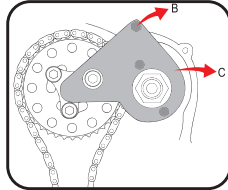
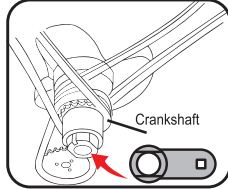

- CONTENTS :**
- A&H – camshaft gear alignment tool
 - B&C – camshaft setting plate
 - D – crankshaft locking pin
 - E – auxiliary belt tensioner locking pin
 - F – crankshaft pulley holding tool
 - G - chain tensioner locking pin

VAUXHALL/OPEL

Diesel Engine 2.5TDS Timing Set



9AT2106E

- The set includes camshaft setting plate, tensioner lever, tensioner retaining pin, flywheel locking pin and pump remove & sprocket retainer
- Suitable for BMW, Land Rover and Opel engines
- Use to retain and support the sprocket and timing chain in position when the pump is removed



2480 1 / 5

MODEL:	Omega-B (94-01)
ENGINE CODE:	2.5D Turbo (Chain) X25DT

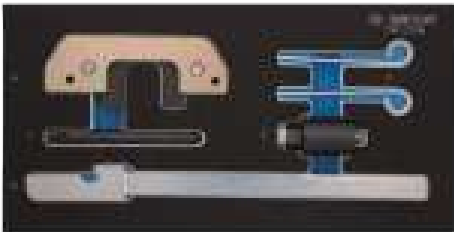
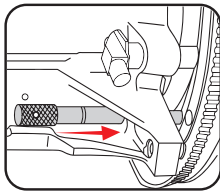
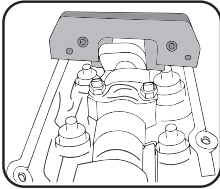

- CONTENTS :**
- A – camshaft setting plate
 - B – tensioner lever
 - C – flywheel locking pin
 - D – tensioner retaining pin
 - E – pump remove & sprocket retainer (2 part)

Diesel Engine Setting Tool (Belt Drive)

9AT2-A01

- The set includes flywheel locking pin, TDC timing pin and tensioner retaining tool
- Use for holding engine timing position when replacing timing belt
- Suitable for Fiat, Iveco, Renault, Citroen / Peugeot, Vauxhall / Opel



112 12 / 120

MODEL:	2.5D / 2.8D Arena (97-01) Movano (98-03)
ENGINE CODE:	S8U 770, 772 S9W 700, 702

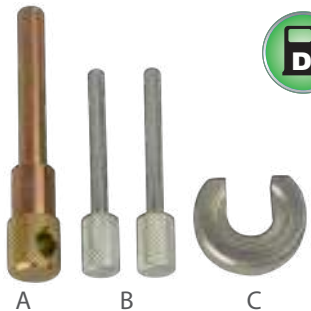

- CONTENTS :**
- A – TDC timing pin
 - B – flywheel locking pin (2pc)
 - C – tensioner retaining tool

Diesel Injection Pump Puller

9AT2-D01

- Specifically designed for holding the sprocket / chain in place when disassembling the VP44 injection pump and high pressure pump
- Common rail fits BMW engines



528 6 / 36

MODEL: Omega - B (01-03)

ENGINE CODE: Y25DT

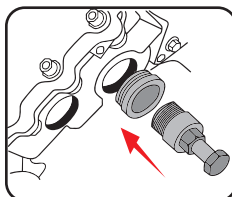

VAUXHALL/OPEL

Petrol Engine Flywheel Holding & Locking Tool

9AT2-E01

- Use to remove the crankshaft pulley while replacing the timing belt
- Put into the teeth firstly, fix steadily on the housing according to manufacturer's guidelines



39 20 / 100

MODEL: Astra (86-91)
Astra-F + G (91-98)
Ascona-C / Cavalier (86-88)
Vectra A (89-95)

ENGINE CODE: 16DA, 17D, 17DR, 17DTL

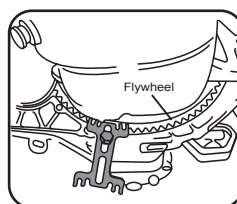

UNIVERSAL

Camshaft & Injection Pump Sprocket Holding Tool

9AT3-A01

- Use to counter hold camshaft or injection pump sprocket to release the retaining bolt
- For universal diesel and petrol engine

912 6 / 24

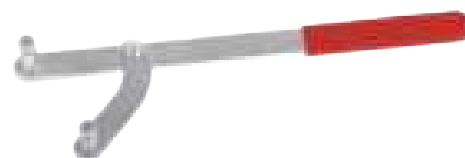
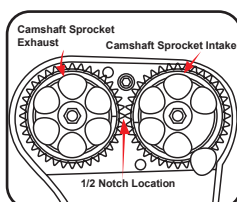
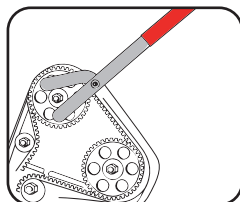

UNIVERSAL

Universal Camshaft Pulley Holding Wrench

9AT3-A02

- Use to hold camshaft pulley while loosening and tightening cam sprockets center bolt
- Designed with 4 pair groove pins 7, 10, 14, 16mm
- Adjustable swivel jaw both side application for most engine
- Capacity : 40 ~ 140mm (1-1/2" ~ 8-5/8")
- For universal engine, especially O.H.C. overhead cam engines cars

1000 1 / 6



9 PC.



UNIVERSAL

Camshaft Sprocket Puller

9AT3-A04

- Use to hold and remove the camshaft sprocket without damaging the sprocket
- Use with 3/8" square drive tool or 19mm wrench
- Suitable for most sprockets from Ø60 to Ø100 mm

KT NO.	Capacity mm	1000	1 / 12
9AT3-A04	60~100	1437	1 / 12



UNIVERSAL

Belt Tensioner Lock Pin Set

9AT3-B01

- Designed for retaining tensioner plunger in fixed position while replacing timing belt
- Suitable for common vehicle and engine

17 20 / 100

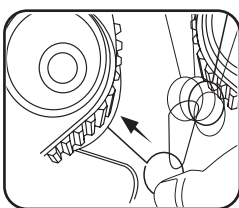

- CONTENTS :
- 0.79mm / .0310"
 - 1.21mm / .0476"
 - 1.41mm / .0560"
 - 1.51mm / .0594"
 - 1.71mm / .0670"
 - 1.92mm / .0760"

UNIVERSAL

Dial Test Indicator

9AT3-F01

- Use to measure and accurately find the piston TDC position
- This tool has to use with TDC Indicator 9AT3-F02
- It can be used for mechanical circularity, flatness.....etc

63 1 / 100

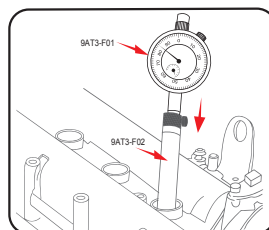

UNIVERSAL

TDC Indicator

9AT3-F02

- Use to measure if the cylinder piston is at TDC position
- This tool has to use with Dial Test Indicator 9AT3-F01

292 1 / 30



VOLKSWAGEN GROUP AUDI/SKODA/VW/SEAT

Petrol Engine Timing Set



9AT1306E

- The set includes camshaft setting plate, camshaft sprocket adjusting tool, tensioner adjusting tool, tensioner locking pin and crankshaft locking pin
- Suitable for Audi VAG 3.0 V6 petrol engine
- Use to replace timing belt and carry out timing tensioner applications



3668 1 / 5

MODEL: Audi
A4 (01-08), A6 (01-08), A8 (03-08)
Cabrio (03-08)

ENGINE CODE: ASN, AVK, BBJ



CONTENTS :

- A - camshaft setting plate (pair)
- B - crankshaft locking pin
- C - camshaft sprocket adjusting tool
- D - tensioner adjusting tool
- E - tensioner locking pin

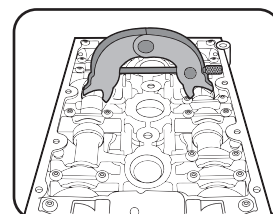
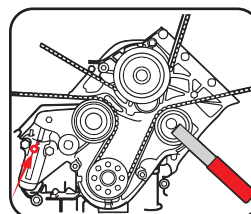

VOLKSWAGEN GROUP AUDI/SKODA/VW/SEAT

Petrol Engine Setting & Locking Set



9AT1506E

- The set includes dial & TDC indicator and camshaft setting tool
- Suitable for 1.2T / 1.4T FSi and 1.4 / 1.6 FSi engines
- Use to check and adjust engine timing

1856 1 / 10

MODEL: Audi
A1(10-12), A3(03-12)
Seat
Altea/Altea XL(08-12), Ibiza/Cordoba(08-12)
Leon(07-12), Toledo(07-09)
Skoda
Fabia II(07-12), Octavia II(04-12)
Roomster(06-12), Superb II(09-12)
Yeti(09-12)
VW
Caddy/ Caddy Maxi(10-12), Eos(06-12)
Golf(03-12), Golf Plus(03-12), Jetta(06-12)
Passat(05-11), Polo(02-12), Scirocco(08-12)
Tiguan(07-12), Touran(03-12)







ENGINE CODE: 1.2T FSI
CBZA, CBZB, CBZC
1.4T FSI
BLG, BMY, BWK, CAVA, CAVB, CAVC, CAVD
CAVE, CAVF, CAXA, CAXC, CDGA, CSMA
1.4 FSI
AXU, BKG, BLN
1.6 FSI
BAG, BLF, BLP, BTS

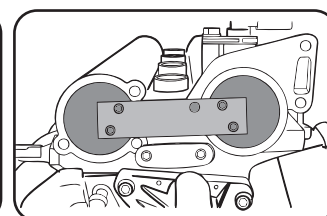
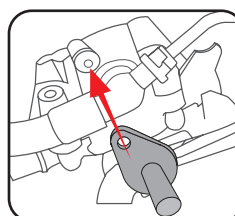

CONTENTS :

- A - camshaft setting plate
- B - TDC indicator
- C - camshaft setting tool
- D - crankshaft locking pin
- E - dial test indicator
- F - tensioner locking pin

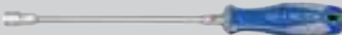

Hose Clamp	KT Item	Suitable Car Brand
 <p data-bbox="293 1144 430 1173">Hose Clamp</p>	 <p data-bbox="679 405 740 427">9AA11</p> <p data-bbox="679 539 740 562">9AA13</p> <p data-bbox="679 667 740 689">9AA16</p> <p data-bbox="679 801 740 824">9AA21</p> <p data-bbox="679 958 740 981">9AA31</p> <p data-bbox="679 1160 740 1182">9AA32</p>	<p data-bbox="999 701 1390 775">Universal VW(Intake), VW, Audi, Opel, Honda, Ford</p>
 <p data-bbox="300 1368 437 1397">Hose Clamp</p>	 <p data-bbox="679 1339 740 1361">9AA17</p>	<p data-bbox="999 1290 1390 1319">VW, Audi, Seat, Skoda, Lamborghini</p>
 <p data-bbox="213 1576 347 1606">CLIC Clamp</p> <p data-bbox="389 1576 539 1606">CLIC-E Clamp</p> <p data-bbox="197 1800 347 1830">CLIC-R Clamp</p> <p data-bbox="389 1800 539 1830">CLIC-GR Clamp</p>	 <p data-bbox="679 1608 740 1630">9AA15</p> <p data-bbox="679 1809 740 1832">9AA25</p>	<p data-bbox="999 1592 1390 1666">VW, Audi, Citroen/Peugeot, Fiat, Mercedes-Benz, Opel, Renault, Ford, Volvo</p>
 <p data-bbox="188 2024 331 2054">Screw Clamp</p> <p data-bbox="357 2024 501 2054">Worm Drive Clamp</p>	 <p data-bbox="711 1964 943 2009">1453-05 / 1453-06 / 1453-07 1453-08 / 1453-10</p>	<p data-bbox="1145 1951 1241 1980">Universal</p>

Straight Hose Clamp Pliers

9AA11

- Use to remove and install spring clamp
- Swivel V-shaped jaws
- Suitable for universal cars, especially VW, Audi, Opel, Honda, Ford

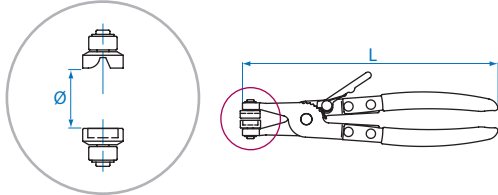

KT NO.	ø mm	inch	L mm		
9AA11	55	8-21/32	220	220	12 / 72

Flat Band Hose Clamp Pliers

9AA16

- Use to remove and install spring clamp
- Swivel concave jaws
- Suitable for universal cars, especially VW, Audi, Opel, Honda, Ford

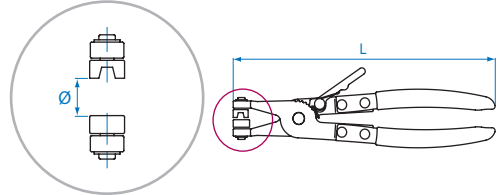

KT NO.	ø mm	inch	L mm		
9AA16	60	8-21/32	220	213	12 / 72

Wire Hose Clamp Pliers

9AA13

- Use to remove and install wire clamp
- Swivel jaws
- Suitable for universal cars, especially Corbin heater hose

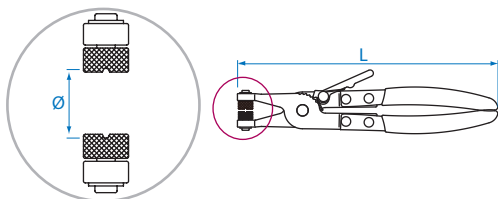

KT NO.	ø mm	inch	L mm		
9AA13	51	8-21/32	220	238	12 / 72

Curved Hose Clamp Pliers

9AA21

- Use to remove and install spring clamp
- 45° swivel concave jaw with greater access in confined spaces
- Suitable for universal cars, especially VW, Audi, Opel, Honda, Ford

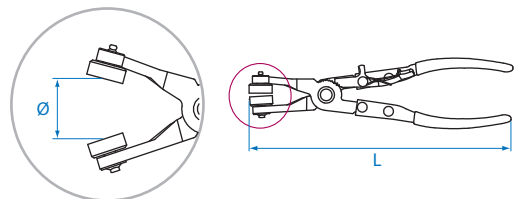

KT NO.	ø mm	inch	L mm		
9AA21	53	8-21/32	220	224	12 / 48



Flexible Hose Clamp Pliers

9AA31

- Use to remove and install spring clamp
- Flexible flat jaw with greater access in confined spaces
- Suitable for universal cars

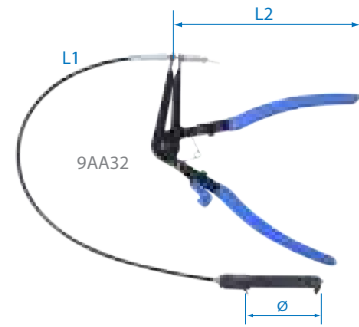

KT NO.	Ø mm	inch	L1 mm	inch	L2 mm	g	kg	box
9AA31	53	25	630	9	225	528	12 / 36	
9AA32	77	27-1/4	700	12	310	756	6 / 24	

CLIC Hose Clamp Pliers

9AA15

- Use to remove and install CLIC and CLIC-R clamp
- Special-designed jaws
- Suitable for VW, Audi, Opel, Citroen, Peugeot, Fiat, Renault, Mercedes-Benz

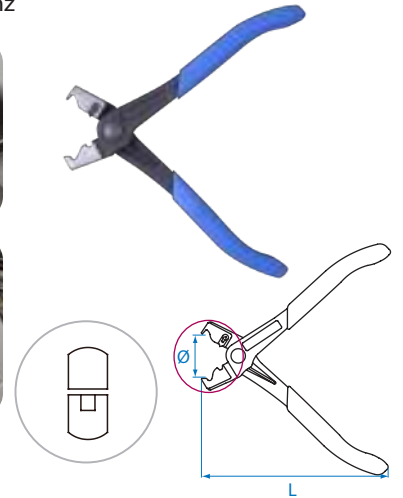

KT NO.	Ø mm	inch	L mm	g	kg	box
9AA15	36	5-19/32	142	223	12 / 72	

Fuel Line Hose Clamp Pliers

9AA17

- Use to remove and install fuel line clamp
- Special pick jaws
- Suitable for VW, Audi, SEAT, Skoda

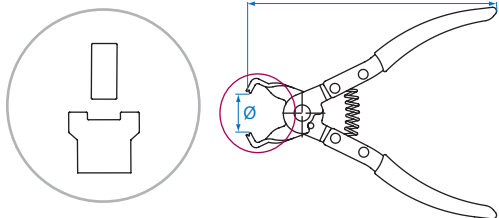

KT NO.	Ø mm	inch	L mm	g	kg	box
9AA17	27	6-3/4	171	188	12 / 60	

360° CLIC Hose Clamp Pliers

9AA25

- Use to remove and install CLIC and CLIC-R clamp
- 360° swivel angle
- Suitable for VW, Audi, Opel, Citroen, Peugeot, Fiat, Renault, Mercedes-Benz

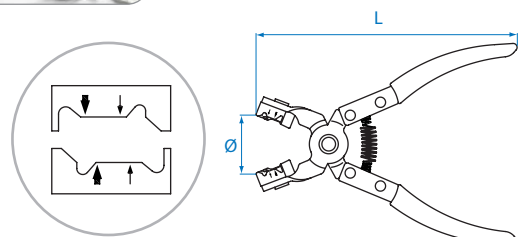
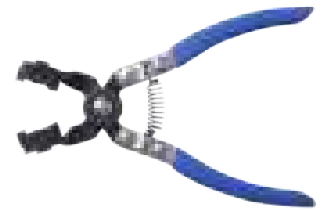

KT NO.	Ø mm	inch	L mm	g	kg	box
9AA25	32	7	175	224	12 / 72	



Fuel Line Pliers

9AB11

- Improved type can also use for fuel lines with plastic snap-together connectors
- Use for VW, Audi, Fiat, GM, Opel/Vauxhall, Mercedes-Benz



KT NO.	Inch	L	mm		
9AB11	9		228	312	12 / 72

9AB12

- For removal and replacement of the connections on the in-line fuel filter
- Use for VW, PSA, Fiat, Opel

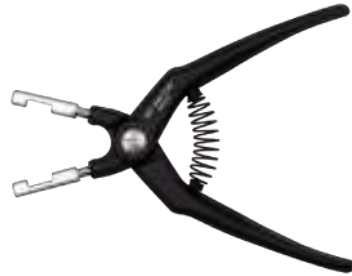

KT NO.	Inch	L	mm		
9AB12	6		150	87	12 / 144



Piston Ring Compressor

9AC

- The square adjustment key wrench forces the rings into the grooves and the clutch prevents it from expanding



KT NO.	H		Ø Capacity		g	Box / Carton
	Inch	mm	Inch	mm		
9AC125-32	3-1/4	80	2-1/4~5	57~125	260	20 / 60
9AC125-40	4	100	2-1/4~5	57~125	280	20 / 60
9AC175-32	3-1/4	80	3-1/2~7	90~175	300	20 / 60
9AC175-40	4	100	3-1/2~7	90~175	320	20 / 60
9AC175-66	6-3/4	165	3-1/2~7	90~175	530	20 / 40

Engine Cylinder Hone 50~175mm

9AC231-54

- For engine cylinders bores from 50mm to 175mm
- Adjustable spring tension and spread limiter easy to remove carbon
- The hone stones is 220 grit, coarse grade

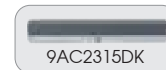

KT NO.	Ø Capacity mm	g	Box / Carton
9AC231-54	50~175	700	6 / 24

Valve Stem Seal Pliers

9AD11

- For removing valve stem seals in multi-valves engine
- Jaw longitudinal toothed - avoids slipping down
- For deeply leveled valve stem seals

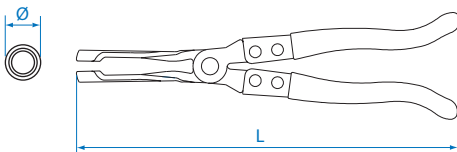

KT NO.	L Inch	L mm	Ø mm	g	Box / Carton
9AD11	11	275	9.5	400	12 / 48

Swivel Oil Filter Wrench

9AE31

- Professional swivel PVC dipped handle
- Easy to bend in different positions for reaching into narrow spaces



KT NO.	Ø Capacity mm	g	Box / Carton
9AE31-73	60~73	275	6 / 36
9AE31-85	73~85	283	6 / 36
9AE31-95	85~95	300	6 / 36
9AE31-111	95~111	307	6 / 36
9AE31-121	110~121	309	6 / 36
9AE31-134	120~134	322	6 / 36





Band Type Oil Filter Wrench

9AE32

- Adjustable metal band
- Suitable for filters between $\varnothing 65\text{mm}$ to $\varnothing 155\text{mm}$



KT NO.	\varnothing Capacity mm		
9AE32-110	65~110	246	25 / 50
9AE32-155	110~155	252	25 / 50

Quick Grip Oil Filter Wrench Set



9AE33

- Quick-adjustable tightening design
- Band type allows for narrow space
- Non-slip reaction teeth provides better grip



- The design offers a stronger clamping force



KT NO.	\varnothing Capacity mm		
9AE33-110	65~110	305	1 / 25
9AE33-155	110~155	311	1 / 25



Strap Wrench

3203

- Strap wrench for oil filter



KT NO.	Capacity mm	Overall length Inch	mm		
3203	Ø 60~140	8-3/4	223	242	50
320300	strap			46	80
3203A0	Ø 60~260	8-3/4	223	300	45
320301	strap			73	80

32067A

- Aluminum alloy handle and strong polyester strap for tight grip
- Suitable for oil filter or any polished pipe



KT NO.	Overall Length Inch	mm	Capacity mm		
32067A	12	295	Ø 60~180	344	25 / 50
3206A00	Polyester strap			35	25 / 50

320760

- Strap wrench for oil filter
- Use with 1/2" square drive tool



KT NO.	Overall length Inch	mm	Capacity mm		
320760	11	280	Ø 60~160	256	12 / 72

Chain Wrench

3204

- Chain wrench for oil filter



KT NO.	Capacity mm	Overall length Inch	mm		
3204	Ø 60~140	8-3/4	225	359	50

Chain Wrench

3205

- Heavy duty oil filter chain wrench, specially for auto, truck and agricultural equipment
- Flexible in confined space
- Suitable for all types of oil filters



- Adjust to appropriate size of the oil filter.



- Release the chain to reinstate it.

KT NO.	Capacity mm	Chain length mm		
320540	Ø 60~105	350	742	6 / 24
320560	Ø 60~160	520	880	6 / 24



Cup Type Oil Filter Wrench

9AE1

3/8"

- 3/8" square drive
- Withstands up to 115.2 N-m(85 ft-lb)
- Cup-type design, reduce the possibility to damage oil filters
- Material: Aluminum



KT NO.	Drive size	Diameter inch	Diameter mm	Flutes	Applicable models		
9AE1-6414 (Aluminum)	3/8"	2-1/2	64	14	TOYOTA 4 Cylinder (1800CC,2000CC) ,ALLION, AURIS, COROLLA AXIO, ISIS, IST, COROLLA RUMION, COROLLA FIELDER, NOAH, PREMIO, PRIUS, VOXY, WISH, etc...	164	12 / 72

9AE2

3/8"

- 3/8" square drive
- Withstands up to 115.2 N-m(85 ft-lb)
- Coated with electro-black oxide finish for protection against rust
- Cup-type design, reduce the possibility to damage oil filters



KT NO.	Drive size	Diameter inch	Diameter mm	Flutes	Applicable models		
9AE2-6514	3/8"	2-9/16	65	14	Fits Nissan, Fiat Champ, Hasting. GM/AC, Wix, NAPA, Purolator, Daihatsu, Toyota, Nissan, etc...	220	12 / 72
9AE2-6567	3/8"	2-9/16 & 2-21/32	65 & 67	14	Fits same filters as made in Canada including, PH4386, PH4967, PH6017, PH6018, Daihatsu, Toyota, etc...	220	12 / 72
9AE2-6606	3/8"	2-19/32	66	6	Fiat(Punto, 1.2), Renault(Clio 1.2 Express, Kangoo. Rapid. Twingo), etc....	153	12 / 72
9AE2-7476	3/8"	2-29/32 & 3	74 & 76	15	Fits Fram, AC, Saturn, Opel, VW, Audi, Mercedes, etc....	167	12 / 72
9AE2-7608	3/8"	3	76	8	Fiat(z.B. Marea), Lancia(z.B. Delta), etc....	181	12 / 72
9AE2-7612	3/8"	3	76	12	Fiat(z.B. Ducato, Scudo, Ulysee),Renault, (Megane, Laguna, Espace III.), etc....	167	12 / 72
9AE2-7614	3/8"	3	76	14	Fits Champion, Champ Lee, Purolator, Mopar, VW, Porsche,Mercedes, BMW, Audi, Toyota, Opel, etc....	167	12 / 72
9AE2-8616	3/8"	3-3/8	86	16	Volvo(S40, S60, S70, S80) etc....	188	12 / 72
9AE2-8618	3/8"	3-3/8	86	18	VW. Golf.(MKIII. Tdi, Passat Tdi), Audi A6 Tdi, Renault(Clio, Rapid 1.9D, Laguna.Safrane. Espace 2.1D). Citroen, Peugeot, Renault, etc..	181	12 / 72
9AE2-9210	3/8"	3-40/64	92	10	Fiat, Cinquecento, Coupe, Croma, DAF, Fiat, Panda. Regata, Ritmo Fiat, Seicento. Tempra, Tipo, Lancia(Beta. Dedra. Kappa. Monte. Carlo. Prisma. Thema. Trevi), etc....	181	12 / 72
9AE2-9315	3/8"	3-21/32	93	15	Fits Casite, Champ, Champion, GM, Fram, Hastings,Purolator, Wix, Nissan, Volvo, Mazda, Audi, VW, Porsche, Renault, etc....	181	12 / 72
9AE2-9345	3/8"	3-21/32	93	45	VW-Audi.(TDi 2.4, 2.6, 2.8L), etc....	181	12 / 72
9AE2-9618	3/8"	3-3/4	96	18	Audi(A4 Tdi, VW Passat,97 Tdi), Renault (Laguna 2.2d. Safrane2.2D. Espace 2.2D. R19 2.2D. Rapid, Megane,1.9/2.1D. Tdi) etc..	208	12 / 72
9AE2-10615	3/8"	4-11/64	106	15	Fiat(Ducato 2.5D. Td), etc....	222	12 / 72
9AE2-10815	3/8"	4-8/32	108	15	Volvo(C70. S70. V70. Tdi. TD)(850 Tdi. TD) etc....	222	12 / 72
9AE2-10818	3/8"	4-8/32	108	18	Renault(Espace, Laguna, Master, Safrane, Traffic 2.4, 2.5, 2.8D. TD), etc....	222	12 / 72



Cup Type Oil Filter Wrench Set

9AE2002

3/8"

- 3/8" square drive
- Withstands up to 115.2 N-m(85 ft-lb)
- Coated with electro-black oxide finish for protection against rust
- Cup-type design, reduce the possibility to damage oil filters



2
PC.

KT NO.	Drive size	Diameter inch	Diameter mm	Flutes	Applicable models	g	1 / 40
9AE2-6514	3/8"	2-9/16	65	14	Fits Nissan, Fiat Champ, Hasting. GM/AC, Wix, NAPA, Purolator, Daihatsu, Toyota, Nissan, etc...	282	
9AE2-6567	3/8"	2-9/16 & 2-21/32	65 & 67	14	Fits same filters as made in Canada including, PH4386, PH4967, PH6017, PH6018, Daihatsu, Toyota, etc...		



Cup Type Oil Filter Wrench Set

9AE2004

3/8"

- 3/8" square drive
- Withstands up to 115.2 N-m(85 ft-lb)
- Coated with electro-black oxide finish for protection against rust
- Cup-type design, reduce the possibility to damage oil filters

4
PC.



KT NO.	Drive size	Diameter inch	Diameter mm	Flutes	Applicable models	g	1 / 20
9AE2-6606	3/8"	2-19/32	66	6	Fiat (Punto, 1.2), Renault (Clio1.2 Express, Kangoo, Rapid, Twingo), etc...	571	
9AE2-7608	3/8"	3	76	8	Fiat (z.B. Marea), Lancia (z.B. Delta), etc...		
9AE2-7614	3/8"	3	76	14	Fits Champion, Champ Lee, Purolator, Mopar, VW, Porsche, Mercedes-Benz, BMW, Audi (I.B.A3TD) Opel, etc...		
9AE2-9315	3/8"	3-21/32	93	15	Fits Casite, Champ, Champion, GM, Fram, Hastings, Opel, Mazda, Volvo, Mitsubishi, Purolator, Wix, Nissan, VW, Porsche, Renault, Ford, Honda, Audi, etc...		



Cup Type Oil Filter Wrench Set

9AE2016

3/8"

- 3/8" square drive
- Withstands up to 115.2 N-m(85 ft-lb)
- Coated with electro-black oxide finish for protection against rust
- 1 PC. 1/2"(F)x3/8"(M) adapter
- 1 PC. 3 legs oil filter wrench(63-102mm)

16
PC.



KT NO.	Drive size	Diameter inch	Diameter mm	Flutes	Applicable models	Kg 4.00	1 / 5
9AE2-6606	3/8"	2-19/32	66	6	Fiat(Punto, 1.2), Renault(Clio 1.2 Express, Kangoo. Rapid. Twingo), etc....		
9AE2-7476	3/8"	2-29/32 & 3	74 & 76	15	Fits Fram, AC, Saturn, Opel, VW, Audi, Mercedes, etc....		
9AE2-7608	3/8"	3	76	8	Fiat(z.B. Marea), Lancia(z.B. Delta), etc....		
9AE2-7612	3/8"	3	76	12	Fiat(z.B. Ducato, Scudo, Ulysee), Renault, (Megane, Laguna, Espace III.), etc....		
9AE2-7614	3/8"	3	76	14	Fits Champion, Champ Lee, Purolator, Mopar, VW, Porsche, Mercedes, BMW, Audi, Toyota, Opel, etc....		
9AE2-8616	3/8"	3-3/8	86	16	Volvo(S40, S60, S70, S80) etc....		
9AE2-8618	3/8"	3-3/8	86	18	VW. Golf.(MKIII. Tdi, Passat Tdi), Audi A6 Tdi, Renault(Clio, Rapid 1.9D, Laguna.Safrane. Espace 2.1D). Citroen. Peugeot, Renault, etc..		
9AE2-9210	3/8"	3-40/64	92	10	Fiat, Cinquecento, Coupe, Croma, DAF, Fiat, Panda. Regata, Ritmo Fiat, Seicento. Tempra, Tipo, Lancia(Beta. Dedra. Kappa. Monte. Carlo. Prisma. Thema. Trevi), etc....		
9AE2-9315	3/8"	3-21/32	93	15	Fits Casite, Champ, Champion, GM, Fram, Hastings, Purolator, Wix, Nissan, Volvo, Mazda, Audi, VW, Porsche, Renault, etc....		
9AE2-9345	3/8"	3-21/32	93	45	VW-Audi.(TDi 2.4, 2.6, 2.8L), etc....		
9AE2-9618	3/8"	3-3/4	96	18	Audi(A4 Tdi, VW Passat, 97 Tdi), Renault (Laguna 2.2d. Safrane 2.2D. Espace 2.2D. R19 2.2D. Rapid, Megane, 1.9/2.1D. Tdi) etc..		
9AE2-10615	3/8"	4-11/64	106	15	Fiat(Ducato 2.5D. Td), etc....		
9AE2-10815	3/8"	4-8/32	108	15	Volvo(C70. S70. V70. Tdi. TD)(850 Tdi. TD) etc....		
9AE2-10818	3/8"	4-8/32	108	18	Renault(Espace, Laguna, Master, Safrane, Traffic 2.4, 2.5, 2.8D. TD), etc....		
9AE423	3/8"	2-1/2~4	63~102	-	3 legged oil Filter Tool		
9AE221	1/2"	-	-	-	Adaptor 1/2" F x 3/8" M		



Cup Type Oil Filter Wrench

9AE0

1/2"

- 1/2" square drive
- Withstands up to 115.2 N-m(85 ft-lb)
- Cup-type design, reduce the possibility to damage oil filters
- Material: Aluminum



KT NO.	Drive size	Diameter inch	Diameter mm	Flutes	Applicable models		
9AE0-6414 (Aluminum)	1/2"	-	64	14	TOYOTA.NISSAN	93	1 / 100
9AE0-7414 (Aluminum)	1/2"	-	74	14	AUDI. VW. OPEL. BMW. AUSTIN. 2003+FORD	118	1 / 100

9AE6

1/2"

- 1/2" square drive
- Withstands up to 115.2 N-m(85 ft-lb)
- Coated with electro-black oxide finish for protection against rust
- Cup-type design, reduce the possibility to damage oil filters



KT NO.	Drive size	Diameter inch	Diameter mm	Flutes	Applicable models		
9AE6-6514	1/2"	2-8/16	65	14	Fits Nissan, Fiat Champ, Hasting. GM/AC, Wix, NAPA, Purolator, Daihatsu, Toyota, Nissan, etc...	112	12 / 72
9AE6-6514A	1/2"	2-9/16	65	14	Fits Nissan, Fiat Champ, Hasting. GM/AC, Wix, NAPA, Purolator, Daihatsu, Toyota, Nissan, etc...	112	12 / 72
9AE6-6567	1/2"	2-9/16 & 2-21/32	65 & 67	14	Fits same filters as made in Canada including, PH4386, PH4967, PH6017, PH6018, Daihatsu, Toyota, etc...	222	12 / 72
9AE6-6606	1/2"	2-19/32	66	6	Fiat (Punto, 1.2), Renault (Clio 1.2 Express, Kangoo. Rapid, Twingo), etc...	222	12 / 72
9AE6-6814	1/2"	2-11/16	68	14	Fits Hastings, Mazda, Ford Escort, Capri, Subaru, Fran, PH6607 (Those Fram Filters Made in Korea), Motorcraft, FL816, etc...	222	12 / 72
9AE6-7314	1/2"	2-7/8	73	14	Fits Toyota/Lexus, etc...	222	12 / 72
9AE6-7414	1/2"	2-29/32	74	14	Audi, Volkswagen, BMW, Citroën, Peugeot, Ford, Fiat, Lancia, Mazda, Mercedes-Benz, Nissan, Vauxhall, Opel, Porsche, Renault, Suzuki, Toyota, etc...	153	12 / 72
9AE6-7415	1/2"	2-29/32	74	15	MF, Audi (#056-115-561g), GM. Rover, Chrysler, etc...	222	12 / 72
9AE6-7476	1/2"	2-29/32 & 3	74 & 76	15	Fits Fram, AC, Saturn, Opel, VW, Audi, Mercedes, etc...	243	12 / 72
9AE6-7577	1/2"	2-15/16 & 3-1/32	75 & 77	15	Fits VW, Audi, Casite, GM/AC, Hastings, Wix, NAPA, Ford, Isuzu, Mercedes, Opel, etc...	222	12 / 72
9AE6-7608	1/2"	3	76	8	Fiat (z.B. Marea), Lancia (z.B. Delta), etc...	222	12 / 72
9AE6-7612	1/2"	3	76	12	Fiat (z.B. Ducato, Scudo, Ulysee), Renault, (Megane, Laguna, Espace III), etc...	222	12 / 72
9AE6-7614	1/2"	3	76	14	Fits Champion, Champ Lee, Purolator, Mopar, VW, Porsche, Mercedes, Benz, BMW, Audi (I.B.A3TD) Opel, etc...	243	12 / 72
9AE6-7630	1/2"	3	76	30	Fits Motorcraft only-FL400A, Ford, etc...	243	12 / 72
9AE6-7815	1/2"	3-2/32	78	15	Nissan (#15028H8991), Ford, Toyota, Honda (Accord), etc...	243	12 / 72
9AE6-8015	1/2"	3-9/64	80	15	Fits Opel, Hastings, Fram, Purolator, Nissan, Honda, Motorcraft, Mazda, Isuzu, Subaru filters.	243	12 / 72
9AE6-8082	1/2"	3-9/64 & 3-7/32	80 & 82	15	Fits Wix Filters. Branded for: Mazda, Subaru, Toyota, Honda, Acura, Nissan, NAPA, etc...	243	12 / 72
9AE6-8414	1/2"	3-3/10	84	14	Mercedes Benz V6/V8 CDI models, etc...	194	12 / 72
9AE6-8616	1/2"	3-3/8	86	16	Volvo (S40, S60, S70, S80), etc...	180	12 / 72



Cup Type Oil Filter Wrench

9AE6

1/2"

- 1/2" square drive
- Withstands up to 115.2 N-m(85 ft-lb)
- Coated with electro-black oxide finish for protection against rust
- Cup-type design, reduce the possibility to damage oil filters



KT NO.	Drive size	Diameter inch	Diameter mm	Flutes	Applicable models	Weight	Quantity
9AE6-8618	1/2"	3-3/8	86	18	VW. Golf. (MKIII. TDi, Passat TDi), Audi A6 TDi, Renault (Clio, Rapid 1.9D, Laguna, Safrane, Espace 2.1D), Citroen, Peugeot, Renault, etc...	243	12 / 72
9AE6-9015	1/2"	3-17/32	90	15	Fits Honda (Accord). Mitsubishi. Mopar. Isuzu, etc...	180	12 / 72
9AE6-9210	1/2"	3-40/64	92	10	Fiat, Cinquecento, Coupe, Croma, DAF, Fiat, Panda, Regata, Ritmo Fiat, Seicento. Tempra, Tipo, Lancia (Beta. Dedra. Kappa. Monte. Carlo. Prisma. Thema. Trevi), etc...	260	12 / 72
9AE6-9315	1/2"	3-21/32	93	15	Fits Casite, Champ, Champion, GM, Fram, Hastings, Opel, Mazda, Volvo. Mitsubishi, Purolator, Wix, Nissan, VW, Porsche, Renault, Ford, Honda, Audi, etc...	260	12 / 72
9AE6-9336	1/2"	3-21/32	93	36	Fits Ford, Motorcraft only-FL1A, (FLA1B, FL300, FL820 Ford), etc...	260	12 / 72
9AE6-9345	1/2"	3-21/32	93	45	VW-Audi, (TDI 2.4, 2.6, 2.8L), etc...	260	12 / 72
9AE6-9515	1/2"	3-6/8	95	15	Toyota (#15600-41010) Alfa Romeo, GM, Ford, Chrysler.	260	12 / 72
9AE6-9618	1/2"	3-3/4	96	18	Audi (A4.A6, TDi), VW (Passat 97 TDi), Renault (Laguna 2.2D, Safrane 2.2D. Espace 2.2D.R19 2.2D. Rapid. Megane, 1.9/2.1D.TDi), etc...	260	12 / 72
9AE6-10015	1/2"	3-15/16	100	15	Fits Fram, Motorcraft, Wix, Isuzu, Mitsubishi, etc...	220	12 / 72
9AE6-10615	1/2"	4-11/64	106	15	Fiat (Ducato 2.5D.Td), etc...	190	12 / 72
9AE6-10815	1/2"	4-8/32	108	15	Volvo (C70.S70.V70.TDi.TD) (850 TDi. Turbo Diesel)	190	12 / 72
9AE6-10818	1/2"	4-8/32	108	18	Renault (Espace, Laguna, Master, Safrane, Traffic 2.4, 2.5, 2.8D. TD), etc...	190	12 / 72

Cup Type Oil Filter Wrench Set

9AE6002

1/2"

- 1/2" square drive
- Withstands up to 115.2 N-m(85 ft-lb)
- Coated with electro-black oxide finish for protection against rust
- Cup-type design, reduce the possibility to damage oil filters



2 PC.

KT NO.	Diameter inch	Diameter mm	Flutes	Applicable models	Weight	Quantity
9AE6-6514	2-9/16	65	14	Fits Nissan, Fiat Champ, Hasting. GM/AC, Wix, NAPA, Purolator, Daihatsu, Toyota, Nissan, etc...	282	1 / 40
9AE6-6567	2-9/16" & 2-21/32	65 & 67	14	Fits same filters as made in Canada including, PH4386, PH4967, PH6017, PH6018, Daihatsu, Toyota, etc...		



Cup Type Oil Filter Wrench Set

9AE6030

1/2"

- 1/2" square drive
- Withstands up to 115.2 N-m(85 ft-lb)
- Coated with electro-black oxide finish for protection against rust
- Cup-type design, reduce the possibility to damage oil filters
- Suitable for 3/8" or 1/2" drive tool

30 PC.



KT NO.	Drive size	Diameter Inch	Diameter mm	Flutes	Applicable models	Weight	Quantity
9AE6-6514	1/2"	2-8/16	65	14	Fits Nissan, Fiat Champ, Hasting. GM/AC, Wix, NAPA, Purolator, Daihatsu, Toyota, Nissan, etc...	6.67	1 / 3
9AE6-6567	1/2"	2-9/16 & 2-21/32	65 & 67	14	Fits same filters as made in Canada including, PH4386, PH4967, PH6017, PH6018, Daihatsu, Toyota, etc...		
9AE6-6606	1/2"	2-19/32	66	6	Fiat (Punto, 1.2), Renault (Clio 1.2 Express, Kangoo, Rapid, Twingo), etc...		
9AE6-6814	1/2"	2-11/16	68	14	Fits Hastings, Mazda, Ford Escort, Capri, Subaru, Fran, PH6607 (Those Fram Filters Made in Korea), Motorcraft, FL816, etc...		
9AE6-7314	1/2"	2-7/8	73	14	Fits Toyota/Lexus, etc...		
9AE6-7415	1/2"	2-29/32	74	15	MF, Audi (#056-115-561g), GM, Rover, Chrysler, etc...		
9AE6-7476	1/2"	2-29/32 & 3	74 & 76	15	Fits Fram, AC, Saturn, Opel, VW, Audi, Mercedes, etc...		
9AE6-7577	1/2"	2-15/16 & 3-1/32	75 & 77	15	Fits VW, Audi, Casite, GM/AC, Hastings, Wix, NAPA, Ford, Isuzu, Mercedes, Opel, etc...		
9AE6-7608	1/2"	3	76	8	Fiat (z.B. Marea), Lancia (z.B. Delta), etc...		
9AE6-7612	1/2"	3	76	12	Fiat (z.B. Ducato, Scudo, Ulysee), Renault, (Megane, Laguna, Espace III), etc...		
9AE6-7614	1/2"	3	76	14	Fits Champion, Champ Lee, Purolator, Mopar, VW, Porsche, Mercedes, Benz, BMW, Audi (I.B.A3TD) Opel, etc...		
9AE6-7630	1/2"	3	76	30	Fits Motorcraft only-FL400A, Ford, etc...		
9AE6-7815	1/2"	3-2/32	78	15	Nissan (#15028H8991), Ford, Toyota, Honda (Accord), etc...		
9AE6-8015	1/2"	3-9/64	80	15	Fits Opel, Hastings, Fram, Purolator, Nissan, Honda, Motorcraft, Mazda, Isuzu, Subaru filters.		
9AE6-8082	1/2"	3-9/64 & 3-7/32	80 & 82	15	Fits Wix Filters. Branded for: Mazda, Subaru, Toyota, Honda, Acura, Nissan, NAPA. Etc...		
9AE6-8616	1/2"	3-3/8	86	16	Volvo (S40, S60, S70, S80), etc...		
9AE6-8618	1/2"	3-3/8	86	18	VW, Golf. (MKIII, TDi, Passat TDi), Audi A6 TDi, Renault (Clio, Rapid 1.9D, Laguna, Safrane, Espace 2.1D), Citroen, Peugeot, Renault, etc...		
9AE6-9015	1/2"	3-17/32	90	15	Fits Honda (Accord). Mitsubishi. Mopar. Isuzu, etc...		
9AE6-9210	1/2"	3-40/64	92	10	Fiat, Cinquecento, Coupe, Croma, DAF, Fiat, Panda, Regata, Ritmo Fiat, Seicento, Tempra, Tipo, Lancia (Beta, Dedra, Kappa, Monte, Carlo, Prisma, Thema, Trevi), etc...		
9AE6-9315	1/2"	3-21/32	93	15	Fits Casite, Champ, Champion, GM, Fram, Hastings, Opel, Mazda, Volvo, Mitsubishi, Purolator, Wix, Nissan, VW, Porsche, Renault, Ford, Honda, Audi, etc...		
9AE6-9336	1/2"	3-21/32	93	36	Fits Ford, Motorcraft only-FL1A, (FLA1B, FL300, FL820 Ford), etc...		
9AE6-9345	1/2"	3-21/32	93	45	VW-Audi, (TDi 2.4, 2.6, 2.8L), etc...		
9AE6-9515	1/2"	3-6/8	95	15	Toyota (#15600-41010) Alfa Romeo, GM, Ford, Chrysler.		
9AE6-9618	1/2"	3-3/4	96	18	Audi (A4, A6, TDi), VW (Passat 97 TDi), Renault (Laguna 2.2D, Safrane 2.2D, Espace 2.2D, R19 2.2D, Rapid, Megane, 1.9/2.1D, TDi), etc...		
9AE6-10015	1/2"	3-15/16	100	15	Fits Fram, Motorcraft, Wix, Isuzu, Mitsubishi, etc...		
9AE6-10615	1/2"	4-11/64	106	15	Fiat (Ducato 2.5D, Td), etc...		
9AE6-10815	1/2"	4-8/32	108	15	Volvo (C70, S70, V70, TDi, TD) (850 TDi, Turbo Diesel)		
9AE6-10818	1/2"	4-8/32	108	18	Renault (Espace, Laguna, Master, Safrane, Traffic 2.4, 2.5, 2.8D, TD), etc...		
9AE433	1/2"	2-9/16~4-23/32	65~120		3 legged oil Filter Tool		
9AE221	1/2"	-	-	-	Adaptor 1/2" F x 3/8" M		



Oil Filter Socket Set

9AE8006

3/8"

- 3/8" square drive
- The set includes sizes 24, 27, 30, 32, 36 and 38mm
- 6 PC. oil filter sockets designed for removal of oil filter canisters and covers
- Withstands up to 115.2 N-m(85 ft-lb)

6
PC.



KT NO.



Applicable models

1.11 12 / 24

KT NO.	Drive size	Flutes	Applicable models
9AE8-24	3/8"	6	Audi BMW: 5 / 7 Series (N62) V8 engines from 2004 onward Cadillac: ATS 36
9AE8-27	3/8"	6	BMW, Ford, Fiat, GM, Renault, VAG, PSA Mercedes-Benz: A-CLASS Nissan: 1.5 / 1.9 / 2.2 / 2.5 dCi engines
9AE8-30	3/8"	6	Audi, Skoda, Seat, VW
9AE8-32	3/8"	6	GM, VAG BMW: 335D, X5 35d(09~10), X5 xDrive 35d(11~13) Opel / Vauxhall: Astra-G, Corsa-B, Zafira
9AE8-36	3/8"	6	Audi: A3 2.0(04~08), A4 2.0(04~08) BMW: M52, M54, M60, M62, M70 & M73 engines Ford: Mondeo 2.0D 16V Dura Torq engines, Transit 2.5 & 2.0 diesel engines Jaguar: 2.2D engines Mercedes-Benz: 116MB engine Vito CDI Mini: R56 Opel / Vauxhall: Omega DL 16V, Vectra 2.0, Zafira VAG: VAG 1.9 SDi (ASY), Golf GTI 2.0, Passat 2.0, VR6 Volvo
9AE8-38	3/8"	6	BMW, Volvo Opel / Vauxhall: Vectra 2 liter diesel engines



Three-Legs Oil Filter Wrench

9AE42

- The claw-type filter is available for removing all oil filters from 2-1/2" to 4" (63-102mm) in diameter
- Suitable for 3/8" or 1/2" square drive tool
- Coated with electro-black oxide finish for protection against rust
- **CW & CCW direction**

KT NO.	A B		Ø Capacity		Scales	Boxes
	inch	inch	inch	mm		
9AE42	1/2	3/8	2-1/4~4	63~102	395	12 / 48
9AE221	1/2	3/8	-	-	39	-
9AE433	1/2	3/8	2-9/16~4-23/32	65~120	502	12 / 36

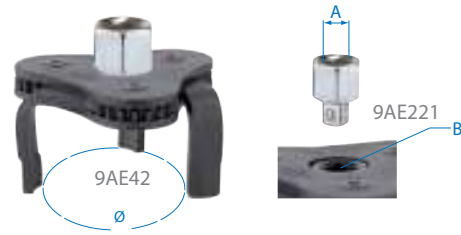

9AE43

- The claw-type filter is available for removing all oil filters from 3" to 4-3/4" (75-120mm) in diameter
- Suitable for 3/8" or 1/2" square drive tool
- Heavy duty design
- **CW & CCW direction**

KT NO.	A B		Ø Capacity		Scales	Boxes
	inch	inch	inch	mm		
9AE43	1/2	3/8	3~4-3/4	75~120	604	1 / 36

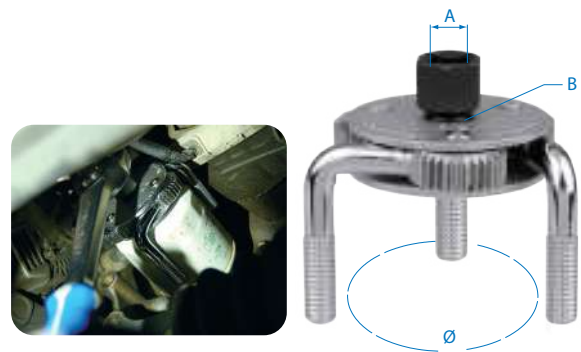

Two Jaws Oil Filter Wrench

9AE52

- The two jaws oil filter wrench is capable of removing all kinds of oil filter
- Suitable for using with 1/2" square drive tool
- Lost wax coating with electro-black oxide finish for protection against rust
- Specially teeth designed steel jaws

KT NO.	A		Ø Capacity		Scales	Boxes
	inch	inch	inch	mm		
9AE52	1/2		2-3/8~3-1/8	60~80	470	1 / 16
9AE52-110	1/2		3-1/8~4-5/16	80~110	985	1 / 12

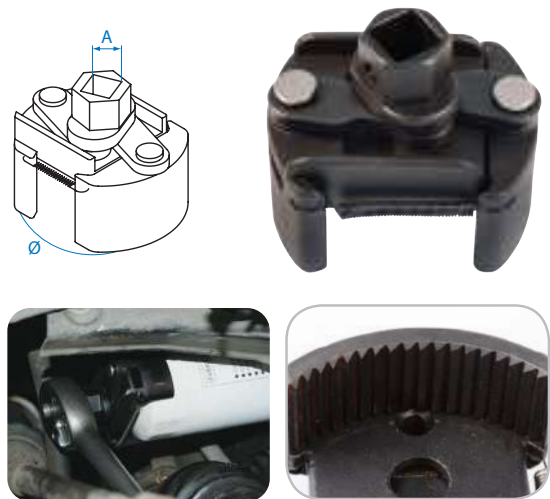

9AE53

- The claw-type filter is available for removing all oil filters from 3-1/8" to 4-1/2" (80-115mm) in diameter
- Suitable for using with 1/2" square drive tool
- Coated with electro-black oxide finish for protection against rust

KT NO.	A		Ø Capacity		Scales	Boxes
	inch	inch	inch	mm		
9AE53-115	1/2		3-1/8~4-1/2	80~115	667	6 / 24



Adjustable Oil Filter Pliers

9AE71

- Adjustable sizes from 60 to 140mm
- Serrated jaws



KT NO.	L		Ø Capacity mm	g	PC.
	inch	mm			
9AE71-90	9	230	60-90	357	12 / 72
9AE71-115	10	260	85-115	400	12 / 60
9AE71-140	14-1/2	365	100-140	897	1 / 20



Locking Grip Oil Filter Pliers

9AE72

- Lock and grip oil filters or any irregular shaped object for quick tightening or removal
- Use for adjusting and fastening at any angle

KT NO.	L		Ø Capacity mm	g	PC.
	inch	mm			
9AE72	10	254	53-118	458	12 / 48

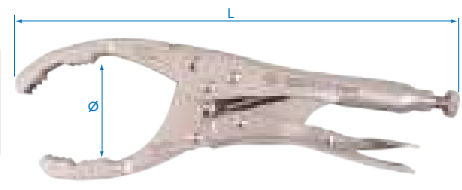

Hose Pinch & Set

9AF11

- Adjustable edges ensure no damage to hose
- For hoses from Ø15 mm up to Ø60 mm
- Suitable for clamping radiator, heater, fuel, coolant and brake hoses



KT NO.	L		Ø Capacity mm	g	PC.
	inch	mm			
9AF11-15	6-1/8	155	15	44	12 / 48
9AF11-30	7-9/32	185	30	76	12 / 48
9AF11-60	10	253	60	125	12 / 48



9AF113

- Adjustable edges ensure no damage to hose
- For hoses from Ø15 mm up to Ø60 mm
- Suitable for clamping radiator, heater, fuel, coolant and brake hoses

g 245 PC. 12 / 48



9AF11-60



9AF11-30



9AF11-15

3 PC.



Fuel Gauge & Pump Sender Collar Wrench

9AG11

- Use for removing and fitting fuel gauge sender collars to avoid damage
- 3 jaws to ensure high torque and no risk to damage plastic collar
- Use with 19mm wrench or socket
- Suitable for most collars from 89 to 170mm



KT NO.	Ø mm	kg	/
9AG11	89~170	1.05	1 / 12

Adjustable Fuel Tank Lid Remover

9AG13

- Use for removing and fitting fuel gauge sender collars to avoid damage
- Special jaws design, no risk to damage plastic collar
- Use with 3/8" DR.
- Suitable for collars from 122 ~ 199mm

560 / 1 / 24

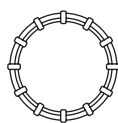

BMW



BENZ

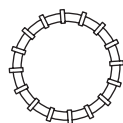

VW . AUDI
BENZ . BMW



Diesel Injector Extractor Tool

9AN021

- Use to remove injectors without dismantling the engine
- Suitable for Bosch injectors in Mercedes-Benz CDI engines 2.1 L and 2.2 L
- Application : Benz for Vito, Sprinter, Viano, C class, E class, CLC, CLK

2 / 1 / 6



6 in 1 Fly Wheel Puller

9XAH1

- This tool is designed to offer 6 different sizes for the Flywheel wheel rings on motorcycles
- Sizes include: M20 x 1.5R / M14 x 1.5R / M16 x 1.5R / M18 x 1.5R / M24 x 1.0R / M27 x 1.0L

730 / 1 / 24

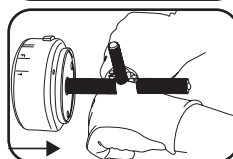
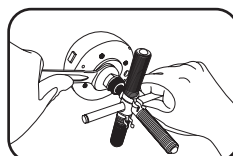

Valve Spring Compressor Set

9AH31

- Use for compress of motorcycle or small engines valve spring
- Adapter size: 16, 19, 23, 25, 30mm
- Capacity: 130mm
- Throat depth: 100mm

 1.31  /  1 / 12

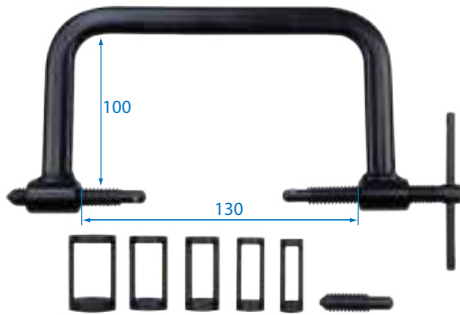

9AH12

- Complete service tool set for OHV & OHC petrol or diesel engines on Audi, Nissan, Toyota, Chrysler, Honda, Mazda, Mitsubishi, Saturn, Lexus, Hyundai, Infiniti, Porsche, Volvo, VW

 3.75  /  1 / 5

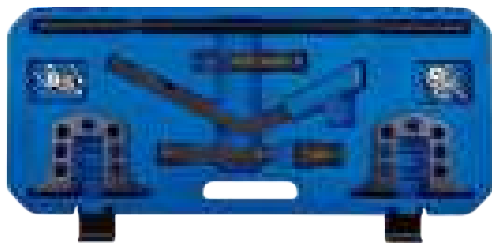

10
PC.



Valve Spring Compressor Set

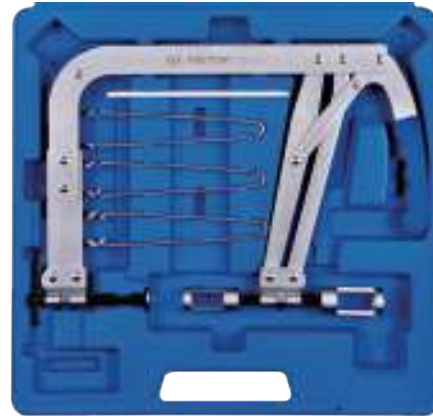

9AH025

- Suitable for large engines & diesel engines
- Capacity: 35~140mm
- Unique direct action compressor lever gives improved visibility & ease of using in areas of difficult access
- Dual size in 25 and 30mm adapter

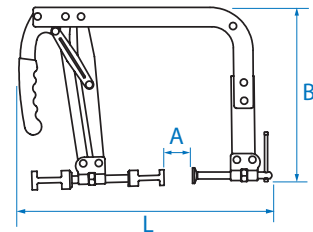

5
PC.



KT NO.	A mm	B mm	L mm		 / 
9AH025	35~140	280	390	5	1 / 5



Valve Lappers

9AH0311

- For hand lapping valves

 100  /  12 / 108

2
PC.



KT NO.	Diameter Cups Size	
9AH0311	1-1/8" (29mm) 5/8" (16mm)	1-3/8" (35mm) 13/16" (21mm)



Heavy Duty Air Valve Lapper Set

9AH0321

- Design for operating in tough environments
- Adjustable speed regulator for precise control during operation
- Complete with rubber caps of 20, 30, 35, 45mm

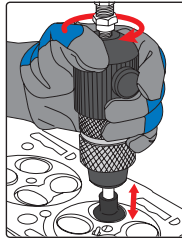

5 PC.

KT NO.	Free Speed R.P.M	Pistone Stroke inch mm	Overall Length inch mm	Air Inlet inch	Air Hose ID	Average Air Consumption CFM L/min	kg	1 / 10
9AH0321	5600	1.1 29	9.0 228	1/4	3/8	2.5 71	1.82	1 / 10

Oscillating Valve Lapping Tool

9AH0331

- Facilitates the easy insertion of valves
- Automatic change in direction
- Use with fine grinding paste
- Two different suction cups: 22mm / 28mm
- Working speed(Max):1000rpm

287 10 / 40

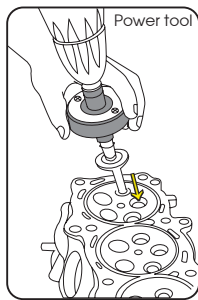

Cylinder Head Surface Rectifier

9AH41

- Precise test for engine block and cylinder head when reassembling or overhauling an engine
- Work with a feeler gauge
- Suitable for 4 and 6 cylinder engine
- Refer to automotive manufacturer's service manual for the minimum clearance
- Size : 600(L) x 36(W) x 16(H) mm

4.08 1 / 5

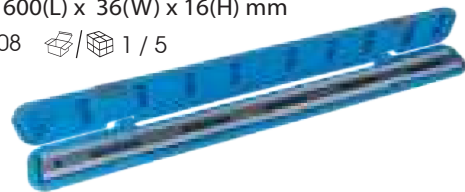

Universal Clutch Aligner Set

9AK11

- Designed to make alignment and assembly of clutch
- Specially designed for those vehicles equipped with late-model front wheel drives without pilot bearing in flywheel

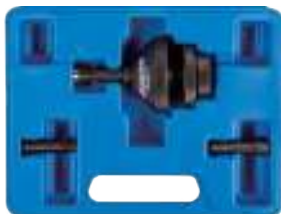

3 PC.

CONTENTS :

- 9AK11P03
Ø 23 ~ 27mm
- 9AK11P02
Ø 19 ~ 23mm
- 9AK11P01
Ø 15.5 ~ 20mm

KT NO.	∅ mm	kg	1 / 20
9AK11	15.5~27	0.60	1 / 20

Oxygen Sensor Socket

9AJ3122

3/8"

- For installing and removing oxygen sensors
- Offset design for confined areas

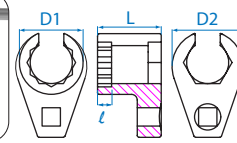

KT NO.	∅ mm	D1 mm	D2 mm	l mm	L mm	kg	1 / 100
9AJ3122	22	34	38	8	34	178	1 / 100

9AJ4322

1/2"

- For oxygen sensors
- Featuring a slot for the connecting lead

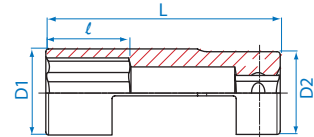

KT NO.	∅ mm	D1 mm	D2 mm	l mm	L mm	kg	5 / 60
9AJ4322	22	32	30	30	85	294	5 / 60

Oxygen Sensor Socket Set

9AJ017

3/8"+1/2"

- 7 PC. special sockets for removing oxygen sensors
- Suitable for most vehicles : Volkswagen, BMW, PSA, Mercedes-Benz, Ford, etc...

2.33 kg / 1 / 10

KT NO.	Part.	Size	mm
9AJ4229		1/2"	29
9AJ3322		3/8"	22
9AJ4227		1/2"	27
9AJ3222		3/8"	22
9AJ3127		3/8"	27
9AJ4122		1/2"	22
9AJ3122A		3/8"	22

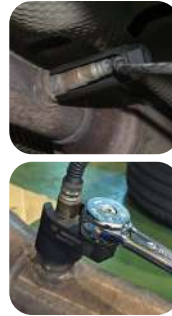

7 PC.

Diesel injection Socket

9AN4128

- Suitable for Alfa Romeo, Chrysler, Land Rover, Rover, etc...

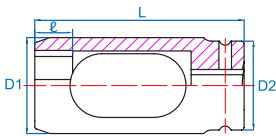

KT NO.	mm	D1 mm	D2 mm	l mm	L mm	g	kg
9AN4128	28	38.1	35.2	15	83	339	5/60



9AN4227

- Suitable for BMW, Fiat, Ford, etc...

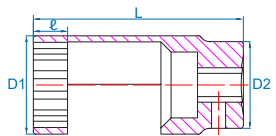

KT NO.	mm	D1 mm	D2 mm	l mm	L mm	g	kg
9AN4227	27	36.5	32.2	12.7	78	209	5/60



Man & Benz Truck Diesel Injection Valve Socket

9AN43

- The tool is designed to remove and install diesel injection valve
- Application: MAN 422/403, BENZ Truck, SCANIA

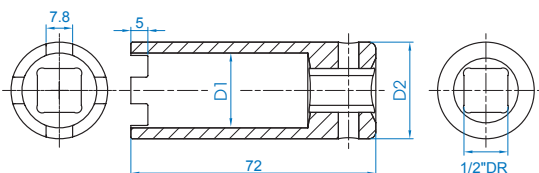

KT NO.	D1 mm	D2 mm	Tooth	g	kg
9AN43	22	28.4	4	181	10 / 80



Self Adjusting Clutch Alignment Setting Tool Set

9AK21

- Prevent damage to system and to keep adapter ring in right position
- Necessary for pre-tensioning self adjusting clutches before removal or installation, avoiding clutch deformation
- Prevents plate distortion
- Suitable for most SAC(Self Adjusting Clutches 3 and 4 holes) equipped on vehicles of FIAT GROUP, VW, AUDI, BMW, Mercedes-Benz, VOLVO, OPEL, RENAULT etc

⚖️ 10.75 📦 1 / 2



38 PC.



Pulley Removing Wrench

9AL

- To lock the pulley during removing or assembling any type of pulley retaining bolt

KT NO.	L		∅ mm	⚖️	📦
	inch	mm			
9AL11	14-3/8	365	40~140	540	12 / 36
9AL12	14-3/8	365	40~140	540	12 / 36

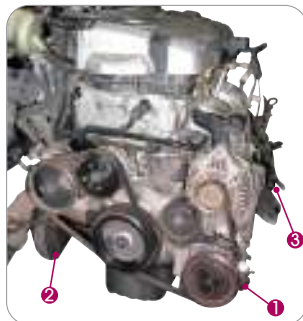
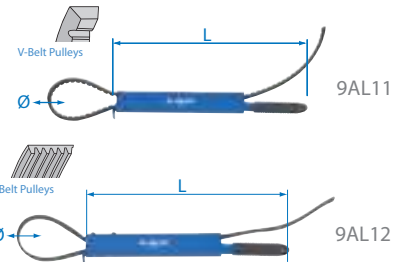

• Compressors



• Water pump pulley



• Alternator pump pulley



• Oil filter removal & assembly

Universal Cooling Pump and Refiller Tool Set



DO NOT open the radiator cap on a hot engine

9AM01

- For testing leakage in radiator system
- Vacuum leakage testing and bubble-free refilling
- Special pick hooks to speed up replacement of pipes
- Quick-release coupling on each connections
- Rubber cones with functional diameter 17~40mm



7 PC.

KT NO.	Type	⚖️	📦
9AM010	Japan	3.40	1 / 5
9AM011	USA	3.40	1 / 5
9AM012	Europe	3.40	1 / 5



Piston Ring Pliers

9AP

- For removing and mounting piston rings
- Nickel plated



KT NO.	L		Ø Capacity mm	Scales	Box / Carton
	Inch	mm			
9AP100	8-11/32	212	50~100	323	12 / 48
9AP120	8-15/16	227	80~120	354	12 / 48
9AP160	9-61/64	253	110~160	458	12 / 48

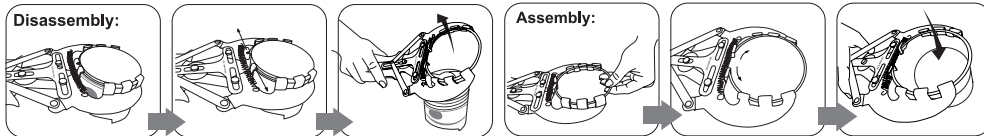
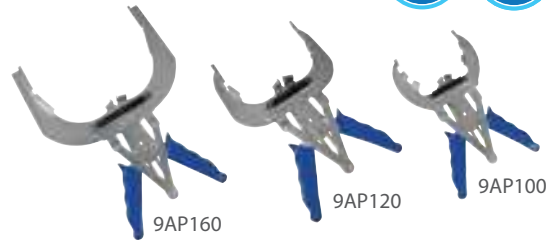

Drain Plug Removal Tool

9AR21

3/8"

- Use for removing and installing of the plastic oil drain plug on the latest VAG vehicle
- 3/8" DR and HEX 17 mm
- For VW, Audi, Skoda, Seat 1.2 / 1.4 / 1.8 / 2.0 TFSI oil drain plug and 1.6 / 2.0 TDI diesel engines cam cover plug

1.9kg 20 Box / Carton 12 / 288



Plastic Drain Plug

9AR29-S

- Suitable for VW, Audi, Skoda, Seat 1.2 / 1.4 / 1.8 / 2.0 TFSI oil drain plug and 1.6 / 2.0 TDI diesel engines cam cover plug
- Use with removal tool 9AR21
- OEM numbers 06L 103801

1.3kg 1 Box / Carton 1 / 144



Oil Drain Plug Key Set

9AR11

- Suitable for sump plugs on engine, gearbox and back axle
- Contents :
Hex key socket : H8, H9, H10, H12, H13, H14, H17 mm
Square socket : 5/16", 3/8", 7, 8, 10, 11, 12, 13, 14 mm
Torx socket : T45
Triangular socket : 10mm
Spline (TAMPER) socket : M16
Square drive socket : 10mm
3/8" drive sliding T-handle

1.70kg 1 Box / Carton 1 / 10



21 PC.

Diesel Injector Puller Set

9AS11

- The set contains M8, M12, M14, M17 adaptor
- Suitable for various vehicles with Bosch and Lucas type diesel injectors
- Remove stubborn diesel injectors easily and quickly
- New M17 adaptor for GM Vauxhall / Opel injectors X20DTH / Y20DTH series engines

1.11kg 1 Box / Carton 1 / 20



Why spark plugs need torque tightening ?



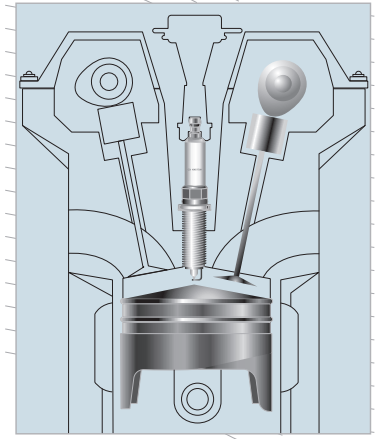

1. Modern engines cylinder heads are made of aluminium alloy
2. A correct factory-set gaps can provide best performance

Cylinder head material	Thread diameter (mm)				
	M8	M10	M12	M14	M18
Cast iron	-	10~15 N·m	15~25 N·m	25~35 N·m	35~45 N·m
Aluminium	8~10 N·m	10~12 N·m	15~20 N·m	25~30 N·m	35~40 N·m





Suggested torque for spark plugs with gasket, always follow factory owner's manual



3/8" Spark Plug Sockets

3/8" 	Size (inch)	Size (mm)	Type		Socket L(mm)			
					63	70	90	250
	9 / 16	14	6 pt	Rubber	36B514			
			12 pt	Rubber	36B014		36C014	36D014
			12 pt	Metal clip	367014			
	5 / 8	16	6 pt	Rubber		363516		
			12 pt	Rubber		363016		
			6 pt	Magnet		366516		
			12 pt	Magnet		366016		
	23 / 32	18	12 pt	Rubber	36B018			
			6 pt	Metal clip	367518			
			12 pt	Metal clip	367018			
	13 / 16	20.8	6 pt	Rubber		363521		
			12 pt	Rubber		363021		
			6 pt	Magnet		366521		
			12 pt	Magnet		366021		

1/2" Spark Plug Sockets

1/2" 	Size (inch)	Size (mm)	Type		Socket L(mm)
					70
	9 / 16	14	6 pt	Rubber	463514RC
			12 pt	Rubber	463014RC
	5 / 8	16	6 pt	Rubber	463516RC
			12 pt	Rubber	463016RC
			6 pt	Magnet	466516C
			12 pt	Magnet	466016
	23 / 32	18	6 pt	Magnet	
	13 / 16	20.8	6 pt	Rubber	463521RC
			12 pt	Rubber	463021RC
			6 pt	Magnet	466521C
			12 pt	Magnet	466021

Torque Wrench & Accessory

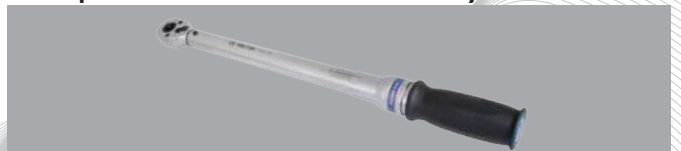

KT NO.	Gear Teeth	Square Drive	Torque Range in-lb / ft-lb	Incr.	Torque Range N·m	Incr.
34362-1CG	24	3/8"	40~200 in-lb	1 in-lb	5.1~22.0 N·m	0.12 N·m
34362-2CG	32	3/8"	15~80 ft-lb	0.5 ft-lb	23.7~105.1 N·m	0.7 N·m

KT NO.	Gear Teeth	Square Drive	Torque Range N·m	Incr.
34362-2DG	32	3/8"	20~100 N·m	0.5 N·m
34362-3DG	32	3/8"	10~60 N·m	0.5 N·m

KT NO.	Square Drive	Torque Range N·m	Torque Range ft-lb	Total Length kgf·m
34307-1A	3/8"	27~135 N·m	19.9~99.6 ft-lb	2.75~13.76 kgf·m

1/2" drive (M)	3/8" drive (F)	KT NO.	Spec.
		3814	3/8"F x 1/2"M

Spark Plug Rethreader Set

11305SQ

- Spark plug rethreader set is used for rethreading damaged spark plug threads in aluminum cylinder heads



KT NO.	Size mm	Type inch	g	kg
11305SQ	14	3/8, 7/16, 1/2, 3/4	13	12 / 72

Double Size "L" Handle

1586

- Material : Chrome vanadium alloy steel
- For oil plug



KT NO.	Overall length		Size		g	kg
	inch	mm	inch	mm		
1586-09	9	230	5/16 x 3/8	8 x 10	320	6 / 48

1596

- Material : Chrome vanadium alloy steel
- For oil plug



KT NO.	Overall length		Size		g	kg
	inch	mm	inch	mm		
1596-09	9	230	3/8	10	290	6 / 48

Ribe Socket M10S

9AW4911

1/2"

- 6 points
- Use for replacing and removing idler pulley center screw on TOYOTA ALTIS
- 1/2" DR. socket ribe M10S for TOYOTA

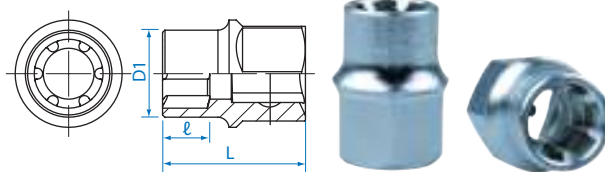

KT NO.	Size	D1 mm	ℓ mm	L mm	g	kg
9AW4911	M10S	19	10	33.8	16	10 / 200

Ribe Socket M12S

9AW4901

1/2"

- 6 points
- Use for replacing and removing engine head screw and flywheel center screw on NISSAN models
- 1/2" DR. socket ribe M12S for NISSAN

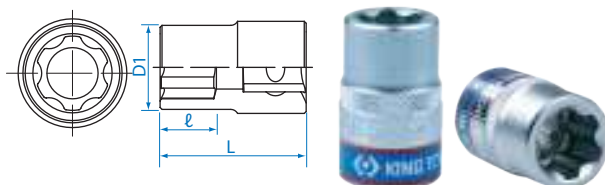

KT NO.	Size	D1 mm	ℓ mm	L mm	g	kg
9AW4901	M12S	22	14	38	15	10 / 200

Bearing Race and Seal Driver Set

9BA11

- Quick and easy to insert bearing race
- Collars fit most standard wheel bearing sizes
- Helps reduce damage to both race and axle housing
- 9 collar sizes:

- 1.574"/40mm
- 1.732"/44mm
- 1.968"/50mm
- 2.322"/59mm
- 2.480"/63mm
- 2.559"/65mm
- 2.834"/72mm
- 2.992"/76mm
- 3.189"/81mm

1.8 kg 1 / 10



10 PC.



Universal Bearing Ring Puller



9BA41

- Three jaws with the thin edge provide an equal grip tension to avoid any slide or tilt
- Suitable for all kind of bearing and sleeves diameter 10 to 125mm
- Applicable : For universal vehicles

KT NO.	Ø Capacity mm	kg	Box / Carton
9BA41	10~125mm	3.6	1 / 4



- Adjustable slide knob for quick control locking

Hose Clamp	KT Item	Suitable Car Brand
 CV Boot Clamp	9BB11 	VW, Audi, BMW, Ford, GM, Opel, Nissan, Mercedes- Benz, Mazda, Honda, Chrysler, Citroen, Seat
 Ear Clamp	9BB12 	
 CV Boot Clamp	9BB13 	
	9BB31 	Universal

Ear Hose Clamp Pliers

9BB11

- Use to remove and install ear clamp
- Special hook jaw easy to hold clamp in position
- Suitable for CV joint boot, vacuum lines, and cooling system

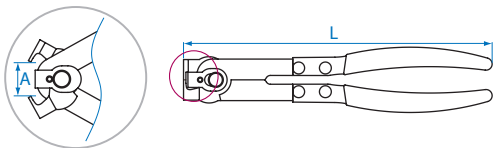

KT NO.	inch	L mm	A max mm	kg	Box / Carton
9BB11	10	260	22.5	364	12 / 48

CV Boot Clamp Pliers

9BB12

- Use to remove and install stainless CV boot clamp
- Can be used with 1/2" flexible handle bar or torque wrench
- Suitable for Audi, Opel, Citroen, SEAT, BMW, Mercedes-Benz, Honda, Nissan, Mazda, Ford, GM, Chrysler

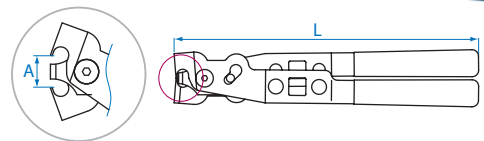

KT NO.	inch	L mm	A max mm	kg	Box / Carton
9BB12	9-1/2	235	12	512.4	6 / 36



CV Boot Clamp Pliers with Socket

9BB13

- Used to remove and install stainless CV boot clamp
- Can be used with 3/8" flexible handle bar or torque wrench
- Suitable for Audi, Opel, Citroen, SEAT, BMW, Mercedes-Benz, Honda, Nissan, Mazda, Ford, GM, Chrysler

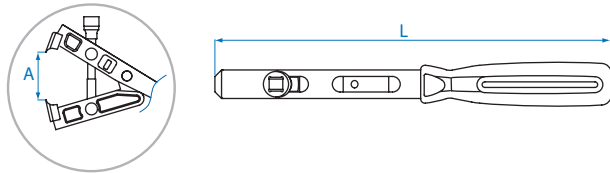

KT NO.	inch	L mm	A max mm	g	Box / Carton
9BB13	11	278	45	888	6 / 24

CV Boot Clamp Installer

9BB31

- Used to cut and install clamp with built-in cutting arm
- Includes locking device and ratchet function
- Suitable for general vehicle types

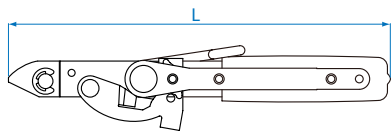

Lock



Cut



KT NO.	inch	L mm	g	Box / Carton
9BB31	6-1/2	124	347	12 / 36

CV Joint Assembly Removal Tool

9BB42

- Separates the CV Joint from the axle without removing the drive shaft
- Reduces the risk of damaging the transmission, or the CV joint
- Multiple hole pattern allows adjustment to different depths
- Suitable for most vehicles equipped with Constant Velocity U-joints

kg 1.77 Box / Carton 1 / 10

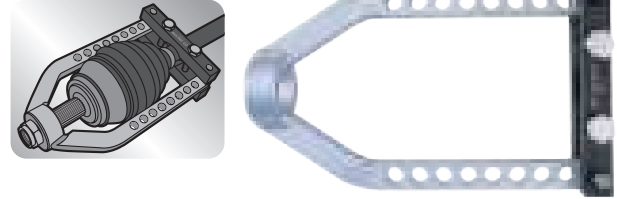

Exhaust Pipe Hanger

9BP11

- Used to remove rubber holders from exhaust brackets
- Suitable for general vehicle types

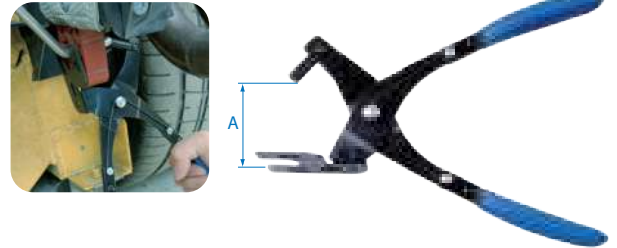

KT NO.	inch	L mm	A max mm	g	Box / Carton
9BP11	10	250	60	339	12 / 36

Exhaust Clamp Pliers

9BP21

- Used to remove and install exhaust clamps
- Include spring and locking mechanism
- Suitable for Citroen/Peugeot, Renault and prizing open types of exhaust clamps



KT NO.	inch	L mm	A max mm	g	Box / Carton
9BP21	12	300	60	496	12 / 36



Handbrake Cable Pliers

9BC11

- For hand brake cable removal and replacing
- Suitable for Audi, BMW, Citroen, Nissan, Peugeot, Seat, Renault, Rover, etc



KT NO.	inch	L mm	A max mm	B mm		
9BC11	9	230	60	5	198	12 / 48

Disc Brake Piston Separator

9BC21

- Heavy duty drop forged construction
- Fits in brake caliper to push back pistons for new brake pads installation



KT NO.	inch	Max capacity mm		
9BC21	2-7/8	75	1130	1 / 20

Drum Brake Spring Pliers

9BC121

- Designed to remove and replace brake retaining spring on drum brakes

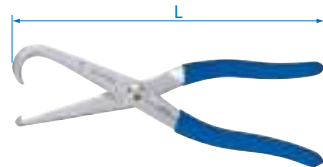
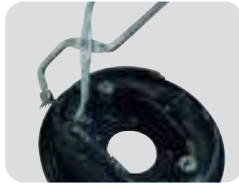

KT NO.	inch	L mm		
9BC121	8-1/2	215	305	6 / 72

Universal Disc Brake Wind-Back Tool Set

9BC22

- Magnetic socket adapter
- Including 9 adapters for brake assemblage
- For rotating pistons back into caliper to provide clearance for new pads
- Prevents damage to the piston and boot
- Suitable for VW, Audi, Ford, Nissan, Alfa romeo, Rover, Saab, Subaru, Toyota, Jaguar, and most of the general motors

2.87 1 / 6

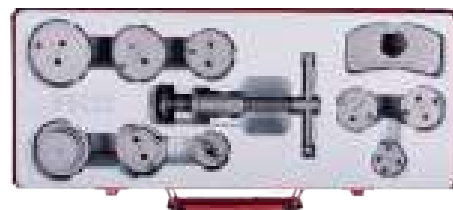

11 PC.



HGV Drum Brake Spring Pliers

9BC124

- Designed to remove and replace brake retaining spring on drum brakes
- Extra strong version for HGV air or hydraulic drum brakes

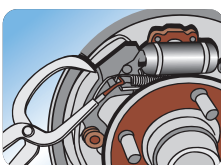

KT NO.	inch	L mm		
9BC124	20-5/8	525	1250	3 / 6



Universal Disc Brake Wind-Back Tool Set

9BC23

- For rotating pistons back into caliper to provide clearance for new pads
- Prevents damage to the piston and boot
- Suitable for BMW, Ford, VW, Audi, Porsche, Saab, Opel, Volvo, Jaguar, Citroen, Peugeot, Renault, Lauxhall, Lancia, Alfa romeo, Fiat, Nissan, Honda, Subaru, Toyota, Mitsubishi
- Contents:
 - 21 PC. Adapters for brake assemblage
 - 3 PC. Backing pads
 - 2 PC. Rotating caliper with 3/8" DR. (right/left side threaded)
 - 2 PC. Hex key: 7, 8mm
 - 2 PC. Pin punch : Ø 5.5, 6mm
 - 1 PC. 3/8" DR. x 12mm hex key socket

⚖️ 4.87 📦 1 / 4

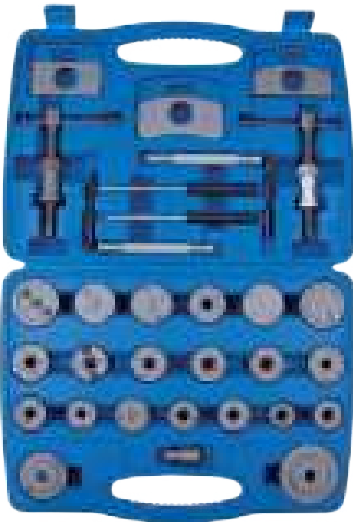

31 PC.



Brake Caliper Piston Tool

9BC24A

- For rotating pistons back into caliper to provide clearance for new pads
- Fast and easy to use, prevents damage to the piston and boot
- Fits most European and Japanese vehicles



3 PC.

KT NO.	Capacity		⚖️	📦
	A(mm)	B(mm)		
9BC24A	22	33	700	5 / 30



Pneumatic Disc Brake Wind-Back Tool

9BC251A01

- Designed to make disc brake services faster and energy saving
- Tool can be turned left and right ward - suitable for regular and reverse-threaded pistons
- Pneumatic powered tool is able to wind pistons back simply pressing a button

1.35 1 / 10

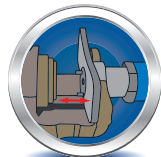

Increase the use of space



Magnetic



Pneumatic Disc Brake Wind-back Tool Set

9BC251

- Air operated ram applies pressure to caliper piston, while the handle is rotated by hand
- Easy to use- works on standard workshop air supply
- Reversible- works on both RH and LH applications
- Can be used on wind back and push back piston
- Supplied with adaptor, which covers a wide range of popular vehicles
- Full range of additional specialist adaptors available
- Suitable for Mercedes-Benz, BMW, Audi, VW, Opel, Volvo, Jaguar, Citroen, Fiat, Peugeot, Alfa romeo, Saab, Lancia, Toyota, Honda, Nissan, Mitsubishi, Isuzu, Mazda, Subaru, GM, Ford, Rover

3.20 1 / 5

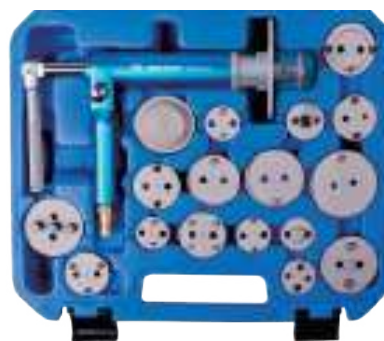
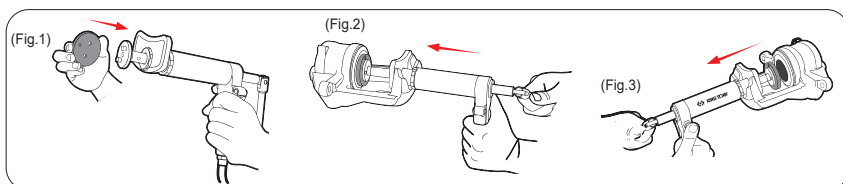

18 PC.

Universal Disc Brake Wind-Back Tool Set

9BC26

- Prevents damage to the piston and boot
- For rotating pistons back into caliper to provide clearance for new pads
- Suitable for FORD, ROVER, HONDA, Mercedes-Benz, TOYOTA, VW, AUDI, NISSAN, BMW, MAZDA, MITSUBISHI

1.38 1 / 12

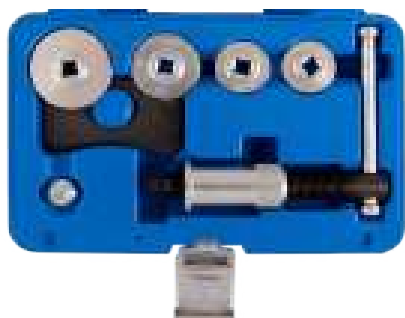

7 PC.

Brake Bleeder Valve Collection Bottle

9BC32

- It contains a brake oil check valve, a silicone hose, and a universal rubber adapter that is compatible with most vehicles
- Complete with a metal hanging hook
- Capacity : 1000 ml

420 1 / 12



CAUTION

Always keep the tool clean after using



Brake Bleeder Wrench Set

9BC5001MR

- Wrench size : 7, 8, 9, 10, 11mm
- Use on any vehicle, SUV, light truck or motorcycle brake caliper
- Combine wrench & socket to make loosening and tightening easily
- Ideal for bleeding brake system and hydraulic clutch system without removing the wheels
- High quality material internal seal to upgrade durability
- Silicone tube has the characteristics of acid and alkali proof, corrosion resistance, wear resistance, high and low temperature resistance
- Brake bleeder socket wrench prevents air backflow into brake system

6
PC.

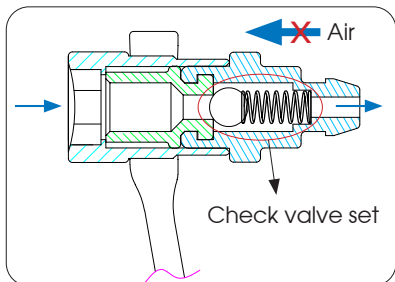

Blow case size (mm) :
260 x 160 x 60 (0.08 cuft)



Contents

0.73 kg / 1 / 10

	9BC5107M	7mm
	9BC5108M	8mm
	9BC5109M	9mm
	9BC5110M	10mm
	9BC5111M	11mm
	9BC32P021	

Universal Sleeve Removal and Installation Set

9BD101

- Can easily extract and draw in bearings, bushes, seals with this comprehensive tools
- Reduces the possibility of damaging the bearing/ suspension housings
- Tool doesn't designed to be used with the impact wrench

26
PC.

18.0 kg / 1 / 1

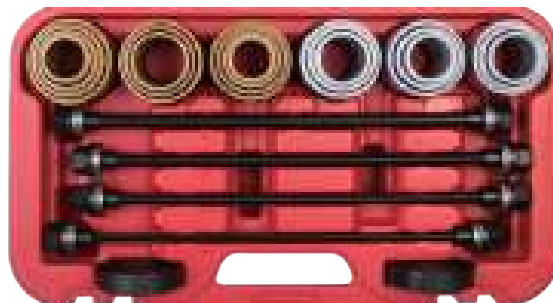
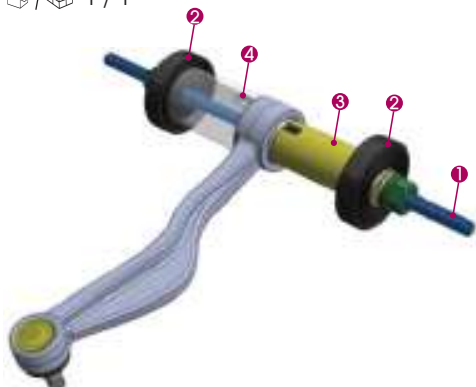

No.

1	M10 x P1.5 spindle and two fixing nuts with bearing
1	M12 x P2.0 spindle and two fixing nuts with bearing
1	M14 x P2.0 spindle and two fixing nuts with bearing
1	M16 x P2.5 spindle and two fixing nuts with bearing
2	Step discs with A and B sides (2 pcs)
3	Golden sockets (11 pcs) marked with A
4	Silver socket (9 pcs) marked with B

Socket sizes OD x ID mm

A	44 x 34 mm, 46 x 36 mm, 54 x 44 mm, 56 x 46 mm, 58 x 48 mm 66 x 56 mm, 68 x 58 mm, 70 x 60 mm, 78 x 68 mm, 80 x 70 mm 82 x 72 mm
B	48 x 38 mm, 50 x 40 mm, 52 x 42 mm, 60 x 50 mm, 62 x 52 mm 64 x 54 mm, 72 x 62 mm, 74 x 64 mm, 76 x 66 mm



Ball Joint Extractor

9BE11

- Drop forged steel body

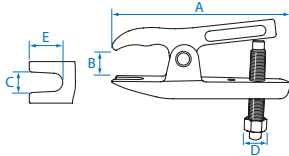

KT NO.	A mm	B(mm) Max	Min	C mm	D mm	E mm	⚖️	📦
9BE11	160	50	12	19	19	25	1080	1 / 12

9BE21

- Special design 2 stage operation, suits most cars and light trucks ball joints in steering & suspension
- Suitable for most European and Japanese vehicles

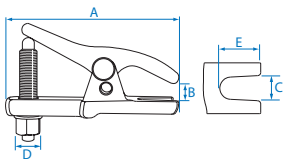

KT NO.	A mm	B(mm) Max	Min	C mm	D mm	E mm	⚖️	📦
9BE21	160	50	12	20	22	32	1270	1 / 12

9BE4

- For quick and easy separation of ball joint pivots of pitman arms, steering tie rods, ball joints, etc
- Suitable for general trucks and vehicles
- For better safety operation & avoid damage

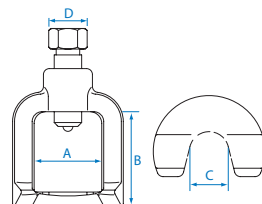

KT NO.	A mm	B mm	C mm	D mm	⚖️	📦
9BE41	36	40	18	17	364	1 / 36
9BE42	46	48	23	17	558	1 / 36
9BE43	62	62	29	19	925	1 / 12
9BE44	64	76	40	24	1658	1 / 12
9BE45	77	100	46	24	1858	1 / 12

Impact Ball Joint Separator

9HBE4

3/4"

- Use for quick separation of ball joint for heavy goods vehicle
- Extra deep design for tight space
- Use with impact tools



Heavy Goods Vehicle Ball Joint Separator

Size (mm)	Application
30	BMW (E39), Benz(W203/W210/W211/W220/W221), Mitsubishi Delica, Canter, Toyota Dyna etc...
39	"4 tons and European truck: Scania, Benz, MAN 414 drag link and Hino etc..."
47	"8.8 tons~10.5 tons truck: Hino, Isuzu, Nissan, UD,Fuso etc..."
58	Scania etc...
62	"15 tons~35 tons: Hino, Isuzu, Nissan, Fuso truck and bus etc..."
67	MAN(FE410A) etc...



KT NO.	A mm	B mm	⚖️	📦
9HBE4-30	30	95	2320	6 / 6
9HBE4-39	39	95	2320	6 / 6
9HBE4-47	47	95	2320	6 / 6



KT NO.	A mm	B mm	⚖️	📦
9HBE4-58	58	120	4200	6 / 6
9HBE4-62	62	120	4366	6 / 6
9HBE4-67	67	120	4200	6 / 6

Hydraulic HGV Ball Joint Separator & Set

9HBE81

- Use for separating ball joint for heavy goods vehicles
- Design for operating manually or by 12 tons hydraulic ram
- Strengthen fork and lever for greater force to be applied

7.00 1 / 2



capacity

Jaw opening 70mm
Jaw width 36mm



9HBE083

- Use for separating ball joint for heavy goods vehicles
- Design for operating manually or by 12 tons hydraulic ram
- Interchangeable jaws width : 30 / 34 / 40mm

8.50 1 / 2



Jaw Opening size :
30, 34, 40 mm



Track Rod End Remover & Installer

9BE51

- Removes and replaces the axial joint
- Hex part on the end of tool : works with 27 mm wrench or 1/2" DR. ratchet



KT NO.	inch	L mm	∅ Capacity mm		
new 9BE51	15-3/4	400	28~35	1635	1 / 10
9BE52	15-3/4	400	35~45	2140	1 / 10

Multi-Purpose Inner Tie Rod Tool

9BE62

9BE63

1/2"

- Use for replace inner tie rod ends without removing the rack and pinion
- Internal serrated design to make grip tight
- Use with ratchets and extensions by 1/2" DR.
- Suitable for most vehicles & trucks



KT NO.	inch	L mm	∅ Capacity mm		
9BE62	3-1/4	81.50	33~42	370	24
9BE63	3-7/16	87.56	42~50	422	24



Universal Adjustable Wheel Bearing Lock Nut Wrench

9HBN01

3/4"

- For disassemble and assemble vario nut and cap
- Extra slim design suitable to reach narrow space for special nut
- Use with 3/4" DR. tools and suggest to lock by torque wrench
- Application for 6PT, 8PT and round nut
- Adjustable open jaw 50~150mm

Contents:

3 pairs round adapter for round nut : 6mm, 8mm, 10mm

3 pairs square adapter for round nut : 1/4", 5/16", 3/8"

3.68 1 / 5



13 PC.

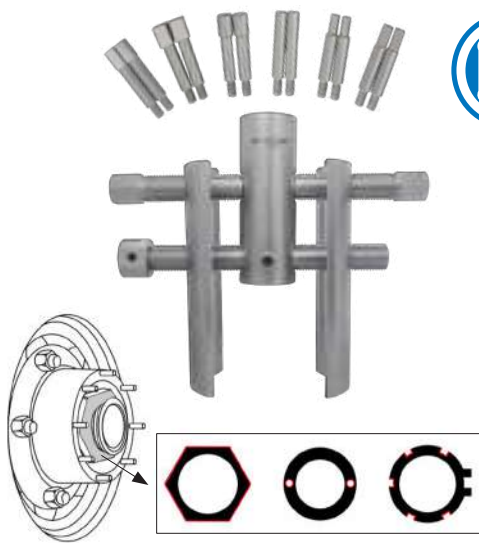

Drop Forged Coil Spring Compressor Set

9BF11

9BF21

- Drop forged SCM435 jaws & leaded screws
- Both 21mm 6-point sockets and 1/2" wrench are available
- Suitable for limited space under wheel arch

6 PC.



9BF11



9BF21



KT NO.	L mm	Socket	Wrench	Weight (kg)	Quantity
9BF11	85 / 370	1/2"	21	2.40	1 / 6
9BF21	85 / 270	1/2"	21	3.36	1 / 6

Coil Spring Compressor Set

9BF31

- Developed for "Macpherson" suspensions, using a range of 3 sets interchangeable monobloc forks
- Spring specification / use :
 - A : Ø80~115mm
 - B : Ø110~150mm
 - C : Ø140~195mm
- Suitable for BMW, Ford, VW, Audi, Porsche, Saab, Opel, Volvo, Nissan, Honda, Mitsubishi, Subaru, Toyota

8 PC.

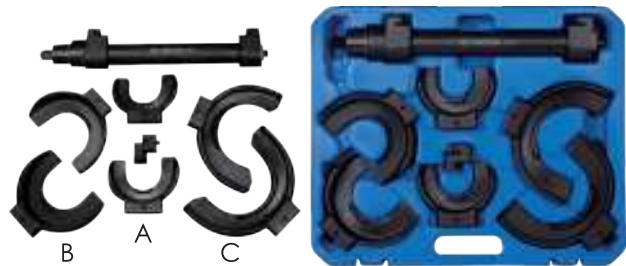

KT NO.	L mm	Capacity mm	Weight (kg)	Quantity
9BF31	460	40~300	15.00	1 / 1

Steering Wheel Puller Set

9BG11

- Easy to remove and install steering wheel for cars and trucks
- 2 sets 17mm hex head puller with pointed and flat cups
- 4 sets side bolts
- Small plate Dia. :
 - 1"~3-11/16" 25~95mm
- Large plate Dia. :
 - 1-1/8"~5" 28~125mm
- Side bolts size :
 - 3 PC. 5/16" UNC x 3-1/2" long puller bolts
 - 3 PC. 5/16" UNF x 3" long puller bolts
 - 3 PC. 3/8" UNC x 3" long puller bolts
 - 3 PC. 3/8" UNF x 3" long puller bolts

4.10 1 / 6



18 PC.

Coil Spring Compressor Set

9BF33

- Suitable for BMW, Audi, Chevrolet, Citroen, Fiat, Ford, Honda, Hyundai, Kia, Lancia, Mazda, Benz, Mitsubishi, Nissan, Opel, Peugeot, Renault, Seat, Tesla, Toyota, Volvo
- Can be operated with impact wrench
- Spring specification/use: 75~155 mm
- Stroke: 106~293 mm
- Max load: 6,400 kgf-m (62,765 N-m)

3
PC.

100kg 5.5  1 / 4



- Place upper and lower discs on spring



- Insert the main tool body into the spring



- Insert through the disc and make a half turn to connect the tool and disc



- Turn the hex nut on the main tool body lower end to fix all parts



- Use an air/impact wrench to compress the spring

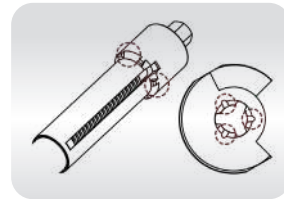



- Special pins on tool body to mesh with grooves on discs to create a secure connection

Wheel Balancing Weight Tool

9BK11

- Ideal for fitting and removing wheel balance weights

KT NO.	inch	L mm	A mm	B mm		
9BK11	10	250	22	86	420	10 / 50

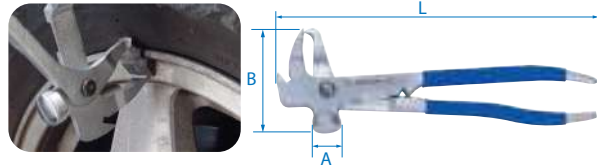

Tire Lever

9BK41

9BK43

- Straight pattern with profiled shank





9BK41



9BK43



KT NO.	inch	L mm	A mm	B mm		
9BK41-20	8	200	21.6	11	104	10 / 50
9BK41-28	11	280	22.7	13.5	239	10 / 50
9BK41-38	15	380	24.5	13.5	358	10 / 50
9BK41-53	21	530	28	12	930	10 / 20
9BK41-65	25	650	30	15	1075	10 / 20
9BK43-65	25	650	30	15	1100	10 / 20

Tire Valve Installer

9BK31

9BK32

- Use for replacement and fitting tire valves
- Composite body prevents damage onto alloy wheel
- 180 degree pivoting head
- 310mm plastic handle



9BK31
 118  12 / 144



9BK32
 353  6 / 48



- For removal & installing valve cores

Tire Lever

9BK41-73

- To install and remove the tire from wheel rim
- Precision forged with greater leverage design
- Special design for 17" to 22.5" tire

KT NO.	inch	L mm	A (mm)	B (mm)		
9BK41-73	28-3/4	730	22	64.4	1618	1 / 10

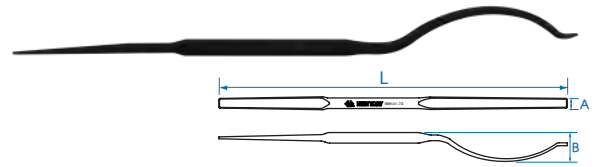

Tire Valve Core Torque Tool / Installer Torque Screwdriver

34102-040M

- Preset torque setting in order to remove & install valve cores correctly
- Prevent overloaded torque to cause damage on valves sensor cores
- Preset torque is 0.45 N·m (4.0 lbf·in)
- Ergonomics design with PP handle

62 20 / 100

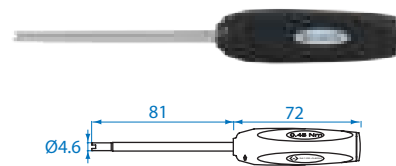

Digital Tire Gauge

9BM120

- Tyre pressure gauge specification :
Unit range :
0-100 psi / 0~7.0 bar / 0~7.0 Kgf-cm² / 0~700 kpa
Display resolution :
0.1 psi / 0.01 bar / 0.01 Kgf-cm² / 0.01 kpa
- Tread depth gauge specification :
Unit range : 0-22mm / .8"(Gauge : mm / inch)
Display resolution : 0.01mm / .001"

KT NO.	A mm	B mm	L mm		
9BM120	53	38	101	53	12 / 96

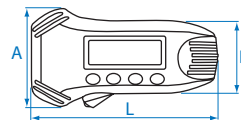

Digital Tire Tread Depth Gauge

9BM811

- Digital large LED LCD screen display
- Material : ABS Plastic, stainless steel needle
- One-touch switch between Metric / Inch system interchange
- Zero setting at any position
- Mini size, hand-held and portable
- Unit range : 0-25.4mm / 0-1"
- Display resolution : 0.01mm / .0005"

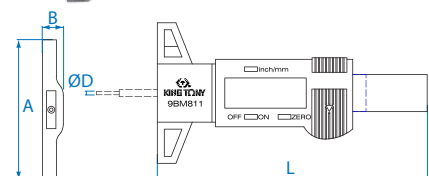

KT NO.	ØD mm	A mm	B mm	L mm		
9BM811	1.5	60	9	116	39.6	25 / 100



Tire Air Bead Seater

9HBL

- Capacity : 5 Gallon
- Used for seating tires for cars, trucks, ATVs, tractors
- Air gauge for easy and accurate air volume readings
- Can be used for tire sizes up to 24.5"

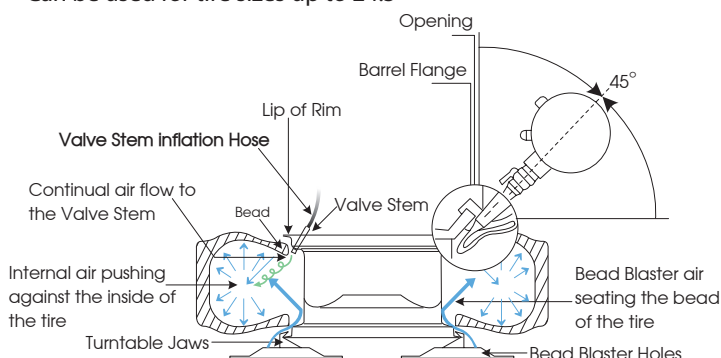

KT NO.	Type	Capacity	Max. pressure		
9HBL11-05	America	5 gallon	145 PSI	11.0	1
9HBL12-05	Europe	(20 L)	(10 bar)		

3-In-1 Inflator

9BM

- Diaphragm pressure gauge
- Accuracy : ANSI B40.100 ± 3% ~ ± 2% ~ ± 3%
- Special rubber housing protects manometer against light impacts
- 3 functions(check, release, inflator) all together on the press handle
- Variable trigger, two control position inflate / deflate leve
- Flexible 400MM high pressure rubber hose with clip-on air tire chuck
- Pressure range : 0-160 PSI (9BM21) / 0-220 PSI (9BM22)
- Built in hang-up hook allows easy storage

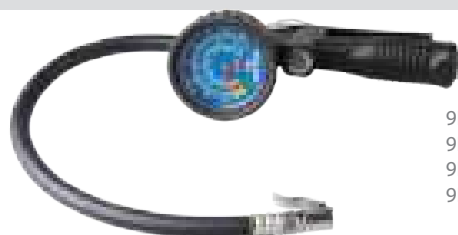
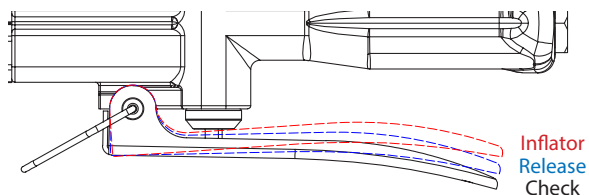

9BM2110
9BM2111
9BM2210
9BM2211



9BM2210A
9BM2211A

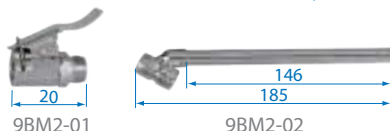
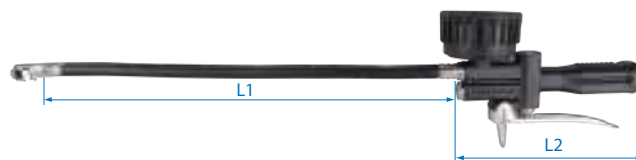

KT NO.	Pressure range (Psi)	Air Inlet (BSPT/NPT)	L (mm) L1	L2	Air hose (ID)		
9BM2110	160	1/4"-19 BSPT	Ø13 x 400	180	3/8"	500	1 / 12
9BM2111	160	1/4"-18 NPT	Ø13 x 400	180	3/8"	500	1 / 12
9BM2210	220	1/4" BSPT	Ø13 x 400	180	3/8"	520	1 / 12
9BM2211	220	1/4" NPT	Ø13 x 400	180	3/8"	520	1 / 12
9BM2210A	220	1/4" BSPT	Ø13 x 400	180	3/8"	600	1 / 12
9BM2211A	220	1/4" NPT	Ø13 x 400	180	3/8"	600	1 / 12
9BM2-01	(included in all 9BM series)		20	-	-	25	-
9BM2-02	(included in 9BM2210A & 11A only)		185	-	-	105	-



Wheel Lock Screw Socket Set

9BW0120

VW

- Used to permit servicing of customer vehicles, even lose the key
- Applicable for installing and removing locks of most VW models
- Chrome molybdenum, alloy steel chrome plated
- Work with 17mm hex tool
- Contents :
#521,#522,#523,#524,#525,#526,#527,#528,#529,#530,#531,#532,#533,#534,#535,#536,#537,#538,#539,#540

2.9 1 / 5

20 PC.

521	522	523	524	525
526	527	528	529	530
531	532	533	534	535
536	537	538	539	540



9BW0220

BMW

- Used to permit servicing of customer vehicles, even lose the key
- Applicable for installing and removing locks of most BMW models
- Chrome molybdenum, alloy steel chrome plated
- Work with 17mm hex tool
- Contents :
#041,#042,#043,#044,#045,#046,#047,#048,#049,#050,#051,#052,#053,#054,#055,#056,#057,#058,#059,#060

1.94 1 / 5

20 PC.

041	042	043	044	045
046	047	048	049	050
051	052	053	054	055
056	057	058	059	060



9BW0221

BMW

- Used to permit servicing of customer vehicles, even lose the key
- Applicable for installing and removing locks of most BMW models
- Chrome molybdenum, alloy steel chrome plated
- Contents :
#30/13PT, #31/15PT, #32/16PT, #33/17PT, #34/18PT, #35/19PT, #36/20PT, #37/21PT, #38/22PT, #40/23PT, #13/16PT, #12/14PT, #11/15PT, #16/10PT, #15/11PT, #14/12PT, #19/8PT, #18/13PT, #17/7PT, #20/9PT, #494517M (1/2"DR. x 17mm)

1.48 1 / 10

21 PC.

11/15PT	12/14PT	13/16PT	14/12PT	15/11PT
16/10PT	17/7PT	18/13PT	19/8PT	20/9PT
30/13PT	31/15PT	32/16PT	33/17PT	34/18PT
35/19PT	36/20PT	37/21PT	38/22PT	40/23PT



Locking Nuts & Bolt

WSB01

▪ Long Bolt

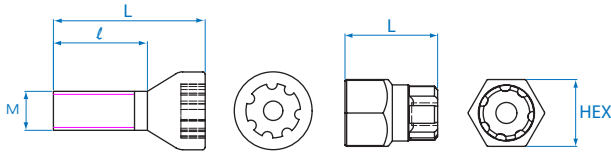

KT NO.	HEX	Thread M	l mm	L mm
WSB012802-5	-	M12 x 1.5	28	47
	13/16	-	-	29
WSB013006-5	-	M14 x 1.5	30	49
	13/16	-	-	29

WSN04

▪ Long Lock Nut

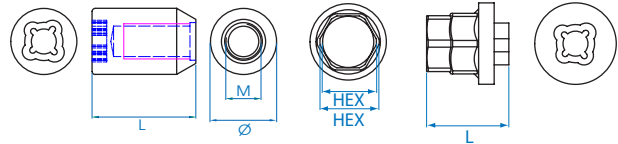

KT NO.	HEX	Ø	Thread M	L mm
WSN043601-5	-	23	M12 x 1.25	36
	19 x 13/16	-	-	28
WSN043602-5	-	23	M12 x 1.5	36
	19 x 13/16	-	-	28

WSN14

▪ Lock Nut

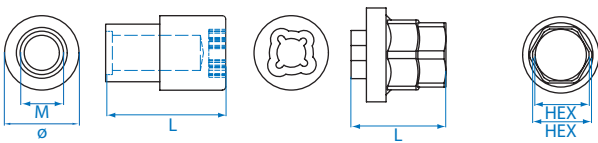

KT NO.	HEX	Ø	Thread M	L mm
WSN143601-5	-	23	M12 x 1.25	36
	19 x 13/16	-	-	28
WSN143602-5	-	23	M12 x 1.5	36
	19 x 13/16	-	-	28

WSB02

▪ Cone Seat Bolt Lock

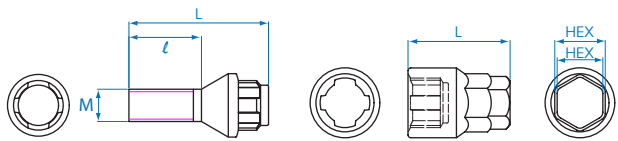

KT NO.	HEX	Thread M	l mm	L mm
WSB022701-5	-	M12 x 1.25	27.5	52.5
	17 x 3/4	-	-	38







- Material - chrome molybdenum alloy steel
- Finishing - phosphate sunk

Impact Socket for Hybrid Wheel Bolts Mercedes-Benz

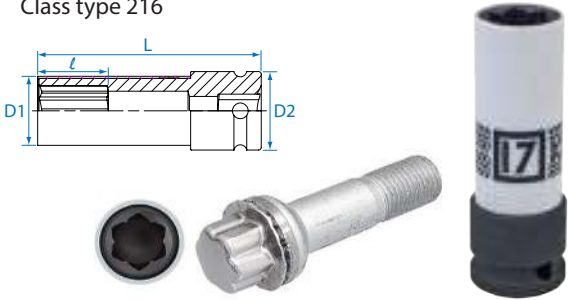
9BW4501  1/2"

- Durable outer sleeve protects polished wheels and lug nut
- Suitable for Hybrid wheel bolts on e.g. MERCEDES-BENZ C-Class type 204, 204X E-Class type 211, 212, 207 SLK type 172 M-Class type 164, 166 S-Class type 221, 222 CL-Class type 216







KT NO.	Size mm	D1 mm	D2 mm	ℓ mm	L mm			
9BW4501	17	26.4	30	26	85.5	229	5	60

Impact Socket for Special Profile Wheel Bolts

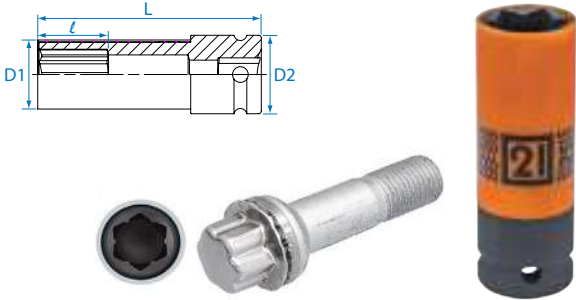
9BW4502  1/2"

- Durable outer sleeve protects polished wheels and lug nut
- Suitable for Wheel nuts with special profile 21 mm on HYUNDAI i30, Tucson and KIA







KT NO.	Size mm	D1 mm	D2 mm	ℓ mm	L mm			
9BW4502	21	28.5	30	26	85.5	252	5	60

10 Point Socket 20MM

9BW4801  1/2"

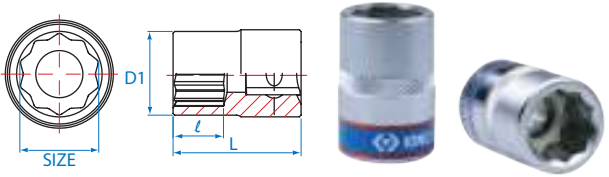

- 1/2" DR.
- 10 points
- Use for replacing and removing retaining screw on rear trailing arm on HONDA CR-V

KT NO.	 mm	D1 mm	ℓ mm	L mm			
9BW4801	20	25	15	38	88.0	10	160





Stud/Hub Cleaning Tool & Set

9BK72

KT NO.	inch	L	mm		
9BK72-12	7/16		12	25.2	100
9BK72-13	1/2		13	25.4	100
9BK72-14	9/16		14	25	100
9BK72-16	5/8		16	25.6	100
9BK72-22	7/8		22	33.6	100
9BK72-28	1-1/18		28	38	100



9BK73





KT NO.	mm		
9BK73-14	14	13.2	100
9BK73-22	22	13.8	100
9BK711	150	101.8	100



9BK7008

- For cleaning corrosion from studs, especially useful for cleaning around the base of studs
- Includes one quick change handle and adaptor

8
PC.







KT NO.	Contents	 545	 10
9BK72		12, 13, 14, 16, 22, 28	
7704-50		1/2"	
9BK711		1/2"	



9BK7009

- For cleaning corrosion from hubs and studs, especially useful for cleaning around the base of studs
- Includes one quick change handle and adaptor

8
PC.

KT NO.	Contents	 480	 10
9BK72		14, 22	
9BK73		14 x 2, 22 x 2	
7704-50		1/2"	
9BK711		1/2"	



Lubrication-Grease Gun

9BU11

- Ideal for machine, automobile, farm and garden equipments, other vehicles etc.

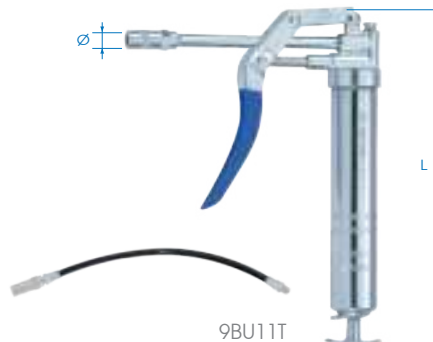

9BU11T

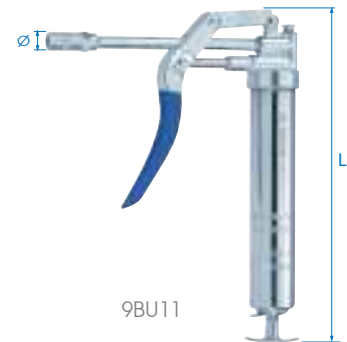

KT NO.	L		Ø Screw thread	High pressure		Capacity		Kg	/
	inch	mm		PSI	bar	c.c.	oz		
9BU111	10-5/8	267	1/8 x 28 PT	4000	275	120	3	0.61	1 / 30
9BU112	10-5/8	267	M10 x 1.0P	4000	275	120	3	0.61	1 / 30
9BU111T	10-5/8	267	1/8 x 28 PT	4000	275	120	3	0.68	1 / 30
9BU112T	10-5/8	267	M10 x 1.0P	4000	275	120	3	0.68	1 / 30

9BU111/ 9BU111T For general market except North America, Germany, South Africa, Egypt
 9BU112/ 9BU112T For Germany, South Africa, Egypt, etc.

Lubrication-Grease Gun with 12" Tube

9BU143T

- Ideal for machine, automobile, farm and garden equipments, other vehicles etc.



9BU153T



KT NO.	L		Ø Screw thread	High pressure		Capacity		Kg	/
	inch	mm		PSI	bar	c.c.	oz		
9BU1432T	14-1/2	368	M10 x 1.0P	7000	483	400	14	1.36	1 / 12

9BU1531T For general market except North America, Germany, South Africa, Egypt
 9BU1432T / 9BU1532T For Germany, South Africa, Egypt, etc.



Lubrication-Grease Gun

9BU2

- Ideal for machine, automobile, farm and garden equipments, other vehicles etc.

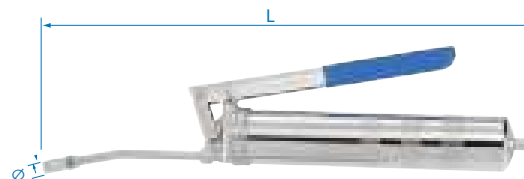

KT NO.	L		Ø Screw thread	High pressure		Capacity		Kg	/
	inch	mm		PSI	bar	c.c.	oz		
9BU241	14	360	1/8 x 28 PT	10000	700	400	14	1.18	1 / 16
9BU242	14	360	M10 x 1.0P	10000	700	400	14	1.18	1 / 16
9BU251	14.2	365	1/8 x 28 PT	10000	700	500	16	1.52	1 / 16
9BU252	14.2	365	M10 x 1.0P	10000	700	500	16	1.52	1 / 16

9BU241 / 9BU251 For general market except North America, Germany, South Africa, Egypt
 9BU242 / 9BU252 For Germany, South Africa, Egypt, etc.

Lubrication-Grease Gun with 12" Tube

9BU2T

- Ideal for machine, automobile, farm and garden equipments, other vehicles etc.



KT NO.	L		Ø Screw thread	High pressure		Capacity		Kg	/
	inch	mm		PSI	bar	c.c.	oz		
9BU241T	14	360	1/8 x 28 PT	10000	700	400	14	1.24	1 / 16
9BU242T	14	360	M10 x 1.0P	10000	700	400	14	1.24	1 / 16
9BU251T	14.2	365	1/8 x 28 PT	10000	700	500	16	1.63	1 / 16
9BU252T	14.2	365	M10 x 1.0P	10000	700	500	16	1.63	1 / 16
9BU8109	9	229	1/8 x 28 PT						
9BU8209	9	229	M10 x 1.0P						
9BU8112	12	305	1/8 x 28 PT						
9BU8212	12	305	M10 x 1.0P						

9BU241T / 9BU251T For general market except North America, Germany, South Africa, Egypt
 9BU242T / 9BU252T For Germany, South Africa, Egypt, etc.



Portable Bearing Packer

9BU41

- Quick and easy way to pack bearings with less mess
- Suitable for bearing diameter up to 90 mm
- Press the cap until old grease forced out and replaced by fresh grease

505.2 1 / 36



Oil Suction Gun

9BT2

- Designed for all purpose, quickly draining and filling oil and other fluids for clutches, agricultural, and industrial chemical, additives, transmission on differentials, brake master cylinders, oil filters or other type of sumps or sampling engine oil
- Features 11" flexible plastic hose



KT NO.	L		Capacity c.c.	oz	770	1 / 20
	inch	mm				
9BT250	13.4	340	500	16	770	1 / 20
9BT2100	17.3	440	1000	32	1238	1 / 20

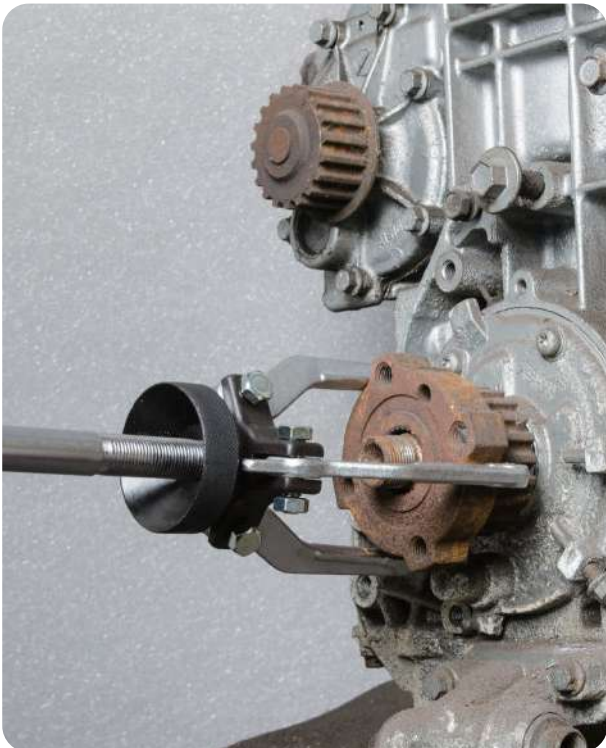

Slide Hammer Puller Set

9BQ01

- 5 lbs / 2.2 kgs slide hammer with 500 mm shaft make more powerful
- Three types to use : internal/external puller, plate puller, dent puller
- Use for remove vehicle Hub, rear axle, bearing or repair dent, etc.

7.5 1 / 2



17
PC.

CONTENTS:

- 1 PC. 500 mm T handle shaft
- 1 PC. 5 lbs / 2.2 kgs hammer
- 1 PC. Axle puller
- 1 PC. Hub puller
- 1 PC. Hook
- 1 PC. Locking pliers puller
- 1 PC. Dent puller
- 1 PC. Central bolt
- - Hex 19mm x 5/8" x 18UNF x L140mm
- 1 PC. Twin head
- 1 PC. Tripe head
- 1 PC. Adjustable nut
- 3 PC. 3.5" leg
- 3 set nut & bolt



Axle Puller With Slide Hammer

9BQ11

- 5 lbs / 2.2 kgs slide hammer
- 500 mm T handle shaft

4 1 / 4

3
PC.



CONTENTS:

- 1 PC. 500 mm T handle shaft
- 1 PC. 5 lbs / 2.2 kgs hammer
- 1 PC. Axle puller

Auto Body Repair Tool



CAUTION Please wear proper safety gear while working.



9CF110

- Bumping hammer
- Flat face

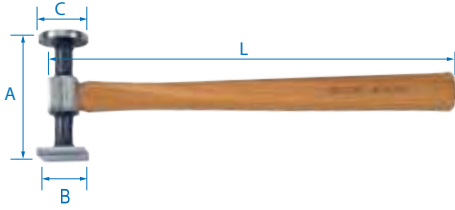

KT NO.	A mm	B mm	C mm	L mm		
9CF110	98.5	38	40	325	440	6 / 36

9CF120

- Light shrinking hammer - smooth
- Flat face + milled square face



KT NO.	A mm	B mm	C mm	L mm		
9CF120	98	40	38	325	467	6 / 36

9CF130

- Straight pick & finishing hammer



KT NO.	A mm	B mm	L mm		
9CF130	138	40	325	467	6 / 36

9CF131

- Curved pein & finishing hammer



KT NO.	A mm	B mm	L mm		
9CF131	140	40	325	467	6 / 36

9CF132

- Straight pein & finishing hammer



KT NO.	A mm	B mm	L mm		
9CF132	141	40	325	460	6 / 36

9CF210

- Utility dolly

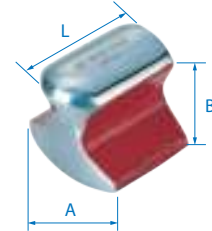

KT NO.	A mm	B mm	L mm		
9CF210	69	64	42.3	1380	6 / 12



Auto Body Repair Tool & Set



9CF220

- Curved dolly

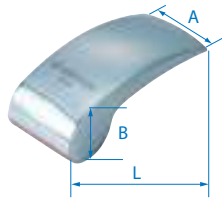

KT NO.	A mm	B mm	L mm		
9CF220	58.6	45	133	1630	6 / 12

9CF230

- Heel dolly

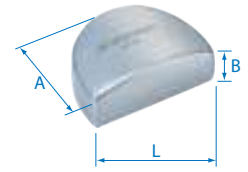

KT NO.	A mm	B mm	L mm		
9CF230	60	30	79.3	1130	6 / 12

9CF240

- Toe dolly

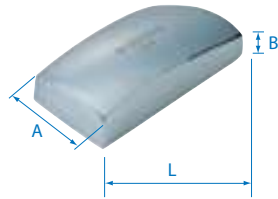

KT NO.	A mm	B mm	L mm		
9CF240	58.5	29.1	121	1400	6 / 12

9CF241

- Thin toe dolly



KT NO.	A mm	B mm	L mm		
9CF241	55	24	118	960	6 / 12

9CF-107

9CF-207

9CF-307

- All drop forged medium(SAE/AISI 1045,1055) carbon steel
- Hammers are hardened and tempered, including 3 hardwood handled hammers and 4 dollies

7
PC.



9CF-107



9CF-207



9CF-307

KT NO.	Contents			
9CF-107	9CF130	9CF240	7.50	1 / 2
9CF-207	9CF131	9CF220 9CF230	7.10	
9CF-307	9CF132	9CF241 9CF210	7.10	



Pneumatic Dent Puller

9CH212

- With 3 LB (1.36 kgs) sliding hammer
- With brass valve and 1/4" air plug
- With 13" length inlet hose
- With 2 PC. pads (120mm , 150mm)
- Air exhaust from the handle
- Working pressure 90 PSI

⚖️ 3.5 📦 1/4



Bodywork File & Set

9CM01

- Used for sheet-metal working
- Suitable for flat and curved surfaces
- Double-sides file with radial shape
- Lightweight aluminium body
- 1 PC. file included



9CM11

9CM209



KT NO.	Version	Teeth inch	Length mm	⚖️	📦
9CM01	rough	8	355	1580	1 / 20

9CM2

- Used for sheet-metal working
- Suitable for flat and curved surfaces
- Double-sides file with radial shape
- For 9CM11



KT NO.	Version	Teeth inch	Length mm	⚖️	📦
9CM209	rough	8	355	330	1 / 50
9CM212	fine	12	355	330	1 / 50

Slide Hammer Bodywork Puller Set

9CH01

- 6 lbs / 2.7 kgs slide hammer with 540 mm shaft make more powerful
- Variety attachment adaptor suitable for different situation
- Use for vehicle body panel and chassis or other metal distortion etc.

⚖️ 8.50 📦 1/2



CONTENTS:

- 1 PC. 540 mm handle shaft
- 1 PC. 6 lbs / 2.7 kgs hammer
- 1 PC. Large curve hook
- 1 PC. Small curve hook
- 1 PC. Large 90° hook
- 1 PC. Small 90° hook
- 1 PC. Flat squashed attachment
- 1 PC. Straight attachment
- 1 PC. Double attachment
- 1 PC. Tapping screw
- 1 PC. Hook attachment with chain



Putty Knife

9CJ1112

1-1/4"



KT NO.	A inch	A mm	L inch	L mm	⚖️	📦
9CJ1112	1-1/4	32	8-1/2	218	60.0	24 / 144

9CJ1120

2"



KT NO.	A inch	A mm	L inch	L mm	⚖️	📦
9CJ1120	2	50	8-1/2	218	70.0	24 / 144



Putty Knife

9CJ1130

3"



KT NO.	A		L		g	Cubes
	inch	mm	inch	mm		
9CJ1130	3	76	8-1/2	218	82	24 / 144

Bolstered Scraper

9CJ2120

2"



KT NO.	A		L		g	Cubes
	inch	mm	inch	mm		
9CJ2120	2	50	8-1/2	218	140	24 / 144

Stainless Steel Putty Knife Set

9CJ013



3
PC.

Contents

g 0.20 Cubes 1 / 24



9CJ1112



9CJ1120



9CJ1130

Stainless Steel Bolstered Scraper Set

9CJ023



3
PC.

Contents

g 0.40 Cubes 1 / 24



9CJ2112



9CJ2212



9CJ2120

Bolstered Scraper

9CJ2112

1-1/4"



KT NO.	A		L		g	Cubes
	inch	mm	inch	mm		
9CJ2112	1-1/4	32	8-1/2	218	120	24 / 144

9CJ2212

1-1/4"



KT NO.	A		L		g	Cubes
	inch	mm	inch	mm		
9CJ2212	1-1/4	32	8-1/2	218	120	24 / 144

Pinch Weld Scraper

9CJ3104

1/2"



KT NO.	A		L		g	Cubes
	inch	mm	inch	mm		
9CJ3104	1/2	12	6-1/2	168	75	24 / 144

9CJ3105

5/8"



KT NO.	A		L		g	Cubes
	inch	mm	inch	mm		
9CJ3105	5/8	15	8-1/2	218	108	24 / 144

Pinch Weld Scraper

9CJ3106

3/4"



KT NO.	inch	mm	inch	mm	kg	ctn / pc
9CJ3106	3/4	19	6-1/2	168	75	24 / 144

Multi Purpose Single Edge Razor Scraper

9CJ61-40

- Ideal for scraping labels and decals
- Comfortable TPR handle for maximum grip
- Accepts all standard single edge razor blades



KT NO.	inch	mm	inch	mm	kg	ctn / pc
9CJ61-40	1-1/2	40	9	235	145	6 / 72

Stainless Steel Pinch Weld Scraper Set

9CJ033



3 PC.

Contents

kg 0.26 ctn / pc 1 / 24



9CJ3104



9CJ3105



9CJ3106

Mini Panel Removal Set

9CI016

- Easy to remove small trim items and panels with slim profile
- Made from impact resistant high quality nylon
- Applicable: Air vents, door panels, door locks, dash trim, internal fittings, etc.

kg 0.30 ctn / pc 12 / 48

6 PC.



Long Nose Clamp

9CD14

- Drop forged chrome molybdenum alloy steel for maximum strength
- Jaw width : 32mm
- 3 Ton straight pulling capacity

kg 1.83 ctn / pc 1 / 10

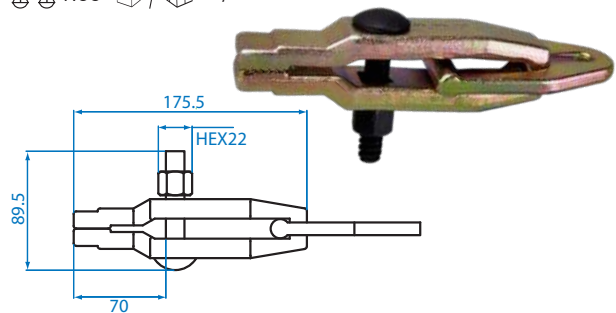

Large Pull Clamp With Top Pull

9CD21

- Drop forged chrome molybdenum alloy steel for maximum strength
- Jaw width : 37mm
- Two-way pull operation
- Dual self-tightening serrated jaws for a positive grip
- Capacity : 3 ton (straight way), 2 ton (cross way)

kg 2.45 ctn / pc 1 / 6

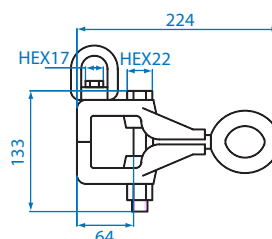

Small Pull Clamp With Top Pull

9CD31

- Drop forged chrome molybdenum alloy steel for maximum strength
- Jaw width : 44mm
- 44mm wide mouth with teeth
- With top pull and 360 degree self tightening pull ring
- Dual self-tightening serrated jaws for a positive grip
- Ideal for work in tight areas
- Capacity : 5 ton (straight way), 2 ton (cross way)

KT NO. 2.38  1 / 6

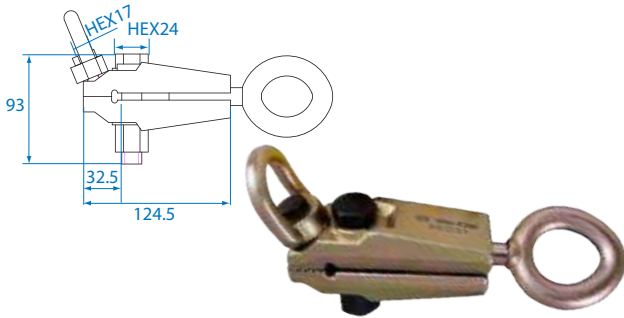

Double Suction Pad Holder

9CW21

- Lifting up to 65 kg in horizontal position
- Adjustable handle designed for curved surface
- Ø120mm rubber vacuum cup can prevent from the damage of surface and grip tightly
- Use for holding glass, tiles, sheet metal, etc.



Windscreen Remove Tool Set

9CW01



- Use for removing glued of vehicle windows
- Use A with C to pierce the wire through the adhesive beads
- Use the cutting wire with B to remove adhesive beads



CONTENTS :

- A - Wire feeder tool
- B - Wire pull handle - pair
- C - Triangle cutting wire - 22 meters



KT NO.	Wire L m	T Handle L mm		
9CW01	22	330	456	8 / 32

Single Suction Pad Holder

9CW22

- Lifting up to 40 kg in horizontal position
- Ø120mm rubber vacuum cup can prevent from the damage of surface and grip tightly
- Use for holding glass, tiles, sheet metal...



Alternator Tool & Set

- Specialized in removing & installing freewheel pulleys on alternator
- Ideal for dismantling and assembling the free wheel pulley while changing the alternator or pulley
- The pulley shaft is held in place with the bit on 1/2" DR. socket whilst the nut is undone using the 33 teeth union nut with 19mm spanner
- Suitable generator brand: Bosch, Valeo, Magetic Marelli, Denso, etc.
- It's also interchangeable and comprehensive components to work on VW, Audi, Citroen/ Peugeot, Mercedes, Renault, BMW, Fiat, Ford, Toyota, etc.

9DA103

1/2"

- M10 spline



KT NO.	Size	Overall length mm		
9DA103	M10	113	151	10 / 120

9DA104

1/2"

- T50 Star



KT NO.	Size	Overall length mm		
9DA104	T50	113	151	10 / 120

Alternator Tool & Set

9DA022

- Specialized in removing & installing freewheel pulleys on alternator
- Suitable generator brand : Bosch, Valeo, Magetic Marelli, Denso, etc.
- It's also interchangeable and comprehensive components to work on VW, Audi, Citroen/Peugeot, Mercedes, Renault, BMW, Fiat, Ford, Toyota, etc.

CONTENTS:

- 3 PC. Combined bit socket – 3/8" DR. x M10 x 90mmL / 1/2" DR. x T50 x 113mmL / 1/2" DR. x M10 x 113mmL
- 1 PC. Spline bit socket 1/2" DR. x M10 x 110mmL
- 3 PC. 33 teeth socket – 15mm HEX x19mm / 15mm Hex x17.5mm / 22mm Hex
- 2 PC. Hex nut – 22mm x 30mmL (Ø12.0mm) / 17mm x 35mmL (Ø14.7mm)
- 1 PC. - 35mm Round x 17mm hex (four pin)
- 1 PC. - 38mm Hex adaptor (three pin)
- 1 PC. - 28.6mm Round x H28 x H22 x 32mmL
- 2 PC. - Hexagon head nut – 28H x H19 x 35mmL / 28H x H21 x 36mmL
- 1 PC. - M10 x H12 bit 64mmL
- 6 PC. - 10mm shank head bits 75mmL – T40 / T50 / M8 / M10 / H8 / H10
- 1 PC. - 1/2" DR. Bit holder

2.57 1 / 5

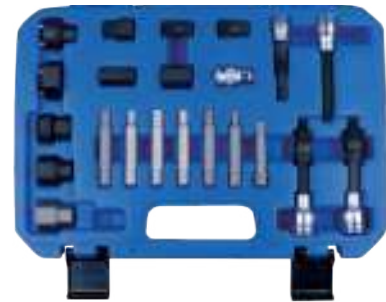

22 PC.



Spark Plug Boot Pliers

9DB201

- Remove spark plug cables safely and prevent cable damage
- Pliers' handles and jaws are coated with a heavy-duty plastic for sure grip

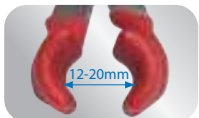
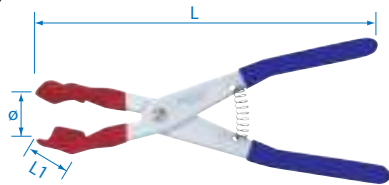

KT NO.	L mm	Ø mm	L1 mm		
9DB201	260	12~20	20	289	6 / 36

Automotive Voltage Tester

9DC23

- Insulated alligator clip with 150 cm cable
- 2 LEDs indicate positive(+)/negative(-) polarity
- Test voltage 3~48V
- For application of D.C. circuits only
- Two testing methods as illustration

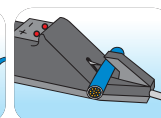
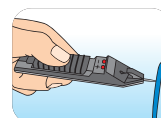
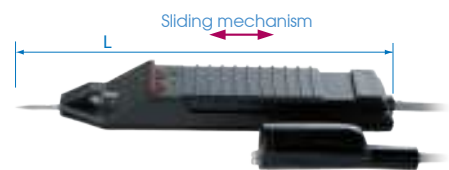

KT NO.	L mm	Test range		
9DC23	150	3~48V	52	10 / 100



Circuit Tester

9DC22

- Bronze body housing
- Cover cap for contact needle
- Bulb of 24V/3W interchangeable
- For 6/12/24V DC systems
- For application of D.C. circuits only

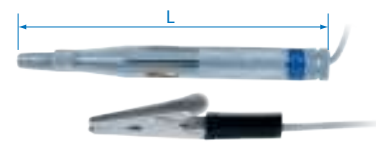
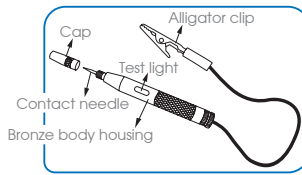

KT NO.	L mm	Test range		
9DC22	107	6~24V	50	20 / 200

Digital Display Circuit Tester

9DC242

- For 6/12/24V DC systems
- For application of DC circuits only
- Check if the circuit is electrified or not by stainless steel stylus
- Bigger heavy duty insulated alligator ground clip
- 3M long retractable cable
- LCD display easy to read digital voltage display
- Powered from the power source being measured, no batteries required
- CE approval EN 61000-6-3(2007) , EN 61000-6-1(2007)
- Do not use on air bags
- Ultra-V will burn circuit board



Positive (+) polarity



Negative (-) polarity

Specification	
Measured voltage	5~28V
Testing current	<10mA
Operating temp	-10~50° C
Operating humidity	<80%

KT NO.	Test range		
9DC242	6, 12, 24	225	10 / 60

Circuit Tester with Nixie Display

9DC243

- For 12/24/48V DC systems
- For application of DC circuits only
- Check if the circuit is electrified or not by stainless steel stylus
- Test by car battery or negative ground conversion
- 3M long retractable cable
- 1M extension cable
- Powered from the power source being measured, no batteries required
- Nixie display easy to read digital voltage display
- CE approval EN 61000-6-3(2007) , EN 61000-6-1(2007)
- Do not use on air bags
- Ultra-V will burn circuit board



Positive (+) polarity



Negative (-) polarity

Specification	
Measured voltage	0.3~60V
Testing current	<10mA
Operating temp	0~50° C
Operating humidity	≤ 80%

KT NO.	Test range		
9DC243	12, 24, 48	277	10 / 60



Battery Tester

9DD21

- Test battery hydrometer quickly
- Use to check battery condition and charge state
- Detects hot or cold overcharge accurately
- For 6 / 12 / 24 volt system

⚖️ 85 📦/📦 10 / 100



Anti-freeze & Coolant Tester

9DD22

- Use to check condition of antifreeze and coolant (Ethylene Glycol)
- Ideal for avoiding winter freeze-ups and summer overheating

⚖️ 85 📦/📦 10 / 100



Mechanic's Stethoscope

9DH11

- Ears covered with plastic, effective to separate from outside noise
- 210mm extension probe can expand the space while operating or using in narrow space
- Quickly to find and detect the abnormal noise with the probe
- Use for detecting various vehicles parts or machine equipment

⚖️ 147 📦/📦 12 / 72



Vehicle Battery Tester

9DC51

- Test a 12V lead-acid battery of any vehicle
- CCA testing(SAE/DIN/EN/IEC/CA standard)
 - Working voltage: DC 9~15V
- Engine starting voltage test
 - Measures the minimum voltage when the engine starts
- Charging voltage test
 - About 14 volts
- CCA Level bar indication
 - LOW / MID / HIGH
- LCD with background light

KT NO.	Test range(V)	Size(mm) L x W x H	⚖️	📦/📦
9DC51	9 ~ 15	135 x 78 x 33	374	1 / 30



CE

Digital Glow Plug Tester

9DM1A1

- Suitable for steel and ceramic glow plugs
- LCD Display
- Short circuit protection & reverse charging protection
- Auto power off : 110 seconds
- 9V batteryx1 (included)
- CE approval

KT NO.	Glow plug(V)	Size(mm) L x W x H	⚖️	📦/📦
9DM1A1	3.5-4.4-5-7-8.5 10-11-24	135 x 78 x 33	356	1 / 40



CE



Gasoline Engine Injection Pressure Tester Kit

9DP1101

- Used to identify and diagnose low fuel pressure
- Shockproof gauge with dual reading of 0~120 PSI and 0~8 bar
- Various kit of adapters for most injection systems of European, Japanese and American vehicles, includes Bosch CIS, GM TBI and MFI system



81
PC.

5.0 1 / 4

No.	Description	No.	Description
1	1 PC. (0-120 psi/0-8bar)	20	1 PC. Adapter (M14 male-female)
2	1 PC. Connector Hose	21	1 PC. Adapter (M10 male-M12 male)
3	1 PC. Connector Hose	22	1 PC. Adapter (M10 female-M12 male)
4	1 PC. Connector Hose	23	1 PC. Adapter (M8 female-M12 male)
5	1 PC. Connector Hose	24	2 PC. Adapter (M8 male-M12 male)
6	1 PC. Connector Hose	25	1 PC. Adapter (M14 male-M12 male)
7	1 PC. Connector Hose	26	1 PC. Adapter (M16 male-M12 male)
8	1 PC. Connector Hose	27	1 PC. Adapter (Banjo bolt M12)
9	2 PC. Connector Tube (5/8"-18 male nut)	28	1 PC. Adapter (Banjo bolt M12)
10	2 PC. Connector Tube (5/8"-18 invert flare nut)	29	1 PC. Adapter (Banjo bolt M10)
11	2 PC. Adapter (M16 female~5/8")	30	1 PC. Adapter (Banjo bolt M8)
12	2 PC. Adapter (M14 female~3/8")	31	1 PC. Adapter (Banjo bolt M6)
13	2 PC. Adapter (M16 female~3/8")	32	1 PC. Adapter
14	2 PC. Adapter (M14 female~3/8")	33	1 PC. Adapter (M8 male-M12 male)
15	2 PC. Adapter (M16 ar-10mm)	34	1 PC. Adapter (M16 female-M12 male)
16	1 PC. Adapter	35	1 PC. Adapter (M14 female-M12 male)
17	1 PC. Manifold Adapter	36	1 PC. Gauge Hook
18	1 PC. Manifold Adapter	37	1 PC. Repair Pack
19	1 PC. Adapter (90 degrees)		

Gasoline Compression Tester Kit

9DP130

- Suitable for petrol engines on lawn mowers, motorbikes, cars, trucks and so on.
- Quickly diagnose problems with pistons, rings, and valves
- Gauge has dual color scale with 0-300 PSI, 0-20 Kpa
- Easy pressure release button on side of tester
- Brass corrosion resistant fittings

8
PC.

3
PC.



9DP1301



9DP1302

KT NO.	Max Pressure	1206	1100
9DP1301	300PSI / 20Kpa	1206	1 / 10
9DP1302	300PSI / 20Kpa	1100	1 / 10

Diesel Engine Compression Tester Kit

9DP2301

- Suitable for testing cars and light commercial vehicles with direct or indirect injection on diesel engine
- Gauge reading range from 0-1000 PSI (0-70 bar)
- Includes a pressure gauge, various connect adapter and replacement seal & washer



11
PC.

2.58 1 / 6

No.	Description	No.	Description
A	1 PC. 2-1/2" gauge with 420mm hose	H	1 PC. Glow plug adapter (114mm*M10*1.25)
B	1 PC. Glow plug adapter (73.5mm*M10*1.25)	I	1 PC. Glow plug adapter (119mm*M10*1.0)
C	1 PC. Glow plug adapter (54mm*M12*1.25)	J	1 PC. Dummy injector (75mm*M20*1.5)
D	1 PC. Glow plug adapter (72mm*M14*1.25)	K	1 Set Seal & washer
E	1 PC. Dummy injector (114mm)	L	1 PC. 90° Elbow
F	1 PC. Dummy injector (64mm*M24*2.0)	M	1 PC. Clamp plate
G	1 PC. Stanadyne dummy (112mm)		



Oil Pressure Tester Kit

9DP3201

- Suitable for testing engine oil pressure and transmission pressure
- Applicable to both gasoline and diesel engines, also suitable for passenger cars and light trucks
- Gauge reading range from 0-150 PSI (0-10 bar)
- Provided with an oil filter clamp for piercing through oil filter canister when oil pressure switch is hard to access

2.10 1 / 5

Adapter

Black (Imperial threads)	Silver (Metric threads)
1/2" x 20 UNF	M10 x P1.0
3/8" x 20 UNF	M12 x P1.5
1/4" x 18 NPTF	M14 x P1.5
1/8" x 27 UPT	M16 x P1.5
R 1/8" DIN	M18 x P1.5



13
PC.



Universal Terminal Release Tool Set

9DT11

- Suitable for most of the vehicles, VW Group, BMW, Opel, Renault, Ford, Daimlerchrysler, Fiat, Toyota and Saab
- Use to loose contacts easily or carry out other applications in the field of car electricity

A	9DT11-1	ABS 4.0mm round terminal
B	9DT11-2	3.5mm round terminal
C	9DT11-3	1.5mm round terminal
D	9DT11-4	Maxi power timer
E	9DT11-5	Pit pod / Faston 6.3mm
F	9DT11-6	JPT / SPT
G	9DT11-7	Micro timer ii
H	9DT11-8	Standard tool
I	9DT11-9	Standard 2.72mm
J	9DT11-10	Standard 1.48mm
K	9DT11-11	Standard 1.89mm
L	9DT11-12	Micro standard

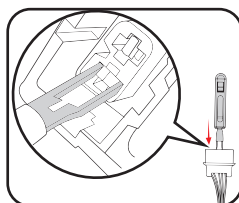
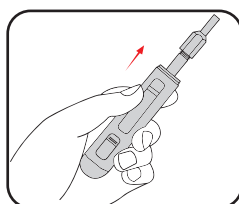

12
PC.

850 1 / 10

Safety Goggles

9CK-101

- Soft PVC frame & lens high impact clear polycarbonate
- Anti-dust and anti-impact vents

KT NO.	L1 inch	L1 mm	L2 inch	L2 mm	Weight	Quantity
9CK-101	2-7/8	74	6	153	70	20 / 200



Steel Wire Brush

9CZ101

- Material : wood handle / steel wire
- Wire brush with three rows

KT NO.	H mm	L1 mm	L2 mm	Weight	Quantity
9CZ101	22	258	105	65	24 / 144

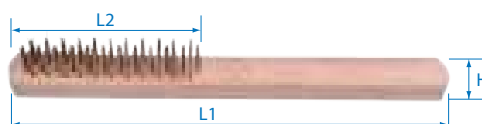

Pressure Oil Can

9TB225

9TB500

- Material: Plastic body (9TB225)
- Material: Metal body (9TB500)



KT NO.	Capacity c.c.	9TB225	9TB500
9TB225	225	103	1 / 160
9TB500	500	302	10 / 60

Clip Removal Pliers

9TC101

- For removal of door inner-linings and other trim items held in place by plastic rivets



KT NO.	inch	mm	g	boxes
9TC101	9	230	241	12 / 48

Flexible A/C Detective Light

9TQ31

KT NO.	L1 mm	L2 mm	L3 mm	g	boxes
9TQ31	34	400	140	107	1 / 5



Refillable Pressure Sprayer

9TBA600

- Suitable for lubrication, cleaning brake systems, removing dust and applying anti-rust
- Two-position folding nozzle for a standard or long stream spray pattern for narrow and difficult to reach areas
- Do not use with strong chemical or corrosive fluid
- The aluminum alloy material uses a one-piece seamless structure to withstand high pressure
- Increase in thickness makes the product less prone to deformation and stronger
- The trigger is not affected by recoil force and is easy to operate
- Max pressure 350 Psi (25Kg /cm²)
- Safety valve pressure : 140Psi (9.84 Kg /cm²)



CAUTION Always wear eye protection while using this tool

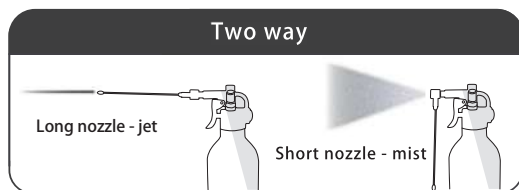

KT NO.	inch	L mm	capacity	g	boxes
9TBA600	11	280	600 c.c.	330	1 / 12

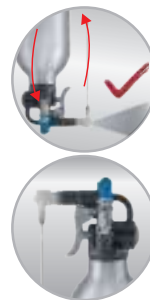

Safety pressure valve

Air inlet valve

L

9TBA650

- Suitable for lubrication, cleaning brake systems, removing dust and being anti-rust
- Two-position folding nozzle for a standard or long stream spray pattern for narrow and areas which are difficult to reach
- Aluminum canister
- Do not use with strong chemical or corrosive fluid

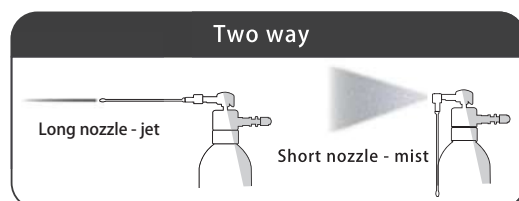

KT NO.	inch	L mm	capacity	g	boxes
9TBA650	11	287	650 cc	290	1 / 12

spare nozzle #9TBA650BTK



Safety pressure valve

Air inlet valve

L

Pry Bar & Set

- Grip material - PP+TPR
- Chrome vanadium alloy steel

9TK1

- Packaged in plastic tray
- Pry bars are for prying and levering
- Sturdy blade minimizing lever spring effect
- It's hardened and tempered for maximum durability



KT NO.	L mm		
9TK108	204	110	6 / 72
9TK112	312	286	6 / 48
9TK118	458	514	6 / 48
9TK124	608	655	6 / 36

9TK014



4 PC.

Contents 1.87 5 / 10

9TK108, 9TK112, 9TK118, 9TK124

Jumbo Pry Bar & Set

9TK2

- For heavy-duty application
- Includes straight, 90, 45, 30 degree tip for variety situation to use
- Extra long pry bar makes more powerful for prying and levering

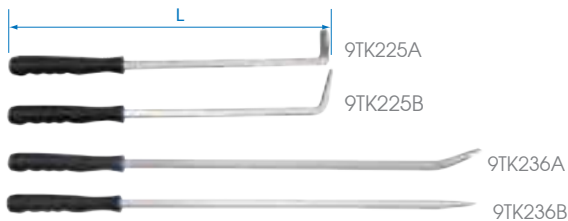

KT NO.	inch	L mm	Type		
9TK225A	25	625	90°	1620	1 / 6
9TK225B	25	625	45°	1510	1 / 6
9TK236A	36	920	30°	2070	1 / 12
9TK236B	36	920	Straight	2060	1 / 12

9TK024



4 PC.

Contents 9.34 1 / 2

9TK225A
 9TK225B
 9TK236A
 9TK236B

Rolling Head Pry Bar & Set

- Material - chrome vanadium alloy steel
- Finishing - Black phosphate with polished head



9TK3

- With a long tapered end for alignments and a rolling head for prying

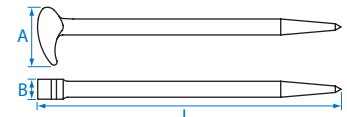

KT NO.	inch	L mm	A mm	B mm		
9TK306	6	151	29.0	10.0	75	10 / 200
9TK312	12	305	36.5	12.3	252	2 / 40
9TK316	16	405	45.6	14.5	501	2 / 20
9TK320	20	504	60.2	18.0	952	2 / 20

9TK034



4 PC.

Contents 1.73 1 / 8

9TK306
 9TK312
 9TK316
 9TK320

Door Upholstery Remover

- Grip material - PP+TPR
- Chrome vanadium alloy steel

48280180

43280212

- Special tool to remove the lining and clip of the car

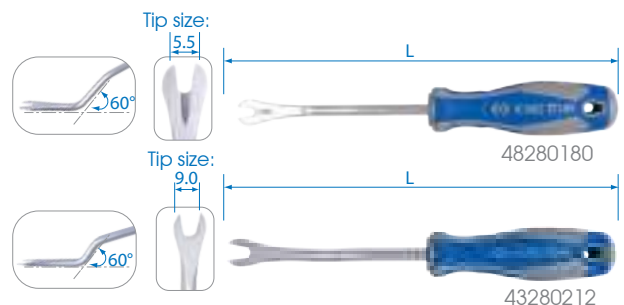

KT NO.	Tip mm	L mm	Type		
48280180	5.5	210	60°	90	12 / 144
43280212	9	240	60°	134	12 / 144



Hook & Pick Set

43250115Y

- 10" Bent-pick

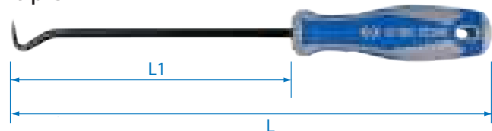

KT NO.	L mm	L1 mm		
43250115Y	260	150	94	12 / 144

43260115Y

- 10" Hook-pick

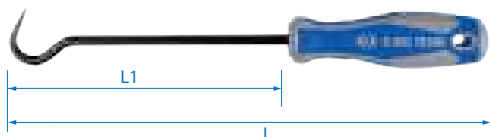

KT NO.	L mm	L1 mm		
43260115Y	260	150	96	12 / 144

43270115Y

- 10" 90°-pick

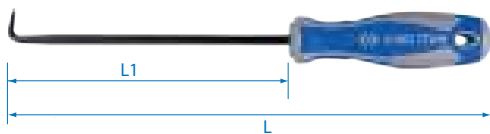

KT NO.	L mm	L1 mm		
43270115Y	260	150	94	12 / 144

43290115Y

- 10" Straight-pick

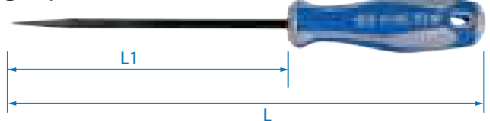

KT NO.	L mm	L1 mm		
43290115Y	260	150	91	12 / 144

30914AY

- Use for scribing, alignment, installing and removing O rings, seals, cotter pins and washers

Contents

62.8 6 / 72

43350175Y	43360175Y
43370175Y	43390175Y

9-30904AY

- Use for scribing, alignment, installing and removing O rings, seals, cotter pins and washers



4 PC.



Contents

0.43 1 / 10

43250115Y	43270115Y
43260115Y	43290115Y

43240115Y

- Wide scraper
- Use for removing old gaskets more easily and quickly



KT NO.	L mm	L1 mm		
43240115Y	260	150	149	12 / 144

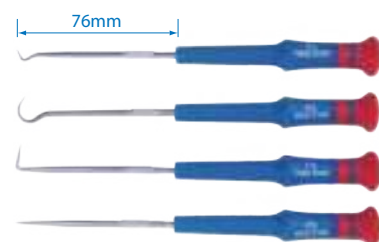

4 PC.



Hook & Pick Set

9-30909AY

Tray category #8 (375 x 187mm)

- Use for scribing, alignment, installing and removing O rings, seals, cotter pins and washers
- Use for removing old gaskets more easily and quickly

9 PC.

Contents		0.69	1 / 12
	43250115Y		43350175Y
	43260115Y		43360175Y
	43270115Y		43370175Y
	43290115Y		43390175Y
	43240115Y		



Radiator Hose Removal Tools

- Grip material - PP+TPR
- Chrome vanadium alloy steel

432A0113

- 9-1/2" Lightning type removal tools
- 9-1/2" U type removal tools

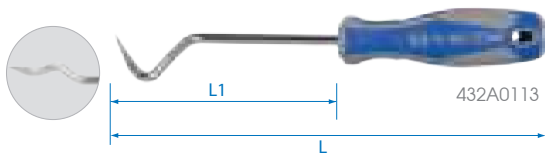

KT NO.	L mm	L1 mm	0.93	12 / 96
432A0113	240	130	93	12 / 96

432A0213

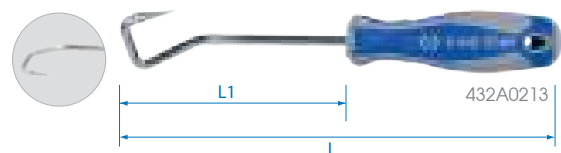

KT NO.	L mm	L1 mm	1.01	12 / 96
432A0213	240	130	101	12 / 96

Magnetic Flexible Handle

- Grip material - PP+TPR

2121

- Enhanced flexible conduit for perfect shaping
- More powerful magnetic force

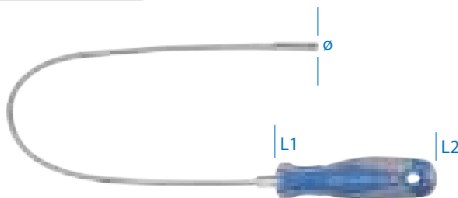

KT NO.	Size	Dia x length(mm) L1 L2	Magnetic power(kg)	1.00	1 / 100
2121-12	12"	Ø 7 x 305 415	0.5	100	1 / 100
2121-18	18"	Ø 7 x 457 567	0.5	120	1 / 80

2121A

- Powerful magnet retrieves metal objects up to 3kg
- Slide cap prevents retrieving foreign objects
- Enhanced flexible conduit for perfect shaping
- Grip Material-PP+TPR
- Chrome vanadium alloy steel

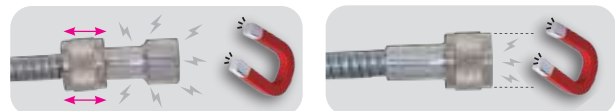
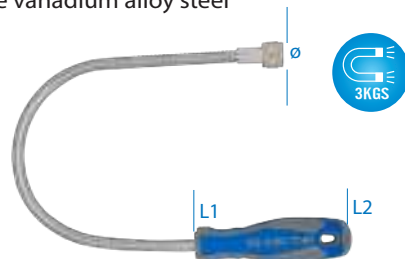

KT NO.	Size	Dia x length(mm) L1 L2	Magnetic power(kg)	2.50	1 / 25
2121A-15	15"	Ø 18 x 381 491	3	250	1 / 25
2121A-18	18"	Ø 18 x 457 567	3	270	1 / 25



Magnetic Pick-Up Tool

2124

- Compact and ergonomic design for comfortable holding
- Enhanced flexible conduit for perfect shaping
- Solid crimping for holding tube and flexible conduit
- More powerful magnetic force
- Comfortable pushing strength

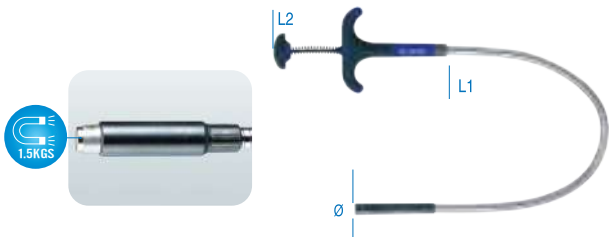

KT NO.	Size	Dia x length(mm) L1	L2	Magnetic power(kg)	⚖️	📦	📦
2124-18	18"	∅13.5 x 450	610	1.5	181	1	36

Magnetic Claw Pick-Up Tool

2126A-18

- Compact and ergonomic design for comfortable holding
- Enhanced flexible conduit for perfect shaping
- Solid crimping for holding tube and flexible conduit
- Maximum claw width 1-1/4"
- Comfortable pushing strength

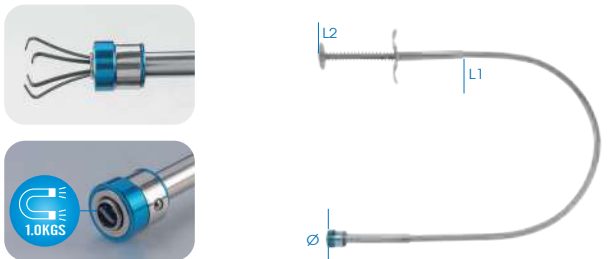

KT NO.	Size	Dia x length(mm) L1	L2	🔗	⚖️	📦	📦
2126A-18	18"	∅15 x 440	600	1-1/4"	258	1	36

3 in 1 Pick-Up Tool

2129-24

- Compact and ergonomic design for comfortable holding
- Enhanced flexible conduit for perfect shaping
- Solid crimping for holding tube and flexible conduit
- More powerful magnetic force
- Hook type claw
- Clamp light
- Comfortable pushing strength
- Lithium cell : LR521 x 3

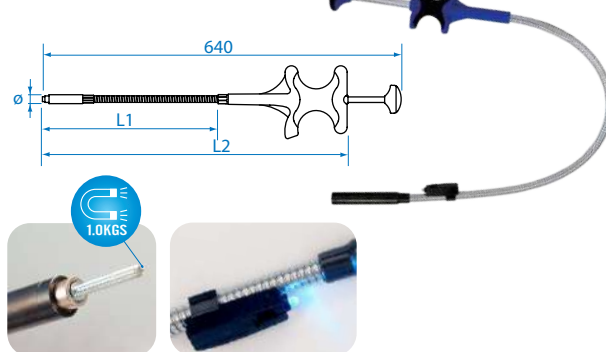

KT NO.	Size	Dia x length(mm) L1	L2	Magnetic power(kg)	🔗	⚖️	📦	📦
2129-24	24"	∅13 x 470	570	0.4	1-1/4"	280	12	48

Telescoping Magnetic Pick-Up Bar

2128-26

- Pen style for carrying conveniently



KT NO.	Extendable Length mm	Magnetic Power	⚖️	📦	📦
2128-26	130~640	3.5LBS/1.6KGS	45.6	50	200

Multi-Function Telescoping Bar

9TQ21

⚖️ 87 📦 50 / 100

- ▶ Magnetic Pick-Up Bar
- ▶ 38 mm Diameter Inspection Mirror
- ▶ Scriber



- Magnetic power : 1.3 lbs / 0.6 kgs
- Extendable length : 635 mm
- To inspect hidden or narrow areas
- Double ball joint links swivel mirror for viewing to 360°
- To mark lines on workpieces
- To clean the water-sprouting hole of the windscreen wiper

3 in 1 Flexible Inspection Bar

9TQ02

203 12 / 72

► Magnetic Pick-Up Bar



- Magnetic power : 3.5 lbs / 1.6 kgs
- Length : 450 mm

► Blub



- Size:2.2 V , 0.25 A
- Operates On 2 AA Batteries
- (Not Included)

► Inspection Mirror



- 50 x 25 mm playground shape
- To inspect hidden or narrow areas
- Double ball joint links swivel mirror



Videoscope

- 5.5mm lens with 6 LED, can be used for shooting video or taking photo (1080P HD Camera 1920 x 1080 resolution)
- The videoscope is suitable for visually inspecting areas that are difficult to access over a great distance
- CE / ROSH / FCC certification
- IP67 waterproof rating

9TQ11

- Handheld version
- 4.3 inch LCD display with 1080P resolution
- Equipped with 2600mAh Li-ion battery, can be continuous use for 3 hours
- UN38.8 certification

740 1 / 8

Contents

	Protective cap
	Hook
	Magnet
	Side mirror
	Charging cable



9TQ12

- Wifi version
- Before use, download the inskam APP, both IOS & Android are applicable
- Equipped with 1800mAh Li-ion battery, can be continuous use for 2-3 hours

331 1 / 45



Contents

	Protective cap
	Hook
	Magnet
	Side mirror
	Charging cable











10-1/2" Internal-External Heavy Duty Circlip Pliers Set

45115PP

- Internal & External circlip pliers 10-1/2" 265 mmL, maximum spread 45 mm
- Interchangeable tips 0°, 15°, 45°, 90°
- Internal ring 65~140 mm, External ring 65~120 mm
- Interchangeable tips 2.75 mm and 3.00 mm
- Heavy duty pliers with ratcheting locking device large rings are easily controlled

Contents

	1 PC. Internal straight circlip pliers
68GS-11	
	1 PC. External straight circlip pliers
68RS-11	
	1 Set. 15° Internal interchangeable (Ø3mm, Black)
68GR-01	
	1 Set. 45° Internal interchangeable (Ø3mm, Black)
68GQ-01	
	1 Set. 90° Internal interchangeable (Ø3mm, Black)
68GB-01	
	1 Set. 15° External interchangeable (Ø2.75mm, Silver)
68RR-01	
	1 Set. 45° External interchangeable (Ø2.75mm, Silver)
68RQ-01	
	1 Set. 90° External interchangeable (Ø2.75mm, Silver)
68RB-01	
	1 Set - Screws (6 PC. M5x0.8)
68ZZ-01	

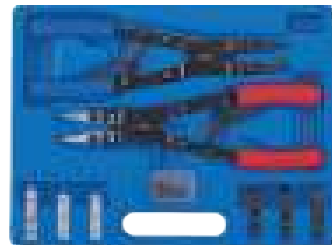
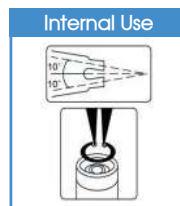
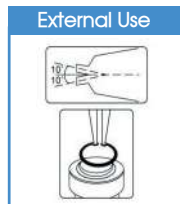

15 PC.





KT NO.	L		Spread		Ømm	Ømm	kg	/	/
	inch	mm	inch	mm					
45115PP	10-1/2	267	2	50	-	-	1.30	1	10
68GS-11	10-1/2	267	2	50	65~140	3	0.31	25	50
68RS-11	10-1/2	267	2	50	65~120	2.75	0.32	25	50

16" Internal-External Heavy Duty Circlip Pliers Set

45211PP

- Internal & External circlip pliers 16" 400 mmL, maximum spread 85 mm
- Interchangeable tips 0°, 45°, 90°
- Internal ring 78-155 mm, External ring 88~165 mm
- Interchangeable tips 3.00 mm
- Heavy duty pliers with ratcheting locking device large rings are easily controlled

Contents

	1 PC. Internal straight circlip pliers
68GS-16	
	1 PC. External straight circlip pliers
68RS-16	
	2 Set. 45° Internal interchangeable
68GQ-02	
	2 Set. 90° Internal interchangeable
68GB-02	
	1 Set - Screws (6 PC. M6x1.0)
68ZZ-02	

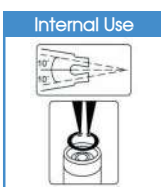
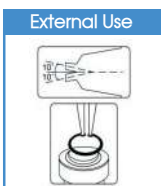

11 PC.

KT NO.	L		Spread		Ømm	Ømm	kg	/	/
	inch	mm	inch	mm					
45211PP	16	406	3-1/4	85	-	-	3.32	1	6
68GS-16	16	406	3-1/4	85	78~155	3	0.93	1	25
68RS-16	16	406	3-1/4	85	88~165	3	0.97	1	25



Kneeling Mat

9TG11

- Kneeling mat makes working more comfortable during repairing wheels, brakes and exhausts
- Make the chemicals and oil resistant
- Easily clean surface
- Light and small, easy to carry and available to hang it

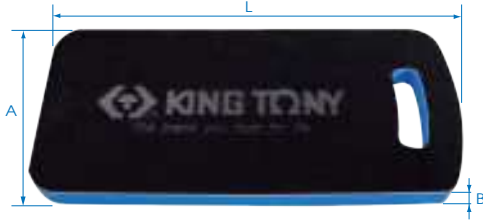

KT NO.	L mm	A mm	B mm		
9TG11	455	214	30	126	1 / 18

LED Folding Mat

9TG21

- Folding mechanics mat for mechanics sit / kneel and lie on it
- 24 SMD LED lights
- Brightness : 600 Lumen(lm)
- 3 x AA batteries not included
- Folds for easy storage
- Make the chemicals and oil resistant

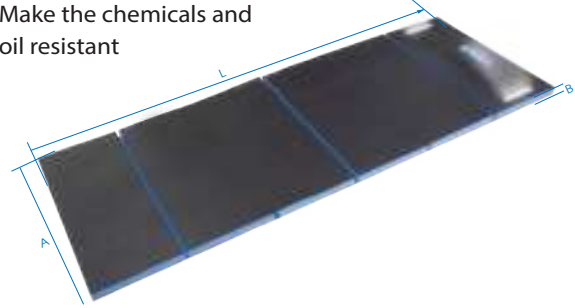

KT NO.	L mm	A mm	B mm		
9TG21	1150	420	24	992	1 / 10

LED Kneeling Mat

9TG12

- Kneeling mat with work lights for under car repair or useful as a head protector
- 24 SMD LED lights
- Brightness : 600 Lumen(lm)
- 3 x AA batteries not included
- Make the chemicals and oil resistant

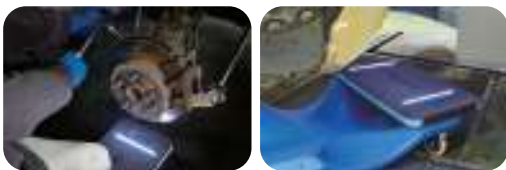

KT NO.	L mm	A mm	B mm		
9TG12	460	270	30	320	1 / 25

Plastic Car Creeper

87C23-B

- Designed for 2 side storage trays, for easily picking up for small parts or tools
- Vinyl-covered foam pad brings more comfortable while working
- 280 lb. weight capacity
- 1-1/4" ground clearance



KT NO.	Size mm		
87C23-B	1010 x 475 x 130 (40")	5000	1



Steel Creeper

87C24-B

87C25-B

- Designed with comfortable sponge cushion
- 300 lbs capacity
- 6 PC. durable swivel casters
- Long size Vinyl-covered foam pad brings more comfortable while working
- All steel construction frame makes it more strong and durable



KT NO.	Size mm		
87C24-B	920 x 425 x 95 (36")	5600	1
87C25-B	1020 x 425 x 110 (40")	7400	1

Wing Protector

9TP11

- Protection from unwanted scratches, dents and dirt
- Magnetic attachment keeps paintwork safe from damage
- Rugged, padded imitation leather and reinforced edges provide a perfect, cushioned working area



KT NO.	Size mm		
9TP11	1050 x 650	649	1 / 8

Wing Protector

9TP12

- Protection from unwanted scratches, dents and dirt
- Magnetic attachment keeps paintwork safe from damage
- Rugged, padded imitation leather and reinforced edges provide a perfect, cushioned working area



KT NO.	Size mm		
9TP12	1050 x 650	649	1 / 8

9TP22

- Protection from unwanted scratches, dents and dirt
- Magnetic attachment keeps paintwork safe from damage
- Suction cup attachment keeps paintwork safe from damage
- Rugged, padded imitation leather and reinforced edges provide a perfect, cushioned working area
- 3 suction cups attached



- Suction cup can be strongly adsorbed on the aluminum alloy material

KT NO.	Size mm		
9TP22	1050 x 650	650	1 / 8



Oil Drain Pan

9TT11-18

- This 18 litre Oil Drain Pan includes easy grip, large carrying handles and integral spout for pouring waste oil or fluids into a recycling container. The anti-splash lip prevents spillage. Ideal for draining antifreeze or oil. (Not suitable for spray gun cleaner)



CONTENTS :

- 18 litre capacity
- Anti-splash lip
- Integral spout
- Ideal for draining antifreeze or oil
- Meets PAHS regulations



KT NO.	L mm	W mm	H mm		
9TT11-18	681	570	130	920	15

Wheel Axle Oil Drain

9TT21-03

- When the professional technician reaches for an oil drainer pan it has to be light yet strong, a convenient size for the task in hand and easily cleaned
- The wheel Axle Oil Drain is designed for HGVs, features a 3 litre capacity and is fits snugly into the dish of the wheel to catch the waste oil as it is drained from the axle. It is also stable on the workshop floor and easy to handle



CONTENTS :

- Wheel axle oil drain pan with pouring lip
- Manufactured from PE plastic
- 3 litre capacity

KT NO.	L mm	W mm	H mm		
9TT21-03	316	246	156	390	20

Drum Drain Basin

9TT31-20

- Plastic basin installed on drum for receiving waste oil
- Intended to be installed at a standard barrel, the drain lid marries with the barrel inlet allowing simple and efficient draining of waste oil from filters etc
- Features ribbed drainage channels and a filter gate to catch foreign objects



KT NO.	Ø mm	H mm		
9TT31-20	600	155	1700	5

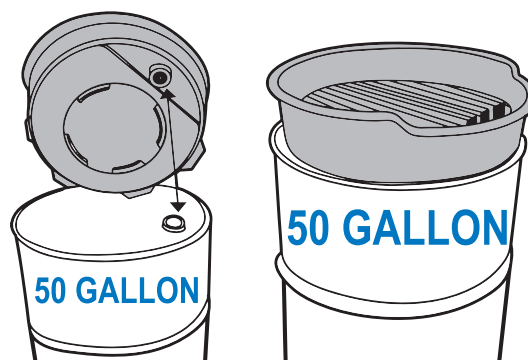

10L Pneumatic Oil(ATF) & Liquid Dispenser

9TV13

- Use to extract, transfer and dispense fluid quickly, safety and cleanly
- Non-spark, one man in same step can operate
- Provide with the safety valve, pre-setting 43 PSI (3 Bar), the exceed pressure will be relief automatically
- Provide with the pressure gauge, can be read & control the pressure in the tank more easily
- Provide 2 way control valve for dispensing more safety
- 8 PC. one touch transportation adapter



KT NO.	Max. Capacity	Working pressure (PSI)	Temperature range	Air inlet		
9TV13-100	10 L	90	-19°C~140°C	1/4"	4750	1

Manual Fluid Extractor

9TV21-09

- Capacity : 9 litre
- Use for extracting all types of engines oil, transmission fluid and lubricants of cars, marine, stationary, motorbikes engines etc.



KT NO.	Max. Capacity	Temperature range		
9TV21-09	9 L	-19°C~90°C	4750	1 / 2

- Silicon hose x 1.2 m
- Nylon hose x 1.1 m
- Nylon hose x 1.0 m



Pneumatic Grease Pump 20L

9TU11

- The barrel body is made of high-grade steel plate. It can contain 5 gallons(20L) of barrel packed grease from all nations around the world
- Suitable for all sorts of machinery, vehicles, airplanes, ships, etc. The efficient instrument for infusing grease powerfully for lubrication & maintenance purpose
- Pump of separate type: utilize the principle of liquid getting pumped & driven by air compressor to draw in liquid. There are two independent & separate cycle systems of pump out there, which prevents air- compressor-exhaust moisture from getting to the grease inside the barrel and deteriorating its quality



KT NO.	Air Input Pressure (bar)	Pressure (PSI)	Pressure Ratio	Grease Output Pressure (bar)	Pressure (PSI)	Deliver Rate (cc/sec)	N.W.	G.W.	kg	CUFT
9TU11-20	4-9	60-130	45 :1	180-405	2700-5850	30	17	20.5	21.0	6.4

Hand Grease Pump 20L

9TU21

- 20L tank for 5 gallons grease oil
- Suitable for #00,#0,#1,#2 grease oil
- Included 1.8m length hose & pistol sprayer
- 1/4" High pressure 10,000 psi W.P oilfield hose
- Portable equipment with single pull handle
- Suitable for all sorts of machineries, vehicles, airplanes, ships, etc.



KT NO.	Transmission rate	Hose Length	N.W.	G.W.	CUFT
9TU21-20	4 cc/stroke	1.8 m	8.2 Kg	9.4 Kg	2.2

Oil Transfer Bucket Pump 20L

9TW21

- Lever pump 20 L tank for oil
- Suitable for diesel fuel, lubricating oils up to SAE 90 and Non-corrosive fluids
- Included 1.8m length hose & sprayer
- Portable equipment with single pull handle



KT NO.	Deliver Rate	Hose Length	Outlet tube	N.W.	G.W.	CUFT
9TW21-20	65 cc/stroke	1.8m	3/8"	7.8 Kg	8.5Kg	2.2

ED WHEELS



ST

STARTER

Socket Set

ST2346MR

1/4"

Blow case size (mm) :
254 x 147 x 46 (0.16 cuft)

46
PC.

Contents

1.06 1 / 12

		2335M	4, 4.5, 5, 5.5, 6, 7, 8, 9, 10, 11, 12, 13, 14
		2033	T8, T10, T15, T20, T25, T30, T40
		2035	H3, H4, H5, H6, H7, H8
		2031	PH1, PH2, PH3
		2032	4, 5.5, 7
		2038	PZ1, PZ2, PZ3
		1115-14	H1.27, H1.5, H2, H2.5
		2766-55G	2222-02 2222-04
		2571-45	2312-06
			2179DF



2766DK

Socket Set

ST4028MR

ST4028SR

1/2"

ST4528MR

ST4528SR

1/2"

Blow case size (mm) :
387 x 223 x 58 (0.18 cuft)

24
PC.



ST4028MR/ST4528MR



ST4028SR/ST4528SR



4766DK

KT NO.

Contents

4.10 1 / 4

ST4028MR	4330MRC		8, 9, 10, 11, 12, 13, 14, 15, 16		463021HC
			17, 18, 19, 21, 22, 24, 27, 30, 32		
ST4028SR	4330SRC		5/16", 3/8", 7/16", 15/32"		4766-10G
			1/2", 9/16", 19/32", 5/8", 11/16" 3/4", 25/32", 13/16", 7/8" 15/16", 1", 1-1/16", 1-3/16", 1-1/4"		
ST4528MR	4335MRC		8, 9, 10, 11, 12, 13, 14, 15, 16		463521HC
			17, 18, 19, 21, 22, 24, 27, 30, 32		
ST4528SR	4335SRC		5/16", 3/8", 7/16", 15/32"		4572-12H
			1/2", 9/16", 19/32", 5/8", 11/16" 3/4", 25/32", 13/16", 7/8" 15/16", 1", 1-1/16", 1-3/16", 1-1/4"		
					4251-05RH 4251-10RH
					4791RH

Socket & Wrench Set

SC7083MR

Blow case size (mm) :
422 x 275 x 85 (0.35 cuft)



SC7583MR

1/4"+1/2"



83
PC.

KT NO.	Contents		5.65	1/4
SC7083MR	2330M	4, 4.5, 5, 5.5, 6, 7, 8, 9, 10, 11, 12, 13, 14	1060	8, 10, 11, 12, 13, 14, 17, 19
	4330MRC	14, 15, 16, 17, 18, 19, 20, 22, 24, 27, 30, 32	2031	PH1, PH2
	463016RC		2032	4, 5.5, 6.5
	463021HC		2033	T8, T10, T15, T20, T25, T27, T30
SC7583MR	2335M	4, 4.5, 5, 5.5, 6, 7, 8, 9, 10, 11, 12, 13, 14	2035	H3, H4, H5, H6
	4335MRC	14, 15, 16, 17, 18, 19, 20, 22, 24, 27, 30, 32	2038	PZ1, PZ2
	463516HC		2038	PH3, PH4
	463521HC		1836P	8 x 1.2, 10 x 1.6, 12 x 2.0
			1836S	8 x 1.2, 10 x 1.6, 12 x 2.0
			1836T	T40, T45, T50, T55
			1836H	H8, H10, H12, H14
			1836Z	PZ3, PZ4
		2766-55G	4766-10G	
		4251-05RH	2222-02 2222-04	
		79831	4222-10	
		2312-06	7702-25 3824	
		2571-45H	2179DF	
		414810S	2791 4791RH	

Socket & Wrench Set

SC7396MR

Metal case size (mm) :
422 x 275 x 85 (0.35cuft)

5.5 1/4

Contents		5.5	1/4
2335M	4, 5, 6, 7, 8, 9, 10, 11, 12, 13, 14		
2235M	6, 8, 10, 12, 13, 14		
4335MRC	10, 12, 13, 14, 15, 16, 17, 18, 19, 22, 23, 27, 32		
4535M	15, 16, 17, 19, 24		
1060	8, 10, 12, 13, 14, 15, 16, 17, 18, 19		
1836H	H8, H10, H12, H14		
1836T	T50, T55, T60		
1025S	3.0, 4.0, 5.0, 6.0		
1025P	PH1, PH2 x 2, PH3		
1025Z	PZ1, PZ2 x 2, PZ3		
1025T	T10, T15, T20, T25, T27, T30, T40		
1025H	H3, H4, H5, H6		
1025U	T10H, T15H, T20H, T25H, T27H, T30H, T40H		
1025R	RB2		
753-63			
7702-25			
2766-55G	4766-10G		
2571-45H	2179DF		
4222-10	2222-02 2141		
2791	4791RH 3824 414810S		



96
PC.

Socket & Wrench Set

SC7096MR

Blow case size (mm) :
422 x 275 x 85 (0.35 cuft)

SC7596MR

1/4"+1/2"

**96
PC.**



KT NO.	Contents		Weight 6.22	Volume 1/4	
SC7096MR	2330M	4, 4.5, 5, 5.5, 6, 7, 8, 9, 10, 11, 12, 13, 14	2031	PH1, PH2	2766-55G
	2230M	6, 7, 8, 9, 10, 11, 12, 13	2032	4, 5.5, 6.5	4766-10G
	4230MC	14, 15, 17, 19, 22	2033	T8, T10, T15, T20, T25, T27, T30	2179DF
	4330MRC	10, 11, 12, 13, 14, 15, 16, 17, 18, 19, 20, 21, 22, 24, 27, 30, 32	2035	H3, H4, H5, H6	4222-10
	463016RC		2038	PZ1, PZ2	2222-02
	463021HC		1836P	PH3, PH4	2222-04
SC7596MR	2335M	4, 4.5, 5, 5.5, 6, 7, 8, 9, 10, 11, 12, 13, 14	1836S	8x1.2, 10x1.6, 12x2.0	4251-05RH
	2235M	6, 7, 8, 9, 10, 11, 12, 13	1836T	T40, T45, T50, T55	2571-45H
	4235MC	14, 15, 17, 19, 22	1836H	H7, H8, H10, H12, H14	2791
	4335MRC	10, 11, 12, 13, 14, 15, 16, 17, 18, 19, 20, 21, 22, 24, 27, 30, 32	1836Z	PZ3, PZ4	4791RH
	463516HC		1115-03	1.5, 2, 2.5	414810S
	463521HC				3824

Socket & Wrench Set

SC7010MR

Blow case size (mm) :
422 x 275 x 85 (0.35 cuft)



SC7510MR





























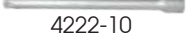











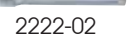



















SC7510MR

1/4"+1/2"



SC7010MR

110
PC.

KT NO.	Contents		kg 6.90	1 / 4
SC7010MR	  2330M 4, 4.5, 5, 5.5, 6, 7, 8, 9, 10, 11, 12, 13, 14	  2375M E4, E5, E6, E7, E8		2766-55G
	  2230M 6, 7, 8, 9, 10, 11, 12, 13	  4375M E10, E11, E12, E14, E16, E18, E20, E24		4766-10G
	  4230MC 14, 15, 17, 19, 22	  2031 PH1, PH2		2179DF
	  4330MRC 10, 11, 12, 13, 14, 15, 16, 17, 18, 19, 20, 21, 22, 24, 27, 30, 32	  2032 4, 5.5, 6.5		4222-10
	  463016RC   463021HC	  2033 T8, T10, T15, T20, T25, T27, T30		2571-45H
SC7510MR	  2335M 4, 4.5, 5, 5.5, 6, 7, 8, 9, 10, 11, 12, 13, 14	  2035 H3, H4, H5, H6		2222-02 2222-04
	  2235M 6, 7, 8, 9, 10, 11, 12, 13	  2038 PZ1, PZ2		4251-05RH
	  4235MC 14, 15, 17, 19, 22	  1836P PH3, PH4		2791 4791RH
	  4335MRC 10, 11, 12, 13, 14, 15, 16, 17, 18, 19, 20, 21, 22, 24, 27, 30, 32	  1836S 8x1.2, 10x1.6, 12x2.0		3824
	  463516HC   463521HC	  1836T T40, T45, T50, T55, T60		414810S
	  1836H H7, H8, H10, H12, H14		7702-25	
	  1836Z   1115-03 1.5, 2, 2.5		2745	

Socket & Wrench Set

SC9043MR

Blow case size (mm) :
560 x 400 x 110 (0.87 cuft)



SC9543MR

1/4"+3/8"+1/2"



143
PC.

KT NO.	Contents		13.7	1/2
SC9043MR	2330M 4, 4.5, 5, 5.5, 6, 7, 8, 9, 10	2375M E4, E5, E6, E7, E8	1060 6, 7, 8, 9, 10, 11, 12, 13, 14, 15, 16, 17, 18, 19, 21, 22, 24	
	4330MRC 8, 10, 12, 13, 14, 15, 16, 17, 18, 19, 20, 21, 22, 23, 24, 25, 27, 30, 32	3330M 6, 7, 8, 9, 10, 11, 12, 13, 14, 15, 17, 18, 19, 21, 22	1930 8 x 10, 10 x 12, 11 x 13, 12 x 14, 17 x 19	
	463016RC 463021HC	4375MC E10, E12, E14, E16, E20	1145MR H1.5, H2, H2.5, H3, H4, H5, H6, H8, H10	
		1025P PH0, PH1, PH2, PH3	2222-02 2222-04 2222-06	3221-03 3221-06 4251-03R
		1025S 4, 5.5, 7	4222-10	2312-06 2179DF
		1025U T10H, T15H, T20H, T25H, T27H, T30H, T40H	3781-11F	4452-18FR 2141
SC9543MR	2335M 4, 4.5, 5, 5.5, 6, 7, 8, 9, 10	1025H H2, H3, H4, H5, H6, H7, H8, H10	4581-10	79831 6111-07
	4335MRC 8, 10, 12, 13, 14, 15, 16, 17, 18, 19, 20, 21, 22, 23, 24, 25, 27, 30, 32	1025Z PZ0, PZ1, PZ2, PZ3	2766-55G	4766-10G 6011-10R
	463516HC 463521HC	1421 PH2 x 38, PH1 x 80	79093-03M	3824 3812 2791 3792 4791RH
		1461 PH2 x 100	7821-30	
		1422 6.5 x 38, 5.5 x 75		
		1462 6.5 x 150		

Ball Hex Key

ST1120MR



- Extra long arm with ball point type
- DIN ISO 2936



KT NO.	mm	mm	mm	mm	mm
ST112012MR	H12	57	262	283	8 / 48
ST112014MR	H14	70	294	441	8 / 48
ST112017MR	H17	80	337	740	4 / 32
ST112019MR	H19	89	379	1044	4 / 16

ST1145MR



- Standard arm type
- Hex head
- DIN ISO 2936



KT NO.	mm	mm	mm	mm	mm
ST114512MR	H12	57	137	166	10 / 120
ST114514MR	H14	70	154	261	6 / 72
ST114517MR	H17	80	177	439	4 / 48
ST114519MR	H19	89	199	619	4 / 32

Hex Key Set

ST20219MR



9
PC.

Spec.	Contents	mm	mm	mm	mm
Standard arm	●	H1.5, H2, H2.5, H3, H4, H5, H6, H8, H10	300	6 / 48	

ST20209MR



9
PC.

Spec.	Contents	mm	mm	mm	mm
Extra long arm	●	H1.5, H2, H2.5, H3, H4, H5, H6, H8, H10	480	8 / 48	

ST20213MR



13
PC.

Spec.	Contents	mm	mm	mm	mm
Standard arm hex-head key	●	H2, H2.5, H3, H4, H5, H6, H7, H8, H10, H12, H14, H17, H19	1880	2 / 8	

ST20208MY



8
PC.

Spec.	Contents	mm	mm	mm	mm
Extra long arm	●	H2, H2.5, H3, H4, H5, H6, H8, H10	480	8 / 48	

Hex Key Set

ST20109MR



9
PC.

Spec. Contents 0.48 / 8 / 48

Extra long arm / ball — ST1120MR H1.5, H2, H2.5, H3, H4, H5, H6, H8, H10

ST20419PR



9
PC.

Spec. Contents 470 / 8 / 48

Extra long arm / Tamper resistant — ST1127R T10H, T15H, T20H, T25H, T27H, T30H, T40H, T45H, T50H

ST20203MR



13
PC.

Spec. Contents 330 / 1 / 4

Extra long arm / ball — ST1120MR H2, H2.5, H3, H4, H5, H6, H7, H8, H10, H12, H14, H17, H19

ST20203SR



13
PC.

Spec. Contents 330 / 1 / 4

Extra long arm / ball — ST1120SR 5/64, 3/32, 1/8, 5/32, 3/16, 7/32, 1/4, 5/16, 3/8, 1/2, 9/16, 5/8, 3/4

Tool Trolley

ST87432-5B

5 Drawer & 7 Drawer Tool Trolley

- Heavy duty ball bearing slides
- 5"x1-1/4" casters with locking break
- One piece wall constructed and powder coating
- Central locking system
- Oil can holder / optional side pull handle bar
- 2mm anti-slipping rubber top mat
- Overall size : W670 x D460 x H812 mm

ST87432-5B 52 CUFT 12.64
ST87434-7B 60

ST87434-7B



ST87432-5B



ST87434-7B

01

HAND SOCKET



02

RATCHET



03

COMBINATION
WRENCH



04

PHILLIPS
SCREWDRIVER



05

PORTABLE
TOOL BOX



06

SHELF TROLLEY



07

WORKBENCH

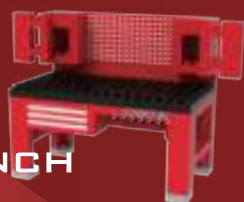

08

MEASURING
TAPE



TOOL DIAMOND BLOCKS

SET A

TS00108



WARNING:

CHOKING HAZARD
SMALL PARTS, NOT FOR
CHILDREN UNDER 3 YEARS



01

IMPACT SOCKET



02

IMPACT WRENCH



03

COMBINATION
PLIERS



04

SLOTTED
SCREWDRIVER



05

RATCHET
TUBING CUTTER

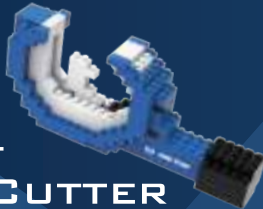

06

TOOL TROLLEY



07

LED LAMP



08

TOOL BOX



TOOL DIAMOND BLOCKS

SET B

TS00208



WARNING:
CHOKING HAZARD
SMALL PARTS, NOT FOR
CHILDREN UNDER 3 YEARS





Promotional Merchandise

Business & Office

Leather Male Wallet



ZS104

Size : 115 x 90 mm

Briefcase (Leather)



ZS107

Size : 400 x 350 x 80 mm

Leather Belt (Male)



ZS108

Ball-Bearing Pen



ZS402

Notepaper



ZS517

Size : 75 x 75 mm

Mat

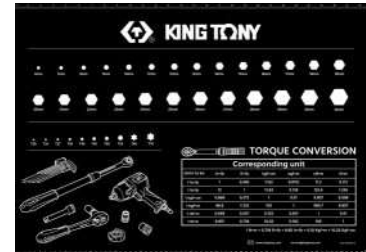

Ball-Bearing Pen



ZS405

Mouse Pad



ZS306

Size : 180 x 180 x 3 mm

Ruler 30cm



ZS408

A4 Shape Clear File



ZS409

Size : 310 x 220 mm

Mat



ZS411

Size : 530 x 367 x 2 mm



ZS418K

new

Size : 700 x 500 x 2 mm

Leisure Products

Golf Umbrella



ZS116

Size : 68 x 8K

Personal Cooler Bag



ZS120-S

new

Size : 290 x 150 x 210 mm
Weight : 352g

Handbag



ZS119

Size : 360 x 380 x 100 mm

Paper Cup



ZS511

Coaster

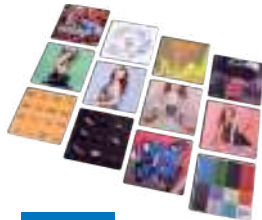

ZS514

Size : 99 x 99 mm

Stainless Grilling & Barbecue Utensils



ZS572

Mug



ZS606

new

Size : 900 x 240 mm
Capacity : 550ml

Beach Towel



ZS155

ZS155A

Size : 740 x 1400mm
80% Polyester
20% Nylon

Door mat



ZS417

new

Size :
600 x 900 x 08mm
PVC

Merchandise

Mini Pocket Tools



ZS522

Mini Pocket Tools



ZS524

Key Ring



ZS533

Mini Pocket Tools



ZS540

Clothes

Work Clothing



ZS109

	Overall	Waist.(inch)	Hip(inch)
ZS109 - L	34"	48"	48"
ZS109 - XL	36"	50"	50"
ZS109 - 2L	38"	52"	52"
ZS109 - 3L	41"	54"	54"

Work Clothing



ZS112

	Overall	Waist.(inch)	Hip(inch)
ZS112 - L	36"	44"	44"
ZS112 - XL	40"	48"	48"
ZS112 - 2L	44"	52"	52"
ZS112 - 3L	48"	56"	56"

Work Hat



ZS110

Hoodie



ZS146

	Overall	Chest girth (inch)
ZS146 - S	51"	51"
ZS146 - M	53"	53"
ZS146 - L	56"	56"
ZS146 - XL	61"	61"
ZS146 - 2L	64"	64"

Windbreaker Jacket



ZS141

	Overall	Chest girth(inch)
ZS141 - S	44"	44"
ZS141 - M	46"	46"
ZS141 - L	48"	48"
ZS141 - XL	50"	50"
ZS141 - 2L	52"	52"
ZS141 - 3L	54"	54"

T-shirt



ZS142W



ZS142B

	Overall	Shoulder width (inch)	Chest girth (inch)
S	16"	38"	38"
M	17"	40"	40"
L	18"	42"	42"
XL	18-1/2"	44"	44"
2L	19"	46"	46"
3L	19.5"	48"	48"

Polo-shirt



ZS126

new

	Length (inch)	Sleeve length (inch)	Chest girth (inch)	Shoulder width (inch)
ZS126 - S	27"	9"	41"	18"
ZS126 - M	27.5"	9"	43"	19"
ZS126 - L	28"	10"	45"	20"
ZS126 - XL	29"	10"	47"	20.5"
ZS126 - 2L	29"	10"	50"	21.5"



Sales Support

Small Flag

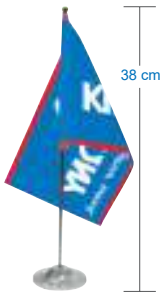

ADFLAG

Size : 254 x 160 mm

Big Flag



ADFLAG1

Size : 930 x 1430 mm

Outdoor Flag



ADFLAG2

Size : 2100 x 600 mm

Canvas Strip



ADCV-01



ADCV-02

Size : 3000 x 800 mm

Stickers



ADSTK21KT 909 x 450 mm

ADSTK22KT 506 x 226 mm

ADSTK23KT 264 x 42 mm

Stickers



ADSTK31KT

Size : 660 x 160 mm

Stickers



ADSTK-C1

Size : ø - 250 mm



ADSTK-H2

Size : ø - 250 mm

Folding Tent



ZS115

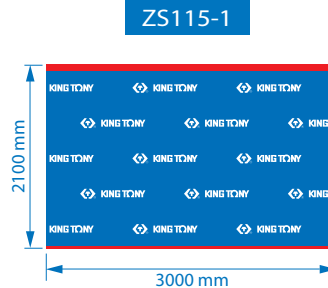

ZS115-1

- Quick and easy to set up
- Tent roof made of high quality 600D fabric
- Waterproof and UV resistant
- Full structure made of robust steel
- Adjustable height, max to 3400 mm
- Includes practical carrier bag

KT NO.	Spec.	Height (mm)	kg	Box
ZS115	3000 x 3000 mm (not included ZS115-1)	3400	22	1 / 1
ZS115-1	2100 x 3000 mm Side curtain	-	0.9	1 / 15

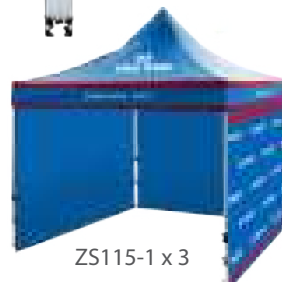

ZS115-1 x 3



- Full truss structure



- Hanging capacity up to 70 kgs



- Foot pad comes with stake hole

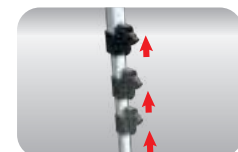

- 3 section of height adjustment

Display Stand Series

Display Stand



87306A

Overall Size -
W 1000 x D 500 x H 2200 mm
Attachment-
1 PC. lamp case
2 PC. shelve
6 PC. steel plate with hole
40 PC. Black hooks
(170 x Ø3.6mm)
Weight - 46 Kg / Cuft - 5.9

Double-sided Display Stand



87307A

Overall Size -
W 1000 x D 960 x H 2200 mm
Attachment-
2 PC. Lamp case(1 LED , 2 spotlights)
4 PC. Shelve
12 PC. Steel plate with hole
40 PC. Hooks
Weight - 75 Kg / Cuft - 12.16

Display Board



87203

Wall hanging type 30 PC. hook included
Overall Size -
W 725 x D 14 x H 900 mm
Weight - 11.50 Kg / Cuft - 0.328

Display Hook



- 87301-494A 4" x Ø 4 mm
- 87301-496A 6" x Ø 5.2 mm
- 87301-498A 8" x Ø 5.2 mm
- 87301-499A 9" x Ø 8 mm

Display Stand



87301-36(White)

Overall Size -
W 902 x D 268 x H 143 mm
Weight - 6.5 Kg / Cuft - 0.62



Hammer Hook



91431

Overall Size -
W 40 x D 210 x H 240 mm
Weight - 411.6 g / Cuft - 0.072

Steel Rack Hook



91432

Idea for hanging display & presenting tool set
230mm maximum depth
5kg maximum tool weight (heavier & longer items, you can put 2 PC. to hold)

Impact Wrench Hook



- 91451-01A(1/4"-19 BSPT)
- 91451-01B(1/4"-18 NPT)
- 91451-01F(1/4"-19 BSPT)

Wrench Display

87157-06

Capacity : 6 PC.
For all measuring tape
(1900 27x30~41x46 Series)
Size:100x100x46mm
Weight - 0.22 Kg
Cuft - 0.72

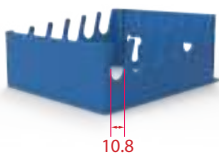

Wrench Display

87157-09

Capacity : 9 PC.
For all measuring tape
(1900 5.5x7~27x29 Series)
Size:100x100x46mm
Weight - 0.22 Kg
Cuft - 0.72

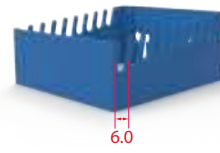

Side Panel for Display Stand



ADTV-04
Size : 900 x 240 mm

Side Panel for Display Stand



ADTV-05
Size : 900 x 240 mm

Magnetic Base



91422

Display Shelf Magnets



ADVT-03X
Size : 960 x 55 mm

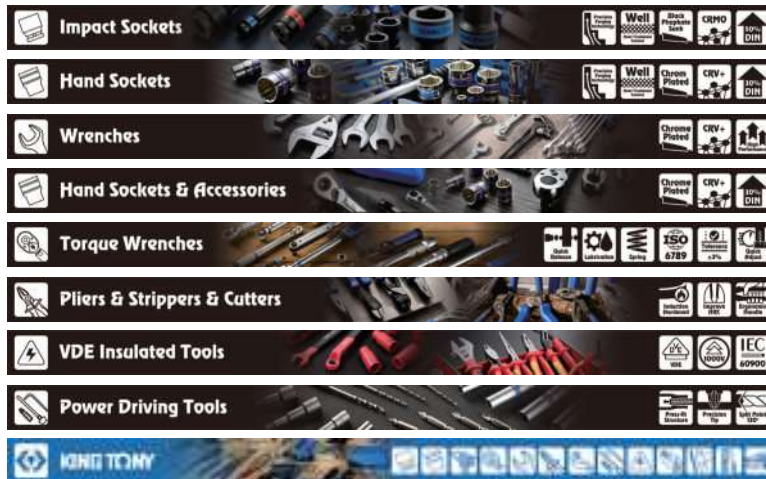

- ADVT-031
- ADVT-032
- ADVT-033
- ADVT-034
- ADVT-035
- ADVT-036
- ADVT-037
- ADVT-038
- ADVT-039

Tool Display

Display Shelf for L-wrench



87125
Overall Size - W 220 x D 260 x H 5 mm
Weight 135g / Cuft 1.10
Reference : 2020HOMR

Display Stand



87152
Overall Size -W400 x D230 x H470 mm
Weight - 1.20 Kg / Cuft - 1.53

Display Rack for Torque Wrench



87153
Overall Size -W 330 x D 255 x H 475 mm
Weight - 1.23 Kg / Cuft - 1.41

Tools Display Stand

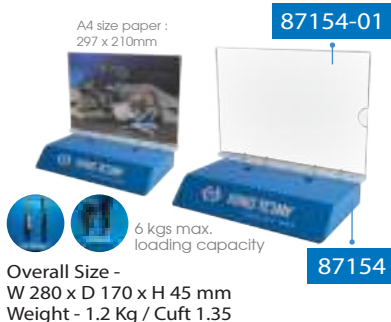

A4 size paper : 297 x 210mm
87154-01
6 kgs max. loading capacity
87154
Overall Size - W 280 x D 170 x H 45 mm
Weight - 1.2 Kg / Cuft 1.35

Impact Wrench Display Stand

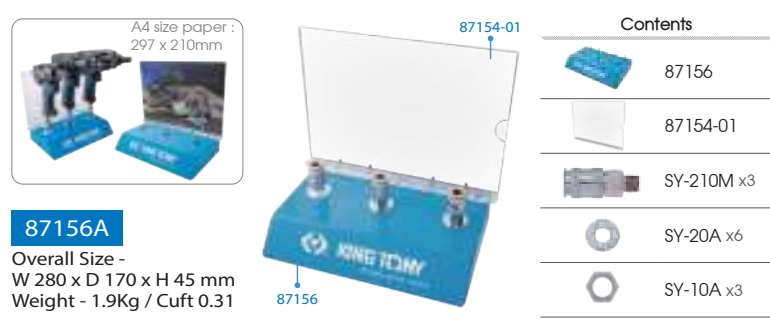

A4 size paper : 297 x 210mm
87156A
Overall Size - W 280 x D 170 x H 45 mm
Weight - 1.9Kg / Cuft 0.31
87156

Contents	
	87156
	87154-01
	SY-210M x3
	SY-20A x6
	SY-10A x3

Socket Shelf



87102

87103

Width can be adjustable to display multiple socket series
Single serial socket size tab attached

Overall Size -
W 415 x D 336 x H 320 mm
Weight - 6.85 Kg(87102)
6.37 kg(87103)
Cuft - 0.67

Reference:
3568MR
4072MR / 4572MR
4072SR / 4572SR
4066MR / 4566MR
4066SR
4472MP/4472SP
4466MP/4466SP

Screwdriver Shelf



87105

87107

87111

87105-W 595 x D 240 x H 210 mm
Weight - 3.40 Kg Cuft - 1.97
87107-W 383 x D 136 x H 130 mm
Weight - 0.86 Kg
87111-W 655 x D 240 x H 210 mm
Weight - 3.80 Kg Cuft - 2.2

Reference:
87105 (31416MR)
(31516MR)
87107 (31419MR)
87110 (31512MR)
87111 (31519MR)

Impact Wrench Display Stand



- 871061A(1/4"-19 BSPT)
- 871061B(1/4"-18 NPT)
- 871061F(1/4"-19 BSPT)

Reference :
Applied for 3/8" & 1/2" DR. air tools

Screwdriver Shelf



87104

Overall Size -
W 325 x D 205 x H 270 mm
Weight - 1.20 Kg Cuft - 0.3

Metal Holder for Flat Chisel



87108

Metal Holder





























































































8711B

Overall Size -
W 600 x D 240 x H 60 mm
Weight - 6.20 Kg
Cuft - 0.9
Reference :
1090PR1









































Sign List

 Internal hexagon	 External hexagon	 Bi-hexagon	 Spline head	 Spline head - tamper resistant	 Internal torx	 External torx	 External torx - tamper resistant	 Double square
 torx plus-tamper resistant	 torx plus	 Ribe bit socket	 Phillips head	 Slotted head	 Pozidriv	 PlusMinus	 Internal square	 External square
 External square	 Ribe socket 12 mm	 Ribe socket 10 mm	 Axial lock nut	 Square	 Crowfoot	 Hook wrench	 External KM locknut	 Internal KM locknut
 Speical profile for wheel nut	 Claw Pickup	 Internal square	 Hexagon	 Pentagon	 Ball hex	 Flat face - round	 Flat face - square	 Milled square face
 Internal circlip	 External circlip	 Thin serrated	 Coarse serrated	 Smooth	 With opening spring	 Round jaws	 Half-round jaws	 Flat & point jaws
 Soft wire	 Medium hard wire	 Hard wire	 Piano wire	 Europe	 America & Asia	 Australia & New Zealand	 English	 Australia
 Changeable blade	 Guide rollers	 Cutter wheel	 Outside diameter (O.D.)	 Wall thickness	 Inside diameter (I.D.)	 Capacity of open jaw (mm)	 Diameter	
 Center cut	 With bevel	 With small bevel	 With very small bevel	 Without bevel				
 Max. torque	 Air inlet	 Free speed	 Air pressure	 Std. bolt size	 Air hose	 Anvil type	 Avg. air consumption	 Sound
 Vibration level	 Litre capacity	 Q'ty / Carton	 Q'ty / Box	 Q'ty / Bag	 Q'ty / Blister card	 Weight (g)/(kg)		
 Light weight	 1000V	 ESD	 ISO	 CE certificate	 VDE certificate	 G.S. approval	 TUV certificate	



 HGV	 Commercial Vehicles	 Small commercial vehicles	 Passenger cars	 Buses	 Construction vehicles	 Agricultural machinery	 Motorcycles	 Engine series
 Agricultural machinery-tiller	 Chassis	 Steel construction	 Assembly line	 Factory	 Diesel engine	 Petrol engine	 Timing belt	 Timing chain
 Strobe	 IP Protection	 Adjustable lighting	 Lumen	 Lighting for hours	 Watt	 Adjustment button	 Thickness	 Magnetic
 USB cable	 USB charger	 Cable length	 Charging time	 DC charger	 AC charger	 Li-ion battery	 Battery	 IK07/ IP20
 10 cm range								

Information-General Safety Recommendations



CAUTION



Please wear proper safety gear while working.

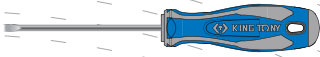

It all fits together

■ DIN screwdrivers









Slotted screws		Size										
		2x0.4	2.5x0.4	3x0.5	3.5x0.6	4x0.8	5.5x1	6.5x1.2	8x1.2	10x1.6		
Metric screws												
Flat head												
	ISO 2009		1.6	2	2.5	3	3.5	4	5			
	DIN 963		1.6	2	2.5	3	3.5	4	5			
Oval head												
	ISO 2010		1.6	2	2.5	3	3.5	4	5			
	DIN 964		1.6	2	2.5	3	3.5	4	5			
Cheese head												
	ISO 1207						3.5	4	5	6		
	DIN 84		1.6	1.8	2	2.5		4	4	5	6	
Pan head												
	ISO 1580		1.6	2	2.5	3	3.5	4	5	6		
	DIN 85					3	3.5	4	5		6	
	DIN 920		2.5	3/3.5	4	5	6	8		10		
	DIN 921		1.6	2	2.5	3	3.5	4		5	6	
Set												
	ISO 4766	DIN 551	2.5	3.5	4	5	6	8				
	7435	417	3									
	ISO 4735	DIN 427	2.5	3.5	4	5	6	8		14		
			3									
Self tapping screws												
Flat head												
	ISO 1482				2.2		2.9	3.5	4.2	4.8		
	DIN 7972				2.2		2.9	3.5	3.9	4.8		
Oval head												
	ISO 1483				2.2		2.9	3.5	4.2	4.8		
	DIN 7973				2.2		2.9	3.5	3.9	4.2	4.8	6.3
Pan head												
	ISO 1481				2.2		2.9	3.5	4.2	4.8	5.5	6.3
	DIN 7971					2.9	2.9	3.5	4.2	4.8	5.5	6.3

Phillips + Pozidriv		Size					
		00	0	1	2	3	4
Metric screws							
Flat head							
	ISO 7046	DIN 965	1.6	2.5	3.5	6	8
			2	3	5	10	
Oval head							
	ISO 7047	DIN 966	1.6	2.5	3.5	6	8
			2	3	5	10	
Pan head							
	ISO 7045	DIN 7985	1.6	2.5	3.5	6	8
			1.8	3	5	10	
Self tapping screws							
Flat head							
	ISO 7049	DIN 7981		2.2	3.5	5.5	
				2.9	4.8	6.3	
Oval head							
	ISO 7050	DIN 7982		2.2	3.5	5.5	
				2.9	4.8	6.3	
Pan head							
	ISO 7051	DIN 7983		2.2	3.5	5.5	
				2.9	4.8	6.3	
ANSI screws			0-1	2-4	5-10	12-16	18-...

■ How to find the correct screwdriver









	Slotted	Phillips	Pozidriv	Torx	Torx	Square	Hex	Nut
Classic Screwdriver	1412	1411						
SoftFinish Screwdriver	1422	1421	1428	1423	1427	1424		
Classic Screwdriver (Heavy Duty)	1482	1481						
SoftFinish Screwdriver (heavy Duty)	1462	1461						
Nutspinner								1450 5450 1453
SoftFinish Electric	1472	1471	1478					
Precision Screwdriver	1432	1431		1433				
Exchangeable ratchet Screwdriver	32809	32809		32809				
Two-way screwdriver	2411 1317 2431	2411 1317 2431	1317	1317 2433			1317	32810
Torque Screwdriver							3411	



			For torx head screw											
			T5	T6	T7	T8	T9	T10	T15	T20	T25	T27	T30	T40
mm			1.42	1.70	1.99	2.31	2.50	2.74	3.27	3.86	4.43	4.99	5.52	6.65
Metric screws														
	ISO 4762	DIN 912	*	2	*	2.5		3		4	5	**	6	
	ISO 4760	DIN 963 965	*	*	*	2.5		3	3.5	4	5	**	6	8
	ISO 7047 2010	DIN 964 966	*	2	*	2.5		3	3.5	4	5	**	6	
		DIN 7984 6912	*	*	*	2.5		3		4	5	**	6	
	ISO 7045	DIN 7985	*	2	*	2.5		3	3.5	4	5	**	6	
	ISO 10642	DIN 7991	*	*	*	2.5		3		4	5	6	**	8
Self tapping screws														
	ISO 7049	DIN 7981 7982	*	2.2	*	2.9		3.5	3.9	4.2 5.5	4.8	**	6.3	
	ISO 7050	DIN 7972 7983	*	2.2	*	2.9		3.5	3.9	4.2	4.8 5.5	**	6.3	
	ISO 7051	DIN 7973	*	2.2	*			3.5	3.9	4.2	4.8 5.5	**	6.3	8

* Screws for tungsten carbide inserts

** Special screws

Index		
ISO	International standard	
DIN	German standard	
M 	Metric screws	Thread diameter
M 	Set screw metric	Thread diameter
M 	Metric nut	Thread diameter
B 	Self tapping screw	Thread diameter
Symbols		
Tool drive = screwdriver socket		
for screws with internal drive		
Tool drive = Nutdriver socket		
for screws with head drive		





Bits / Sockets for S size

 TORX internal screw		T5	T6	T7	T8	T9	T10	T15	T20	T25	T27
	⚙️ S(ref.mm)	1.42	1.7	2	2.32	2.5	2.74	3.28	3.86	4.43	4.99
	Screws(ref)	M1.5	M2	M2.5	M2.5	M3	M3/M3.5	M3.5/M4	M4/M5	M4.5/M5	M4.5/M5/M6
		T30	T40	T45	T50	T55	T60	T70	T80	T90	T100
	⚙️ S(ref.mm)	5.52	6.65	7.82	8.84	11.23	13.26	15.54	17.58	19.95	22.16
	Screws(ref)	M6/M7	M7/M8	M8/M10	M10	M12	M14	M16	M18	M20	M22

 SPLINE		M4	M5	M6	M8	M10	M12	M14	M16	M18	M20
	⚙️ S(ref.mm)	3.6	4.8	6	7.2	9.6	11.41	13.22	15.63	16.85	19.25
	Screws(ref)	M4	M5	M6	M8	M10	M12	M14	M16	M18	M20

 RIBBLE		M5	M6	M7	M8	M9	M10	M12	M13	M14	M16
	⚙️ S(ref.mm)	5	6	7	8	9	10	12	13	14	16
	⚙️ W(ref.mm)	1.1	1.3	1.4	1.7	1.9	2.2	2.6	3	3.1	3.5
	Screws(ref)	M6	M8		M10	M10	M12				

 IPR		IPR8	IPR9	IPR10	IPR15	IPR20	IPR25	IPR27	IPR30	IPR40	IPR45	IPR50	IPR55	IPR60
	⚙️ S(ref.mm)	2.14	2.33	2.58	3.07	3.63	4.16	4.70	5.22	6.27	7.32	8.32	10.54	12.45

 TORX external screw		E4	E5	E6	E7	E8	E10	E11	E12	E14	E16	E18	E20
	⚙️ S(ref.mm)	3.83	4.72	5.69	6.17	7.47	9.37	10.03	11.12	12.85	14.71	16.64	18.41
	Screws(ref)	M3	M4	M5	M6	M6/M7	M8	M8/M10	M10	M12	M12	M14	M16
		E22	E24	E26	E28	E30	E32	E34	E36	E38	E40	E42	E44
	⚙️ S(ref.mm)	20.24	22.1	23.85	25.65	27.38	29.16	30.96	32.82	34.67	36.37	38.2	39.98
	Screws(ref)	M18	M18/M20										

 SQUARE		RB00	RB0	RB1	RB2	RB3	RB4
	⚙️ S(ref.mm)	1.30	1.80	2.30	2.86	3.38	4.85

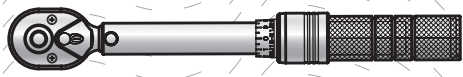

Torque Data

Bolt	Nut	Washer	Bolts and nuts classes (SAE threads, triangular shape, high pitch 0.15 coefficient)					
			4.8 Torque N · m	5.8 Torque N · m	6.8 Torque N · m	8.8 Torque N · m	10.9 Torque N · m	12.9 Torque N · m
M3	5.5	2.5	0.64	0.8	0.91	1.21	1.79	2.09
M4	7	3	1.48	1.83	2.09	2.78	4.09	4.79
M5	8	4	2.93	3.62	4.14	5.5	8.1	9.5
M6	10	5	5	6.2	7.1	9.5	14	16.4
M8	13	6	12.3	15.2	17.4	23	34	40
M10	16	8	24	30	34	46	67	79
M12	18	10	42	52	59	79	116	136
M14	21	12	67	83	94	127	187	219
M16	24	14	105	130	148	198	291	341
M18	27	14	145	179	205	283	402	471
M20	30	17	206	254	291	402	570	667
M22	34	17	283	350	400	552	783	917
M24	36	19	354	438	500	691	981	1148
M27	41	19	525	649	741	1022	1452	1700
M30	46	22	712	880	1005	1387	1969	2305
M33	50	24	968	1195	1366	1884	2676	3132
M36	55	27	1242	1534	1754	2418	3435	4020
M39	60		1614	1994	2279	3139	4463	5223
M42	65	32	1995	2464	2816	3872	5515	6453
M45	70		2497	3085	3525	4847	6903	8079
M48	75	36	3013	3722	4254	5849	8330	9748
M52	80		3882	4795	5480	7535	10731	12558
M56	85	41	4839	5978	6832	9394	13379	15656
M60	90		6013	7428	8490	11673	16625	19455
M64	95	46	7233	8935	10212	14041	19998	23402

* In order not over-tighten the fastener, please refer manufacturer's service manual, or TORQUE DATA for tightening torque information

* Torque tightening is refer to "thread dimension" of screw, which is M3~M64 size mention above table

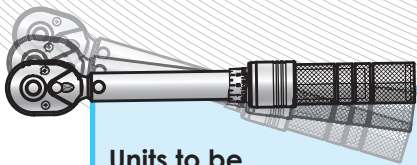

Torque Conversion

Units to be	Corresponding unit					
	in · lb	ft · lb	kgf · cm	kgf · m	cN · m	N · m
1 in · lb	1	0.083	1.152	0.0115	11.3	0.113
1 ft · lb	12	1	13.83	0.138	135.6	1.356
1 kgf · cm	0.868	0.072	1	0.01	9.807	0.098
1 kgf · m	86.8	7.233	100	1	980.7	9.807
1 cN · m	0.088	0.007	0.102	0.001	1	0.01
1 N · m	8.851	0.738	10.20	0.102	100	1

$$1 \text{ N} \cdot \text{m} = 0.738 \text{ ft} \cdot \text{lb} = 8.85 \text{ in} \cdot \text{lb} = 0.10 \text{ Kgf} \cdot \text{m} = 10.20 \text{ Kgf} \cdot \text{cm}$$

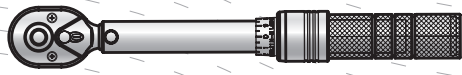

Torque Data

IMPERIAL

	 threads per inch	Bolts and nuts classes (SAE threads, triangular shape, high pitch 0.15 coefficient)			
		 Torque ft · lb	 Torque ft · lb	 Torque ft · lb	 Torque ft · lb

Coarse Thread Series

Size	Threads per inch	307A A Torque (ft · lb)	5 Torque (ft · lb)	8 Torque (ft · lb)	9 Torque (ft · lb)
1/4	20	32 in · lb	76 in · lb	107 in · lb	126 in · lb
5/16	18	66 in · lb	157 in · lb	221 in · lb	259 in · lb
3/8	16	10	23	33	38
7/16	14	16	37	52	61
1/2	13	24	57	80	94
9/16	12	35	82	115	135
5/8	11	48	113	159	186
3/4	10	85	200	282	331
7/8	9	136	322	455	533
1	8	204	483	681	799
1-1/4	7	409	840	1363	1597
1-1/2	6	711	1462	2371	2779

Fine Thread Series

Size	Threads per inch	307A A Torque (ft · lb)	5 Torque (ft · lb)	8 Torque (ft · lb)	9 Torque (ft · lb)
1/4	28	37 in · lb	87 in · lb	123 in · lb	144 in · lb
5/16	24	73 in · lb	174 in · lb	245 in · lb	287 in · lb
3/8	24	11	26	37	43
7/16	20	18	41	58	68
1/2	20	27	64	90	105
9/16	18	39	91	128	151
5/8	18	54	127	180	211
3/4	16	94	223	315	369
7/8	14	150	355	502	588
1	14	229	542	765	896
1-1/4	12	453	930	1509	1768
1-1/2	12	800	1645	2668	3127

* note : Torque-Tension relationship for ASTM A307 Grade A(SAE J2), SAE J429 Grade 5, SAE J429 Grade 8 & FNL Grade 9 Bolts

* note : Torque values for 1/4" and 5/16" are in in·lb. All other torque values are in ft·lb

Hanger No. List

	Hanger No.	Suitable Size	Hanger No. (with product)
Socket Hanger for 1/4" DR. Socket	08782100  + 	1/4"DR. Socket	 KT No. & D1
Socket Hanger for 3/8" DR. Socket	08783100  + 	3/8"DR. Socket	 KT No. & D1
Socket Hanger for 1/2" DR. Socket	08784100  + 	1/2"DR. Socket	 KT No. & D1
Socket Hanger for 3/4" DR. Socket	08786100  + 	3/4"DR. Socket	 KT No. & D1
Hanger for 1/4" DR. Accessories	08782102  + 	1/4"DR. Ratchet, sliding T-handle, flexible handle	 KT No. & D1
Hanger for 3/8" DR. Accessories	08783102  + 	3/8"DR. Ratchet, sliding T-handle, flexible handle	 KT No. & D1
Hanger for 1/2" DR. Accessories	08784102  + 	1/2"DR. Ratchet, sliding T-handle, flexible handle	 KT No. & D1
Hanger for Wrench	8781103 choose suitable hangers according to different sizes  +  + 	For example,1060 6~9mm	 KT No. & D1
Hanger for Wrench & Nut Spinner	8781100 choose suitable hangers according to different sizes  +  + 	For example,1060 10~19mm & nut spinner	 KT No. & D1
Hanger for Wrench	8781101 choose suitable hangers according to different sizes  +  + 	For example,1060 20~23mm	 KT No. & D1
Hanger for Wrench	8781102 choose suitable hangers according to different sizes  +  + 	For example,1060 24~32mm	 KT No. & D1
Hanger for Speed Wrench	087837(size)KT  + 	Speed wrench, open-side speed wrench size, 8~24mm	 KT No. & D1
Hanger for Screwdriver	8785100 choose suitable rubber rings according to different sizes  +  + 	Screwdriver, hex key, spline L-wrench, star L-wrench, L-type wrench, T-type wrench	 KT No. & D1
Hanger for Power Driving	8785001  + 	Power driving 9.5mm groove	 KT No. & D1

Index

10 xxx

1005APR.....	472	102505S1.B	388	102530V	388	1060-18	322	1063-30	324	1081-10	341
1005GQ.....	495	102506H	388	102535S1	388	1060-19	322	1063-32	324	1081-11	341
1006APR.....	472	102506H.B	388	102535S1.B	388	1060-20	322	1067-06	324	1081-12	341
1006GPN.....	474	102506M	388	102535T	388	1060-21	322	1067-07	324	1081-13	341
1006PR.....	473	102506S1	388	102535T.B	388	1060-22	322	1067-08	324	1081-14	341
1006PRN.....	473	102506S1.B	388	102540T	388	1060-23	322	1067-09	324	1081-15	341
1009GPN.....	474	102506T	388	102540T.B	388	1060-24	322	1067-10	324	1081-16	341
1009PR.....	473	102506T.B	388	102540U	388	1060-25	322	1067-11	324	1081-17	341
1009PRN.....	473	102507H	388	102540U.B	388	1060-26	322	1067-12	324	1081-18	341
1010CMR.....	406	102507H.B	388	102540V	388	1060-27	322	1067-13	324	1081-19	341
1010PR.....	473	102507S1	388	102545S1	388	1060-28	322	1067-14	324	1081-20	341
1011MQ.....	392	102507S1.B	388	102545S1.B	388	1060-29	322	1067-15	324	1081-21	341
1014GPN.....	474	102507T	388	102545T	388	1060-30	322	1067-16	324	1081-22	341
1015GQ.....	495	102507T.B	388	102545T.B	388	1060-32	322	1067-17	324	1081-23	341
1015MQ.....	392	102507U	388	102550T	388	1060-55	322	1067-18	324	1081-24	341
1015PQ.....	392	102507U.B	388	102550T.B	388	1061-06	319	1067-19	324	1081-25	341
1016PR.....	473	102508H	388	102550S1	388	1061-07	319	1067-20	324	1081-26	341
1020-08.....	333	102508H.B	388	102555S1	388	1061-08	319	1067-21	324	1081-27	341
1020-09.....	333	102508M	388	102555S2	388	1061-09	319	1067-22	324	1081-28	341
1020-10.....	333	102508S1	388	102555S2.B	388	1061-10	319	1067-23	324	1081-29	341
1020-11.....	333	102508S1.B	388	102565S1	388	1061-11	319	1067-24	324	1081-30	341
1020-12.....	333	102508S2	388	102565S1.B	388	1061-12	319	1067-25	324	1081-32	341
1020-13.....	333	102508S2.B	388	1025PRN.....	473	1061-13	319	1067-26	324	1084-08	340
1020-14.....	333	102508T	388	1026CQ-AM	397	1061-14	319	1067-27	324	1084-09	340
1020-15.....	333	102508T.B	388	1031-10R	331	1061-15	319	1067-28	324	1084-10	340
1020-16.....	333	102508U	388	1031-11R	331	1061-16	319	1067-29	324	1084-11	340
1020-17.....	333	102508U.B	388	1031-12R	331	1061-17	319	1067-30	324	1084-12	340
1020-18.....	333	102508V	388	1031-13R	331	1061-18	319	1067-32	324	1084-13	340
1020-19.....	333	102509T	388	1031-14R	331	1061-19	319	1071-33	322	1084-14	340
1023EQ.....	392	102509T.B	388	1031-15R	331	1061-20	319	1071-34	322	1084-15	340
1025PRN.....	473	102509U	388	1031-16R	331	1061-21	319	1071-35	322	1084-16	340
102500P.....	388	102509U.B	388	1031-17R	331	1061-22	319	1071-36	322	1084-17	340
102500P.B	388	102509V	388	1031-18R	331	1061-23	319	1071-38	322	1084-18	340
102500R	389	102510H	388	1031-19R	331	1061-24	319	1071-41	322	1084-19	340
102500R.B	389	102510H.B	388	1031-22R	331	1061-25	319	1071-42	322	1090PR1	472
102501P	388	102510M	388	1031-24R	331	1061-26	319	1071-44	322	10A0-24	334
102501P.B	388	102510T	388	1031-26R	331	1061-27	319	1071-46	322	10A0-27	334
102501R	389	102510T.B	388	1031-27R	331	1061-28	319	1071-48	322	10A0-30	334
102501R.B	389	102510T-S1	398	1031-30R	331	1061-29	319	1071-50	322	10A0-32	334
102501Z	389	102510U	388	1031-32R	331	1061-30	319	1071-55	322	10A0-36	334
102501Z.B	381	102510U.B	388	1031-33R	331	1061-32	319	1071-60	322	10A0-41	334
102502P	388	102510V	388	1031-34R	331	1062-06	320	1071-65	322	10A0-46	334
102502P.B	388	102512P	388	1031-35R	331	1062-07	320	1071-70	322	10A0-50	334
102502P.S1	398	102512P.B	388	1031-36R	331	1062-08	320	1071-75	322	10A0-55	334
102502H	388	102515H	388	1031-38R	331	1062-09	320	1071-80	322	10A0-60	334
102502H.B	388	102515H.B	388	1031-41R	331	1062-10	320	1071-85	322	10A0-65	334
102502R	389	102515T	388	1031-46R	331	1062-11	320	1080-06	341	10A0-70	334
102502R.B	389	102515T.B	388	1031-48R	331	1062-12	320	1080-07	341	10A0-75	334
102502Z	389	102515T-S1	398	1031-50R	331	1062-13	320	1080-08	341	10A0-80	334
102502Z.B	389	102515U	388	1032CQ	398	1062-14	320	1080-09	341	10A0-85	334
102502Z-S1	398	102515U.B	388	1032CQ01	398	1062-15	320	1080-10	341	10A0-90	334
102503H	388	102515V	388	1035MR	408	1062-16	320	1080-11	341	10A0-95	334
102503H.B	388	102520T	388	1036MR	408	1062-17	320	1080-12	341	10A0-A0	334
102503P	388	102520T.B	388	1036ZQ	496	1062-18	320	1080-13	341	10A0-A5	334
102503P.B	388	102520T-S1	398	1040CQ	392	1062-19	320	1080-14	341	10A0-B0	334
102503R	389	102520U	388	1041CQ-EB	411	1062-20	320	1080-15	341	10A0-B5	334
102503R.B	389	102520U.B	388	1042CQ	392	1062-21	320	1080-16	341	10A0-C0	334
102503S1	388	102520V	388	1043CQ	392	1062-22	320	1080-17	341	10A0-C5	334
102503S1.B	388	102525H	388	1044CQ	393	1062-23	320	1080-18	341	10B0-24	334
102503Z	389	102525H.B	388	1045MR	409	1062-24	320	1080-19	341	10B0-26	334
102503Z.B	389	102525T	388	1045MR01-EB	410	1062-25	320	1080-20	341	10B0-27	334
102504H	388	102525T-S1	398	1048MR	394	1062-26	320	1080-21	341	10B0-30	334
102504H.B	388	102525U	388	1049CQ	409	1062-27	320	1080-22	341	10B0-32	334
102504M	388	102525U.B	388	1060-06	322	1062-28	320	1080-23	341	10B0-36	334
102504P	388	102527T	388	1060-07	322	1062-29	320	1080-24	341	10B0-41	334
102504P.B	388	102527T.B	388	1060-08	322	1062-30	320	1080-25	341	10B0-46	334
102504S1	388	102527U	388	1060-09	322	1062-32	320	1080-26	341	10B0-50	334
102504S1.B	388	102527U.B	388	1060-10	322	1063-06	324	1080-27	341	10B0-55	334
102504S2	388	102527V	388	1060-11	322	1063-08	324	1080-28	341	10B0-60	334
102504S2.B	388	102530T	388	1060-12	322	1063-11	324	1080-29	341	10B0-65	334
102505H	388	102530T.B	388	1060-13	322	1063-14	324	1080-30	341	10B0-70	334
102505H.B	388	102530T-S1	398	1060-14	322	1063-15	324	1080-32	341	10B0-75	334
102505M	388	102530U	388	1060-15	322	1063-16	324	1081-06	341	10B0-80	334
102505S1	388	102530U.B	388	1060-16	322	1063-18	324	1081-07	341	10B0-85	334
				1060-17	322	1063-21	324	1081-08	341	10B0-90	334
						1063-22	324	1081-09	341	10B0-95	334

Index

10B0-A0	334	10GOVE-11	429	112576	334	114503MR	412	115H12M-10	346	1207MR	323
10B0-A5	334	10GOVE-12	429	112605MR	413	114504MR	412	115H13M-10	346	1207SR	323
10B0-B0	334	10GOVE-13	429	112606MR	413	114505MR	412	115H13M-14	346	1208MR	323
10B0-B5	334	10GOVE-14	429	112608MR	413	114506MR	412	116002MR	420	1210MR	323
10B0-C0	334	10GOVE-15	429	112610MR	413	114507MR	412	116003MR	420	12107MRN	336
10B0B-24.....	N15	10GOVE-16	429	112612MR	413	114508MR	412	116004MR	420	12107MRN01.....	336
10B0B-26.....	N15	10GOVE-17	429	112710R	416	114510MR	412	116005MR	420	12109MRS01	321
10B0B-E18.....	N15	10GOVE-18	429	112715R	416	114515MR	412	116006MR	420	1211MR	323
10B0B-E20.....	N15	10GOVE-19	429	112720R	416	114525MR	412	116007MR	420	1211MRN	323
10B0B-E24.....	N15	10GOVE-21	429	112725R	416	114555MR	412	116008MR	420	1211SR	323
10C0-24	334	10GOVE-22	429	112727R	416	114605MR	413	116010MR	420	1211SR01	323
10C0-27	334	10GOVE-24	429	112730R	416	114606MR	413	116025MR	420	1211SR02	323
10C0-30	334	11 xxx		112740R	416	114608MR	413	116310R	420	12112MRN	336
10C0-32	334	110115SQ.....	N20	112745R	416	114610MR	413	116310TR	420	12112MRS02	321
10C0-36	334	1106MR	326	112750R	416	114612MR	413	116315TR	420	12114MRN	336
10C0-41	334	1106MR01	326	113002MR	414	114710R	416	116320TR	420	1212MR	323
10C0-46	334	1108MR	326	113002SR	414	114715R	416	116325TR	420	1212MR01	323
10C0-50	334	1108SR	326	113003MR	414	114720R	416	116327TR	420	1213SRN.....	323
10C0-55	334	111015Q	407	113003SR	414	114725R	416	116330TR	420	1214MR	323
10C0-60	334	11104PR	474	113004MR	414	114727R	416	116340TR	420	1214MR01	323
10C0-65	334	11104PR10	474	113004SR	414	114730R	416	116345TR	420	1214MRN	323
10D0-08	325	1110MR	326	113005MR	414	114740R	416	116350R	420	1214MRN05	323
10D0-09	325	1112MR	326	113005SR	414	114745R	416	116350TR.....	420	1214SR	323
10D0-10	325	1112MRN	326	113006MR	414	114750R	416	1163A05R	423	1214SRN01	323
10D0-11	325	1112SR	326	113006SR	414	115002MR	421	1163A06R	423	1215MR	323
10D0-12	325	111946	334	113007SR	414	115003MR	421	1163A07R	423	1215MR01	323
10D0-13	325	112002MR	414	113008MR	414	115004MR	421	1163A08R	423	1215MR02	323
10D0-14	325	112003MR	414	113008SR	414	115005MR	421	1163A09R	423	1215MRN01	323
10D0-15	325	112004MR	414	113010MR	414	115006MR	421	1163A10R	423	1215MRN02	323
10D0-16	325	112005MR	414	113010SR	414	115008MR	421	1163A15R	423	1216SR	323
10D0-17	325	112006MR	414	113012SR	414	115010MR	421	1163A20R	423	1216SRN	323
10D0-18	325	112007MR	414	113015MR	414	115025MR	421	116502MR	420	1218MR01	323
10D0-19	325	112008MR	414	113025MR	414	11509SQ05.....	475	116503MR	420	1218MRN	323
10F0-17P	325	112010MR	414	113025SR	414	11527SQ05.....	475	116504MR	420	12207SRN.....	337
10F0-19P	325	112015MR	414	11305SQ	571	115310R	422	116505MR	420	12208SR	321
10F0-21P	325	112025MR	414	113086	334	115315R	422	116506MR	420	122A06MR.....	N15
10F0-22P	325	11205SQ	489	11310SQ	489	115320R	422	116507MR	420	122A06MR01.....	N15
10F0-23P	325	11208SQ	489	11311MQ	496	115325R	422	116508MR	420	122A07MRN01.....	337
10F0-24P	325	11225SQ	490	11325SQ.....	497	115327R	422	116510MR	420	122A07MRN02.....	337
10F0-26P	325	112261	334	11328SQ.....	497	115330R	422	116525MR	420	122A09MRS01	321
10F0-27P	325	112310R	416	11406SQ	490	115340R	422	118406M	346	122A12MRN	337
10F0-29P	325	112315R	416	11409SQ02.....	475	115345R	422	118407M	346	122A12MRS02	321
10F0-30P	325	112320R	416	11409SQ03.....	475	115350R	422	118408M	346	122A14MRN	337
10F0-32P	325	112325R	416	11409SQ04.....	475	1153A05R	423	118409M	346	1224CRN	323
10F0-36P	325	112327R	416	11409SQ05.....	475	1153A06R	423	118410M	346	1226MR	323
10F0-38P	325	112330R	416	11409SQ06.....	475	1153A07R	423	118411M	346	1226MRN	323
10F0-41P	325	112340R	416	11409SQ08	475	1153A08R	423	118412M	346	1266MR	324
10F0-46P	325	112345R	416	11427SQ02.....	475	1153A09R	423	118413M	346	1272MR	324
10F0-50P	325	112350R	416	11427SQ03.....	475	1153A10R	423	118414M	346	1275MR	324
10F0-55P	325	112502MR	412	11427SQ04.....	475	1153A15R	423	118417M	346	1275MRN	324
10F0-60P	325	112502SR	412	11427SQ05	475	1153A20R	423	118508M	346	1282MR	325
10F0-65P	325	112503MR	412	11427SQ06	475	115502MR	421	118509M	346	12916MQ1	498
10F0-70P	325	112503SR	412	11427SQ08	475	115503MR	421	118510M	346	12939MQ1	498
10F0-75P	325	112504MR	412	114310R	416	115503SR	421	118511M	346	12939MQ-A	498
10FOVE-07.....	429	112504SR	412	114315R	416	115504MR	421	118512M	346	12939MQ-A03	498
10FOVE-08.....	429	112505MR	412	114320R	416	115504SR	421	118513M	346	12939SQ1	498
10FOVE-09.....	429	112505SR	412	114325R	416	115505MR	421	118514M	346	12939SQ-A	498
10FOVE-10.....	429	112506MR	412	114327R	416	115505SR	421	118517M	346	12939SQ-A03	498
10FOVE-11.....	429	112506SR	412	114330R	416	115506MR	421	118519M	346	1296MRN	323
10FOVE-12.....	429	112507MR	412	114340R	416	115506SR	421	119502M	423	12A0MRN	319
10FOVE-13.....	429	112508MR	412	114345R	416	115508MR	421	119503M	423	12A09MRS01	321
10FOVE-14.....	429	112508SR	412	114350R	416	115508SR	421	119504M	423	12A1MRN	319
10FOVE-15.....	429	112510MR	412	114502MR	412	115510MR	421	119505M	423	12A2MRS02	321
10FOVE-16.....	429	112510SR	412	114502SR	412	115510SR	421	119506M	423	12A3MRN	319
10FOVE-17.....	429	112512MR	412	114503SR	412	115512SR	421	119508M	423	12A4MRN	319
10FOVE-18.....	429	112512SR	412	114504SR	412	115525MR	421	119510M	423	12B4MRN	319
10FOVE-19.....	429	112514MR	412	114505SR	412	115525SR	421	119525M	423	12C7MRN01	319
10FOVE-20.....	429	112515MR	412	114506SR	412	115H05M-10	346	11A310R	422	12C8MRN	319
10FOVE-21.....	429	112516SR	412	114508SR	412	115H06M-10	346	11A315R	422	12D06MRS.....	321
10FOVE-22.....	429	112517MR	412	114510SR	412	115H07M-10	346	11A320R	422	12D06MRS01.....	N15
10FOVE-23.....	429	112518SR	412	114512SR	412	115H08M-10	346	11A325R	422	12D09MRN	320
10FOVE-24.....	429	112519MR	412	114516SR	412	115H08M-14	346	11A327R	422	12D09MRS01	321
10GOVE-07.....	429	112522MR	412	114518SR	412	115H09M-10	346	11A330R	422	12D10MRN	320
10GOVE-08.....	429	112525MR	412	114520SR	412	115H10M-10	346	11A340R	422	12D12MRS	321
10GOVE-09.....	429	112525SR	412	114524SR	412	115H10M-14	346	12 xxx		12D12MRS01.....	321
10GOVE-10.....	429			114525SR	412	115H11M-10	346			12D13MRN	320

Index

12D14MRN05.....	320	14126504-E*	380	14321503	439	14780204	431	15631618	346	168009H	390
12D15MRN.....	320	14126506	380	14321515	439	14780306	431	15631818	346	168009M	391
12D15MRN01.....	320	14126506-E*	380	14321803	439	147E0104.....	431	15632112	346	168010E	391
12D18MRN.....	320	14126514	380	14321815	439	147E0204.....	431	15632115	346	168010H	390
12D21MRN.....	320	14210023	376	14322003	439	14810103	382	15632118	346	168010M	391
12D26MRN	320	14210104	376	14322015	439	14810204	382	15661615	346	168010T	390
12D06MRS01.....	N15	14210112	376	14322503	439	14810204-E*	382	15661618	346	168010U	391
12FVE08MRN..	429	14210116	376	14322515	439	14810205	382	15661818	346	168012H	390
12FVE10MRN..	429	14210132	376	14323003	439	14810205-E*	382	15662115	346	168012M	391
13 xxx		14210204	376	14323015	439	14810306	382	157501P	403	168014M	391
13012MR	336	14210206	376	14323503	439	14810412	382	157502P	403	168015E	391
13013MR	336	14210212	376	14323515	439	14825503	383	157503P	403	168015T	390
1305SR.....	332	14210214	376	14324003	439	14826504	383	1586-09	571	168015U	391
1306MR	332	14210216	376	14324015	439	14826504-E*	383	1589262.....	207	168020E	391
1306MRN	332	14210306	376	14330403	439	14826505-E*	383	1589384.....	207	168020T	390
131101P	403	14220303	376	14330415	439	14826506	383	1596-09	571	168020U	391
131102P	403	14220404	376	14330503	439	14820806	383	16 xxx		168025E	391
131103P	403	14220503	376	14330515	439	14821012	383	1606MR	327	168025T	390
13113MR	336	14220504	376	14330603	439	14902JMR01.....	N16	1611MR	327	168025U	391
131501P	403	14220512	376	14330615	439	14A10132	379	163604H	390	168027E	391
131502P	403	14220516	376	14330703	439	14A10204	379	163605H	390	168027T	390
131503P	403	14220806	376	14330715	439	14A10214	379	163605M	391	168027U	391
1317012PN	386	14220807	376	14330803	439	14A10306	379	163606H	390	168030E	391
1317012ZN	386	14220808	376	14330815	439	14A20303	379	163606M	391	168030T	390
1317046SN	386	14221008	376	14330902	439	14A20404	379	163606M	391	168030U	391
1317057SN	386	14225503	376	14330903	439	14A20808	379	163607H	390	168040E	391
1317115TN	386	14225504	376	14331002	439	14A25504	379	163608H	390	168040T	390
1317225TN	386	14225505	376	14331003	439	14A25505	379	163608M	391	168040U	391
1317340TN	386	14225506	376	14331502	439	14A26506	379	163609H	390	168045E	391
1317401PN	386	14226504	376	14331503	439	14A26514	379	163609M	391	168045T	390
131744BHN	386	14226506	376	14332002	439	14A26514	379	163610E	391	168045U	391
1317501ZN	386	14226512	376	14332003	439	14A80132	379	163610H	390	168045U	391
131755BHN	386	14226514	376	1450-04	387	14A80204	379	163610M	391	168050E	391
1317602PN	386	14226516	376	1450-05	387	14B10103	382	163610T	390	168050T	390
131766BHN	386	14230602	377	1450-06	387	14B10204	382	163610U	391	168050U	391
1317702ZN	386	14230702	377	1450-07	387	14B10206	382	163612H	390	168055E	391
132A13MR	337	14230803	377	1450-08	387	14B10306	382	163612M	391	168055T	390
132A13MR01.....	N16	14230903	377	1450-09	387	14B20807	382	163614M	391	168055U	391
134501P	403	14231003	377	1450-10	387	14B25504	382	163615E	391	168060E	391
134502P	403	14231003	377	1450-11	387	14B26506	382	163615T	390	168060T	390
134503P	403	14231503	377	1450-12	387	15 xxx		163615U	391	168060U	391
1360012P	389	14231510	377	1450-13	387	15001012P	340	163620E	391	17 xxx	
1360022P	389	14232004	377	1450-14	387	15001113P	340	163620T	390	1706MR	328
1360023P	389	14232010	377	1450-45	387	15001214P	340	163620U	391	1707SR	328
1360023Z	389	14232504	377	1450-55	387	15001317P	340	163625E	391	1708MR	328
1360451Z	389	14232510	377	1453-05	387	15001415P	340	163625T	390	1708MR01	208
1360552P	389	14232704	377	1453-06	387	15001417P	340	163625U	391	1710MR	328
1360552Z	389	14233005	377	1453-07	387	15001719P	340	163627E	391	1712MR	328
1360703P	389	14233010	377	1453-08	387	15001721P	340	163627T	390	1712MRN	328
136501P	403	14234006	377	1453-10	387	15001921P	340	163627U	391	1712MRN01	328
136502P	403	14240206	377	14610103	381	15001922P	340	163630E	391	174010H	243
136503P	403	14270803	377	14610204	381	15001924P	340	163630T	390	174010H	253
13A6502P	403	14270903	377	14610206	381	15002123P	340	163630U	391	174012H	243
13B6502P	403	14271003	377	14610306	381	15002224P	340	163640E	391	174012H	253
14 xxx		14271503	377	14620806	381	15002326P	340	163640T	390	174014H	243
1406PR	332	14272004	377	14620807	381	15002427P	340	163640U	391	174014H	253
14103GP	288	14272504	377	14621008	381	15002430P	340	163645E	391	174017H	243
14108SRN	339	14272704	377	14621012	381	15002632P	340	163645T	390	174017H	253
14110003	380	14273005	377	14621210	381	15002730P	340	163645U	391	174019H	243
14110104	380	14274006	377	14622504	381	15002732P	340	163645U	391	174019H	253
14110204	380	14280023	377	14626504	381	15003032P	340	163650E	391	174022H	243
14110204-E*	380	14280104	377	14626506	381	15003236P	340	163650T	390	174022H	253
14110205-E*	380	14280132	377	14710003	431	15003368P	340	163650U	391	18 xxx	
14110206	380	14280204	377	14710104	431	15003641P	340	163655E	391	1805MR	341
14110206-E*	380	14280306	377	14710204	431	15003841P	340	163655U	391	1808MR	341
14110208-E*	380	14311003	439	14710306	431	151001P	403	163660E	391	1812MR	341
14110214	380	14311015	439	14720303	431	151002P	403	163660T	390	181202P	389
14110306	380	14311103	439	14720404	431	151003P	403	163660U	391	181203P	389
14110308	380	14311115	439	14720807	431	151501P	403	168004H	390	1826MR	389
14120303	380	14312003	439	14722503	431	151502P	403	168005H	390	183203H	389
14120404	380	14312015	439	14723504	431	151503P	403	168005M	391	183204H	389
14120806	380	14313003	439	14725505	431	155001P	403	168006H	390	183205H	389
14120808	380	14313015	439	14726506	431	155002P	403	168006M	391	183206H	389
14125504	380	14320615	439	14740105	431	155003P	403	168007H	390	183207H	389
14126504	380	14320815	439	14740206	431	15631612	346	168008H	390	183208H	389
		14321003	439	14780003	431	15631615	346	168008M	391		
		14321015	439	14780104	431						

Index

183212H	389	19001921	326	195427H	253	19992733	345	20109MW	415	203330	140
183215T	390	19001922	326	195427H	258	19992733A	345	20109MW-S	415	203340	140
183220T	390	19002022	326	195430H	253	19992833	345	20119MR01	414	203503	139
183225T	390	19002123	326	195430H	258	19992833A	345	20110MR	414	203504	139
183227T	390	19002224	326	195432H	253	19993032	345	201101X	138	203504S	139
183230T	390	19002326	326	195432H	258	19993032A	345	201102X	138	203505	139
183240T	390	19002426	326	19600607	327	19993233	345	201103X	138	203505S	139
183245T	390	19002427	326	19600809	327	19993233A	345	201104X	138	203506	139
183250T	390	19002430	326	19600810	327	19993238	345	201208X	138	203506S	139
183601P	389	19002528	326	19601011	327	19993238A	345	201235X	138	203507	139
183602P	389	19002632	326	19601012	327	19993821	345	201255X	138	203507S	139
183602Z	390	19002729	326	19601113	327	19993821A	345	201295R	414	203508	139
183603P	389	19002730	326	19601213	327	19993822	345	201308X	139	203508S	139
183603Z	390	19002732	326	19601214	327	19993822A	345	201309X	139	203510	139
183604H	389	19003032	326	19601415	327	19994121L	345	201310X	139	203510S	139
183604P	389	19003036	326	19601417	327	19994121LA	345	201315X	139	203512S	139
183604Z	390	19003236	326	19601617	327	19A00607	335	201320X	139	2035VE03	426
183605H	389	19003436	326	19601719	327	19A00809	335	201325X	139	2035VE04	426
183606H	389	19003641	326	19601819	327	19A01011	335	201327X	139	2035VE05	426
183607H	389	19004146	326	19601921	327	19A01213	335	201330X	139	2035VE06	426
183608H	389	19005507	326	19602022	327	19A01415	335	201340X	139	203708	140
183608S	389	19100607	333	19602123	327	19A01617	335	201503MX	138	203709	140
183609S	389	19100809	333	19602224	327	19A01819	335	201504MX	138	203710	140
183610H	389	19100810	333	19602326	327	19A02022	335	201505MX	138	203715	140
183610S	389	19101011	333	19602426	327	19A02123	335	201506MX	138	203720	140
183611S	389	19101012	333	19602427	327	19A02426	335	201506SX	138	203725	140
183612H	389	19101213	333	19602732	327	19A02528	335	201508MX	138	203727	140
183612S	389	19101214	333	19603032	327	19A02729	335	201508SX	138	203730	140
183614H	389	19101415	333	19611415	327	19A03032	335	201510MX	138	203740	140
183614S	389	19101417	333	19611617	327	19A0-09	335	201801X	139	203801	140
183620T	390	19101617	333	19611819	327	19A0-15	335	201802X	139	203802	140
183625T	390	19101719	333	19700607	328	19B00810	329	201803X	139	203803	140
183627T	390	19101819	333	19700809	328	19B01011	329	201804X	139	203A19PR	418
183630T	390	19101921	333	19700810	328	19B01012	329	2019MR	152	20407PR	417
183635T	390	19102022	333	19701011	328	19B01113	329	2019SR	414	20409PR	417
183640T	390	19102123	333	19701012	328	19B01214	329	201A09MR	418	20419PR	417
183645T	390	19102427	333	19701113	328	19B01315	329	201B09MR	418	2044SRV	157
183650T	390	1912MR	341	19701213	328	19B01417	329	20208MR	412	2048MRV	157
183655T	390	1912MRN	341	19701214	328	19B01618	329	20208MR01	413	204B29PR	418
183660T	390	19200608	332	19701314	328	19B01719	329	20208SR01	413	20505PR01	413
1842MR	340	19200711	332	19701415	328	19B01921	329	20209MR	412	20515PR01	413
187015T	390	19201012	332	19701417	328	19B02224	329	20209SR02	412	20A16MR	419
187020T	390	19201418	332	19701617	328	19C00607	329	2020H0MR	413	20A17MR	419
187025T	390	19201622	332	19701719	328	19C00809	329	2021MR	153	21 xxx		
187027T	390	19202024	332	19701819	328	19C01011	329	20210MR	413	2104PR	150
187030T	390	1926MR	341	19701921	328	19C01213	329	20218MR	412	2107PR	150
187040T	390	19300810	332	19701922	328	19C01415	329	20219MR	412	2109PR	150
187045T	390	19300911	332	19702022	328	19C01617	329	20219SR	412	21108MR	422
187050T	390	19301011	332	19702123	328	19C01819	329	2027MRE	153	2114TR	150
188002P	389	19301012	332	19702224	328	19C02022	329	2030CR	154	2119PR	150
188003P	389	19301113	332	19702326	328	19C02123	329	20307PR	417	21-20-07MR	481
188004P	389	19301213	332	19702426	328	19C02426	329	20308PR	417	21-20-101	481
188008S	389	19301214	332	19702427	328	19C02528	329	20309PR	417	21-20-102	481
188010S	389	19301315	332	19702528	328	19C03032	329	2031MR	154	21208MR	422
188012S	389	19301417	332	19703032	328	1A xxx			203101	139	21208SR	422
19 xxx			19301719	332	199104R	344	1A06MR	333	203102	139	2121-12	605
19000607	326	19301922	332	19911722	344	1B xxx			203103	139	2121-18	605
19000708	326	19312224	333	199306R	344	1B06MR	333	203104	139	2121A-15	605
19000809	326	19312427	333	19932433	344	1C xxx			20317MR	419	2121A-18	605
19000810	326	19313032	333	19932427	344	1C08MR	329	20318PR	417	2124-18	606
19000911	326	19500810	330	19961721	344	1C12MR	329	20319PR	417	2126A-18	606
19001011	326	19501012	330	19980016	345	1F xxx			20319PRU	417	2127-06M	489
19001012	326	19501113	330	19991921	345	1E xxx			203204	139	2127-08M	489
19001013	326	19501214	330	19991921A	345	1E10MR	331	203207	139	2127-11M	489
19001113	326	19501214	330	199920R	345	1E11MR	331	203208	139	2127-14M	489
19001213	326	19501315	330	19992224	345	20 xxx			203210	139	2127-18M	489
19001214	326	19501417	330	1999224A	345				203235	139	2127A-06M	489
19001214	326	19501618	330	19992427	345				203255	139	2127A-08M	489
19001314	326	19501719	330	19992427A	345				203265	139	2127A-11M	489
19001317	326	195404R	253	19992432	345				203308	140	2127A-14M	489
19001415	326	195419H	253	19992432A	345				203309	140	2127A-18M	489
19001417	326	195419H	258	199925R	345				203310	140	2127A-24M	489
19001617	326	195422H	253	19992730	345				203315	140	2127A-33M	489
19001618	326	195422H	258	19992730A	345				203320	140	2127A-50M	489
19001719	326	195424H	253	19992732	345				203325	140	2127PR	149
19001819	326	195424H	258	19992732A	345				203327	140			

Index

2127SR	149	227504M	138	2335VE06M.....	426	2551MR	155	302208	166	305208	235
2128-26	606	227505M	138	2335VE07M.....	426	2551MR01	155	302210	166	305210	235
2128PR	400	227506M	138	2335VE08M.....	426	2553MRV.....	157	302308	166	305255	235
2129-24	606	227507M	138	2335VE09M.....	426	2553MRV01	158	302309	166	305310	236
21-30-09MR	481	227508M	138	2335VE10M.....	426	2555MR	393	302310	166	305315	236
21309PR	422	2293-02	147	2335VE11M.....	426	2565MRV	156	302315	166	305320	236
213312DF	148	2293-03	147	2335VE12M.....	426	2571-45	149	302320	166	305325	236
2138PR	400	2293-04	147	2335VE13M.....	426	2575MR	155	302325	166	305327	236
2141	149	2293-06	147	2335VE14M.....	426	25VE01MRV.....	426	302327	166	305330	236
2142	149	23 xxx		237504M	138	27 xxx		302330	166	305340	236
2166DF	393	231008M	138	237505M	138	2725-55F	143	302340	166	305345	236
2176DF	148	231010M	138	237506M	138	2725-55G	143	302345	166	305350	236
2177DF	148	231010S	138	237507M	138	2725DK	143	302350	166	305355	236
2178DF	148	231012S	138	237508M	138	2745	146	3023MR	173	305360	236
2178TG	148	2311-06	147	237510M	138	2746.....	394	3023MRV11.....	175	3054MR	176
2178VE-05	426	2311-12	147	24 xxx		2747.....	146	3024MR	173	305504M	235
2179DF	148	2311-18	147	24110204	380	2747DR	146	3024SR	173	305505M	235
21A107	348	2311MR	149	24110214	380	2752-06G	143	302503	166	305504S.....	235
22 xxx		2312-06.....	147	24308PR	423	2752DK	143	302504	166	305505S	235
22106MR	421	2313MR	150	24311030	440	2752-45G	143	302505	166	305506M	235
22108MR	421	23208MR.....	422	24311140	440	2755-55G	143	302506	166	305506S	235
22118MR	421	233004M	137	24312020	440	2755DK	143	302507	166	305507M	235
22208MR	421	233005M	137	24330610	440	2760-04	145	302508	166	305507S	235
22218MR	421	233005S	137	24330715	440	2760DK01	145	302509	166	305508M	235
2221-02	147	233006M	137	24330820	440	2761-55F	143	302510	166	305508S	235
2221-03	147	233006S	137	24330915	440	2761-55P	143	302512	166	305510M	235
2221-04	147	233007M	137	2452-05F	148	2761DK	143	3025VE04	427	305510S	235
2221-06	147	233007S	137	2452DK	148	2769-55F	144	3025VE05	427	305512M	235
2221-10	147	233008M	137	2452DK	149	2769-55P	303	3025VE06	427	305512S	235
2221-12	147	233008S	137	2453-05F	149	2769DK	144	3025VE08	427	305514M	235
2221VE-04.....	426	233009M	137	25 xxx		276A-04G	145	3025VE10	427	305516M	235
2221VE-06.....	426	233009S	137	2501MR	146	276A-04G	145	302708	166	305516S	235
2223-02	147	233010M	137	2509MR	149	276ADK	145	302709	166	305517M	235
2223-04	147	233010S	137	2509SR	149	276B-0225	142	302710	166	305545S	235
22306TR	421	233010S	137	2510SR	150	2771-55F	144	302715	166	3055CR.....	175
22309TR	421	233011M	137	2511MR	150	2771-55G	144	302720	166	3055MR	432
223004M	138	233011S	137	2513MR	149	2771DK	144	302725	166	30605MR	432
223005M	138	233012M	137	2513MRD1	149	2771VE-55.....	426	302727	166	30606MR.....	432
223006M	138	233012S	137	2515MR	146	2773-55GS	141	302730	166	30607MR	432
223007M	138	233013M	137	2516MR	152	2773DK.....	144	302740	166	30607MR02	432
223008M	138	233013M	137	2516MRV03	155	2774-55F	144	302745	166	30615MR	432
223009M	138	233014M	137	2516SR	152	2774-55G	144	302745	166	30617MR	432
223010M	138	233014S	137	2518MR	152	2774DK	144	302750	166	306320	236
223011M	138	233015S	137	2518MR	152	2779-55F	144	3027MR	174	306325	236
223012M	138	233015S	137	2518MR	152	2779-55G	144	3027SR	174	306327	236
223013M	138	233016S	137	2518MR01	152	2779DK	144	302D08	166	306330	236
223014M	138	233016S	137	2518MR	152	2779DK	144	302D09	166	306340	236
223045M	138	233016S	137	2518MR	152	2781-06P	145	302D10	166	306345	236
223055M	138	233016S	137	2518MR	152	2781DK	145	302D15	166	306350	236
22319TR	421	233016S	137	2518MR	152	2789-06F.....	145	302D20	166	306355	236
223504M	137	233016S	137	2518MR	152	2789DK	145	302D25	166	306504M	235
223505M	137	233016S	137	2518MR	152	2792	147	302D27	166	306505M	235
223505S	137	233016S	137	2518MR	152	2793	148	302D30	166	306506M	235
223506M	137	233016S	137	2518MR	152	28 xxx		302D40	166	306508M	235
223506S	137	233016S	137	2518MR	152	2813.....	148	302D45	166	306510M	235
223507M	137	233016S	137	2518MR	152	2863P.....	234	302D50	166	30914AY	604
223507S	137	233016S	137	2518MR	152	30 xxx		302D55	166	30VE31MPV.....N12	
223508M	137	233016S	137	2518MR	152	30106AMRB	379	302D60	166	31 xxx	
223508S	137	233016S	137	2518MR	152	30107AMRB	379	30307PR	378	3103PR	172
223509M	137	233016S	137	2518MR	152	30115MR	378	30309PR	378	3105PR	171
223509S	137	233016S	137	2518MR	152	30116AMRB	379	30315PR	378	3106PR	170
223510M	137	233016S	137	2518MR	152	30117MR	378	30316PR	378	3108PR8	171
223510S	137	233016S	137	2518MR	152	30118MR	378	30317PR	378	3109PR8	171
223511M	137	233016S	137	2518MR	152	30127MR	378	30319PR	378	31107MR	378
223511S	137	233016S	137	2518MR	152	3013MR	170	3032SRV.....	175	31116MR	378
223512M	137	233016S	137	2518MR	152	3013SR	170	3033MRV.....	176	3113PR	172
223512S	137	233016S	137	2518MR	152	3020MR	173	3034MR	174	3116PR	170
223513M	137	233016S	137	2518MR	152	3020MR02	173	3036CR	174	3119PR8	171
223514M	137	233016S	137	2518MR	152	30206AMRB	382	303906	166	31216MR.....	378
223514S	137	233016S	137	2518MR	152	30206MR	381	303907	166	3121PR	171
223514S	137	233016S	137	2518MR	152	3020SR	173	303908	166	3129PR	170
223515M	137	233016S	137	2518MR	152	3020SR02	173	303909	166	3131PR8	171
223516S	137	233016S	137	2518MR	152	302102	166	303910	166	31416MR	384
223518S	137	233016S	137	2518MR	152	302103	166	305101	235	31419MR	441
223545M	131	233016S	137	2518MR	152	302104	166	305102	235	31427MR.....	385
223555M	137	233016S	137	2518MR	152	302205	166	305103	235	3146PR	171
		2335VE05M.....	426	2550MRV.....	158			305104	235		

Index

314708S 236	323021M 160	3311-12 169	3335VE09M 427	33672-160 275	34307-1A 309
314710M 236	323022M 160	33121 283	3335VE10M 427	33681-100 273	34323-1A 305
314710S 236	323022S 160	33122 283	3335VE11M 427	33681-101 273	34323-1B 305
314808S 170	323024M 160	333006M 159	3335VE12M 427	337504M 161	34323-1C 305
314810S 170	323024S 160	333007M 159	3335VE13M 427	337505M 161	34323-1DK1 305
314810M 170	323026S 160	333008M 159	3335VE14M 427	337506M 161	34323-2A 305
3149PR8 171	323028S 160	333008S 159	3335VE15M 427	337507M 161	34323-2B 305
31512MR 384	323030S 160	333009M 159	3335VE16M 427	337508M 161	34323-2C 305
31512MR01 384	323032S 160	333010M 159	3335VE17M 427	337510M 161	34323-2DK1 305
31516MR 384	32309PR 440	333010S 159	3335VE18M 427	337511M 161	3432F-1DK 304
31519MR 384	323506M 160	333011M 159	3335VE19M 427	337512M 161	3432F-1KF 304
3178VE-08 427	323507M 160	333011S 159	3335VE20M 427	337514M 161	3432F-3KF 305
32 xxx	323508M 160	333012M 159	3335VE21M 427	337516M 161	343506M 234
3203 343	323508S 160	333012S 159	3335VE22M 427	337518M 161	343507M 234
3203 554	323509M 160	333013M 159	3335VE24M 427	33811-150 276	343508M 234
320300 343	323510M 160	333014M 159	333E 161	33812-150 276	343508S 234
320300 554	323510S 160	333014S 159	333E10M 161	33831-180 276	343509M 234
320301 343	323511M 160	333015M 159	333E11M 161	33832-180 276	343510M 234
320301 554	323512M 160	333015S 159	333E12M 161	33841-180 274	343510S 234
3203A0 343	323512S 160	333016M 159	333E14M 161	33842-180 274	343511M 234
3203A0 554	323513M 160	333016S 159	333E16M 161	33851-120 274	343512M 234
3204 343	323514M 160	333017M 159	333E18M 161	33851-121 274	343512S 234
3204 554	323514S 160	333018M 159	333E20M 161	33851-250 278	343513M 234
320540 554	323515M 160	333018S 159	33411-040 271	33852-120 274	343514M 234
320560 554	323516M 160	333019M 159	33411-041 271	33852-121 274	343514S 234
3206A00 344	323516S 160	333019S 159	33411-050 271	33852-250 278	343515M 234
3206A00 554	323517M 160	333020M 159	33411-051 271	33861-200 277	343516M 234
32067A 344	323518M 160	333020S 159	33411-71 288	33862-200 277	343516S 234
32067A 554	323518S 160	333021M 159	33412-050 271	33871-160 275	343517M 234
320760 554	323519M 160	333022M 159	33412-051 271	33872-160 275	343518M 234
3209-120 N18	323520S 160	333022S 159	33421-040 271	33911-250 278	343518S 234
3209-135 N18	323521M 160	333023M 159	33421-041 271	33912-250 278	343519M 234
3209-220 N18	323522M 160	333024M 159	33431-050 270	33921-300 278	343520M 234
32108MR 440	323522S 160	333024S 159	33431-051 270	33922-300 278	343520S 234
32118MR 440	323524M 160	333026S 159	33431-065 272	34 xxx	343521M 234
3213MR 172	323524S 160	333028S 159	33461-100 268	34011 310	343522M 234
3214-35 485	323526S 160	333030S 159	33461-101 268	34011-1DG 310	343522S 234
3214-60 485	323528S 160	333032S 159	33481-095 273	34011-2DG 310	343523M 234
321510M 159	323530S 160	333506M 159	33481-096 273	34011-IEG 310	343524M 234
321512M 159	323532S 160	333507M 159	33491-030 269	34011-2EG 310	343524S 234
32209MR 440	3235VE08M 427	333508M 159	33491-031 269	3406MP 237	343526S 234
32218MR 440	3235VE10M 427	333508S 159	335008M 164	34102-040M 582	343528S 234
3221-03 169	3235VE12M 427	333509M 159	335009M 164	3419PP 237	34362-1CG 293
3221-06 169	3235VE14M 427	333510M 159	335010M 164	34207-1A 309	34362-1DG 293
3221-10 169	32518MR 386	333510S 159	335011M 164	34211-3DG 310	34362-1DK 293
3221-16 169	32518MR01 387	333511M 159	335012M 164	34223-1A 305	34362-1DK 303
3221-18 169	32518MR02 387	333511S 159	335013M 164	34223-1B 305	34362-1GG 293
3221-24 169	32526MRN 395	333512M 159	335014M 164	34223-1C 305	34362-2CG 303
3221VE-06 427	32540MR 396	333512S 159	335015M 164	34223-1DK1 305	34362-2DG 293
3221VE-10 427	3260-03P 236	333513M 159	335016M 164	34262-1CG 293	34362-2DK 293
3223-02 169	3260-04P 236	333514M 159	335017M 164	34262-1DG 293	34362-2GG 293
3223-03 169	3260-05P 236	333514S 159	335018M 164	34262-1DK 293	34362-3DG 293
3223-06 169	3260-06P 236	333515M 159	335019M 164	34262-1GG 293	34367-2AG 308
3223-10 169	3260-08P 236	333515S 159	335108M 164	34262-2DG 303	34367-2DK 308
3223-14 169	3260-10P 236	333516M 159	335109M 164	34262-3DG 293	3436A-1DK 298
323007M 160	32607MR 440	333516S 159	335110M 164	34266-1FG 303	3436A-1DK01 298
323008M 160	327504M 161	333517M 159	335111M 164	34366-1FG 303	3436A-1DK02 298
323008S 160	327505M 161	333518M 159	335112M 164	34466-1FG 303	3436A-2DG 296
323009M 160	327506M 161	333518S 159	335113M 164	34466-2FG 303	3436A-2DK 298
323010M 160	327507M 161	333519M 159	335114M 164	34466-3FG 303	3436A-2DK02 298
323010S 160	327508M 161	333519S 159	335115M 164	34666-1DK 303	3436A-2EG 296
323011M 160	327510M 161	333520M 159	335116M 164	34666-1FG 303	3436C-1DF 295
323012M 160	327511M 161	333520S 159	335117M 164	34666-3DK 303	3436C-1DK 295
323012S 160	327512M 161	333521M 159	335118M 164	34666-3FG 303	3436C-2DF 295
323013M 160	327514M 161	333522M 159	335119M 164	3426A-1DG 296	3436E-1DK 302
323014M 160	327516M 161	333522S 159	33611-055 272	3426A-1DK02 296	3436E-1HG 302
323014S 160	327518M 161	333523M 159	33611-056 272	3426A-1DK02 298	3436E-2HG 302
323015M 160	32808MR 395	333524M 159	33621-075 272	3426A-1EG 296	3436E-3HG 302
323016M 160	32809MR 393	333524S 159	33621-076 272	3426A-2DG 296	34407-1A 309
323016S 160	3293-03 169	333526S 159	33622-075 272	3426A-2EG 296	34407T-1A 309
323017M 160	3293-06 169	333528S 159	33622-076 272	3426C-1DF 295	34417-1A 307
323018M 160	3293-10 169	333530S 159	33631-110 273	3426C-1DK 295	34423-1A 305
323018S 160	33 xxx	333532S 159	33631-111 273	3426C-2DF 295	34423-1B 305
323019M 160	33108MR 378	3335VE06M 427	33632-110 273	3426E-1DK 302	34423-1C 305
323020S 160	3311-06 169	3335VE07M 427	33632-111 273	3426E-1HG 302	34423-1DK1 305
		3335VE08M 427	33671-160 275		34423-2A 305

Index

34423-2B	305	34501127M	298	34502216M	300	34522-9DG	297	3520MR	173	363521	163
34423-2C	305	34501130M	298	34502216S	300	3452407MR	300	3520MR02	173	3641-35	343
34423-3DK	305	34501132M	298	34502217M	300	3452DK	169	35208MR	381	3641-50	343
344251A12MR	305	34501136M	298	34502218M	300	3453-08F	169	3523MR	173	3641-80	343
3442F-1DK	304	34501213M	299	34502218S	300	3453DK	169	3523MRV10	175	3641-C0	343
3442F-1KF	304	34501214M	299	34502219M	300	34607-1A	310	3523MRV11	175	3641-I0	343
3442F-3KF	304	34501215M	299	34502220S	300	3465G-1FB	306	3524MR	173	365014B	162
34440	311	34501216M	299	34502221M	300	3465G-2FB	306	3527MR	174	365016A	162
34440A	311	34501216S	299	34502222M	300	3465G-3FB	306	3533MRV	176	365016B	162
3445G-1FB	306	34501217M	299	34502224M	300	34660	311	3534MR	174	366021	163
34462-1CG	293	34501218M	299	34502224S	300	34660A	311	353506M	234	366516	163
34462-1DG	293	34501218S	299	34502227M	300	34662-1CG	293	353507M	234	366521	163
34462-1DK	293	34501219M	299	34502230M	300	34662-1DG	293	353508M	234	367018	163
34462-1DK	303	34501220S	299	34502232M	300	34662-1DK	293	353508S	234	367021	163
34462-1EG	293	34501221M	299	34502234M	300	34662-1GG	293	353509M	234	367514	163
34462-1GG	293	34501222M	299	34502236M	300	34662-2CG	293	353510M	234	367516	163
34462-2CG	293	34501222S	299	34502241M	300	34662-2DG	293	353510S	234	367518	163
34462-2DG	293	34501223M	299	34503102R	298	34662-2FG	293	353511M	234	367521	162
34462-3DG	293	34501224M	299	34503103R	298	34662-2GG	293	353512M	234	36A014	162
34462-3DK	293	34501224S	299	34503104R	298	34662-3CG	293	353512S	234	36B014	162
34462-3DK	303	34501225M	299	34503203R	298	34662-3DG	293	353513M	234	36B018	162
34462-4DG	293	34501226M	299	34503204R	298	34662-3DK1	293	353514M	234	36B514	162
34462-2FG	293	34501226S	299	34503206R	298	34662-4EG	293	353514S	234	36C014	162
34462-2GG	293	34501227M	299	34504236M	300	34662-3GG	293	353515M	234	36D014	162
34462-3GG	293	34501228S	299	34504245M	300	34666-1DK	303	353516M	234		
34464-1DK	304	34501230M	299	34504255M	300	34666-1FG	303	353516S	234		
34464-1FG	304	34501230S	299	34504262M	300	34666-2DG	303	353517M	234		
34464-2FG	304	34501232M	299	34504275M	300	34666-3FG	303	353518M	234		
34467-1AG	308	34501232S	299	34504290M	300	3466A-1DK	298	353518S	234		
34467-1DK	308	34501234M	299	34505102R	300	3466A-1DK01	298	353519M	234		
3446A-1DG	296	34501236M	299	34505201R	300	3466E-1DK	302	353520S	234		
3446A-1DK	298	34501236S	299	34510	301	3466E-1HG	302	353522S	234		
3446A-1DK02	296	34501238M	299	345101E08MR	301	3466E-2HG	302	353524S	234		
3446A-1DK03	296	34501240M	299	345102D08MR	301	34688	311	3537MR	174		
3446A-1DK	298	34501240S	299	345102E08MR	301	34688-05A	311	3545MRV	176		
3446A-1DK02	298	34501241M	299	345104D08MR	301	34688-P01	311	3568MR	177		
3446A-1EG	296	34501248S	299	34512-1CG	297	34688-P02	311	3571-08	169		
3446A-2DG	296	34501410M	299	34512-1DG	297	34688-P03	311	357505M	235		
3446A-2EG	296	34501411M	299	34512-1EG	297	3485G-1DB	306	357506M	235		
3446E-1DK	302	34501412M	299	34512-1FG	297	3485G-2DB	306	357507M	235		
3446E-1HG	302	34501413M	299	34512-2CG	297	34862-1CG	293	357508M	235		
3446E-2HG	302	34501414M	299	34512-2DG	297	34862-1DG	293	357510M	235		
3446E-3HG	302	34501416M	299	34512-2EG	297	34862-1EG	293	357512M	235		
34486	311	34501417M	299	34512-2FG	297	34862-1GG	293	357514M	235		
34486-05A	311	34501418M	299	34512-3CG	297	34862-2CF	294	35VE01MRV	427		
34486-P03	311	34501419M	299	34512-3DG	297	34862-2CG	294				
34488	311	34501421M	299	34512-3EG	297	34862-2DF	294				
34488-05A	311	34501422M	299	34512-3FG	297	34862-2DG	294				
34488-26	312	34502107M	299	34512-4DG	297	34862-2DK	293				
34488-26DK	312	34502108M	299	3452-08F	169	34862-2DK	294				
34488-P03	311	34502108S	299	3452-10F	169	34862-2EF	294				
34501107M	298	34502110M	299	34520DK	301	34862-2EG	294				
34501108M	298	34502110S	299	345201D11MR	301	34862-2FF	294				
34501108S	298	34502111M	299	345201E11MR	301	34862-1FG	294				
34501109M	298	34502112M	299	345202C11MR	301	34862-2FG	294				
34501110M	298	34502112S	299	345202D11MR	301	34862-2GG	294				
34501110S	298	34502113M	299	345202E11MR	301	34862-3CF	295				
34501111M	298	34502114M	299	345203D11MR	301	34862-3DK	295				
34501112M	298	34502114S	299	345203E11MR	301	34862-3DK90	295				
34501112S	298	34502115M	299	34522-1CG	297	34862-3DK91	295				
34501113M	298	34502116M	299	34522-1DG	297	34862-3DK92	295				
34501114M	298	34502116S	299	34522-1EG	297	34862-3FF	295				
34501114S	298	34502117M	299	34522-1FG	297	3488A03MP	313				
34501115M	298	34502118M	299	34522-2CG	297						
34501116M	298	34502118S	299	34522-2DG	297						
34501116S	298	34502119M	299	34522-2EG	297						
34501117M	298	34502120S	299	34522-2FG	297						
34501118M	298	34502121M	299	34522-3CG	297						
34501118S	298	34502122M	299	34522-3DG	297						
34501119M	298	34502122S	299	34522-3EG	297						
34501120S	298	34502124S	299	34522-3FG	297						
34501121M	298	34502126S	299	34522-4DG	297						
34501122M	298	34502128S	299	34522-5DG	297						
34501122S	298	34502213M	300	34522-6DG	297						
34501124M	298	34502214M	300	34522-7DG	297						
34501124S	298	34502215M	300	34522-8DG	297						

37 xxx

3709MR10	165
3716MR	163
372110S	339
372111M	339
372112M	339
372112S	339
372114S	339
372115M	339
372116M	339
372116S	339
372118M	339
372118S	339
372120S	339
372122S	339
372124S	339
37221-030	283
37221-031	283
37235-030	284
37235-031	284
3725-08F	167
3725-08G	167
3725DK	167
373008M	335
373009M	335
373010M	335
373011M	335
373012M	335
373013M	335
373014M	335
373015M	335
373016M	335
373017M	335
373018M	335
373019M	335
373021M	335
373022M	335
373024M	335
37308M	336
373109M	336
373110M	336
373111M	336
373112M	336
373113M	336
373114M	336
373115M	336
373116M	336
373117M	336
373118M	336
373119M	336
373121M	336

36 xxx

3609MR10	164
3611-06P	342
3611-06R	342
3611-08P	342
3611-08R	342
3611-10P	342
3611-10R	342
3611-12P	342
3611-12R	342
3611-15HP	342
3611-15HR	342
3611-18HP	342
3611-18HR	342
3611-24HP	342
3611VE-06	429
3611VE-08	429
3611VE-10	429
3611VE-12	429
3612MR	164
3614-08R	342
3616-10	343
3616S-08P	343
3616S-14P	343
3619MR10	164
36206MR	383
363016	163
363021	163
3631-10R	342
363516	163

35 xxxx

3508MR	172
3508MR10	170
3508SR	172
35105MR	380
35107MR	380
3511-06	348
3511-10	348
35114MR	383
35114MR01	383
35116MR01	380
3513MR	170

Index

373122M	336	375014M	165	401413M	180	4026MR	200	404605	183	4072SR	179
373124M	336	375014S	165	401414M	180	4026MR03	200	404607	183	407505M	243
373127M	336	375015M	165	401419M	180	4026MR04	200	404608	183	407506M	243
373130M	336	375016M	165	401505M	242	4026SR	200	404610	183	407508M	243
373132M	336	375016S	165	401506M	242	4026SR03	200	404612	183	407510M	243
373202H	339	375017M	165	401507M	242	402720	184	404614	183	407512M	243
373202R	339	375018M	165	401508M	242	402725	184	4047MR	203	407514M	243
373203R	339	375018S	165	401508S	242	402727	184	404904	184	409616M	243
373204R	339	375019M	165	401509M	242	402730	184	404905	184	40D006	183
373210S	337	375020S	165	401510M	242	402740	184	404906	184	40D008	183
373212S	337	375022S	165	401510S	242	402745	184	404907	184	40D010	183
373214S	337	375024S	165	401512M	242	402750	184	404908	184	40D506	183
373216S	337	3752-09G	167	401512S	242	402755	184	404909	184	40D508	183
373218S	337	3752DK	167	401513M	242	402760	184	404910	184	40D510	183
373220S	337	3755-08G	167	401514M	242	4028MR	199	404912	184	41 xxx	
373222S	337	3755DK	167	401516S	242	4028SR	199	404913	184	41026MR	108
373224S	337	3760-45	167	401517M	242	402A10	184	404914	184	41026MRD	108
373228S	337	3760DK01	167	401519M	242	402B16	184	404916	184	4104PR	190
373230S	337	3761-08F	167	40165R	197	402B18	184	404925	184	4105PR	194
37321-050	283	3761-08P	167	402102	183	4030CR	201	405320	242	4106PR	193
37321-051	283	3769-08F	168	402103	183	4030CR01	201	405325	242	4108FR	204
373225H	339	3769-08P	168	402104	183	4031MR	198	405327	242	4108PR10	194
37323-080	284	3769DK	168	402208	183	4031SR	198	405330	242	4109PR	196
37323-081	284	3771-08G	168	402210	183	4032MR	199	405340	242	4109PR10	194
37334-080	283	3771DK	168	402212	183	4032SR	199	405345	242	4110PR	196
37334-081	283	3771VE-08	427	402214	183	403320	184	405350	242	4110PR10	193
37335-030	284	3774-08G	168	402216	183	403325	184	405355	242	4110SR10	193
37360809M	338	3774DK	168	402320	184	403327	184	405360	242	4111FR	204
37361011M	338	3779-08F	168	402325	184	403330	184	405370	242	4112FR	204
37361013M	338	3779-08G	168	402327	184	403340	184	405504M	242	4116FR01	204
37361213M	338	3779DK	168	402330	184	403345	184	405505M	242	4116PR	194
37361415M	338	3781-11F	168	402340	184	403350	184	405506M	242	4117PR	196
37361618M	338	3781-11P	168	402345	184	403355	184	405506S	242	4118MR	193
37361719M	338	3781DK	168	402350	184	403360	184	405507M	242	4119PR	196
37370607M	338	378508M	163	402355	184	403370	184	405508M	242	4119PR10	194
37370809M	338	378509M	163	402360	184	4033MR	198	405508S	242	4120PR	196
37371011M	338	378510M	163	402370	184	4033MR03	201	405510M	242	4120PR10	194
37371213M	338	378512M	163	4024MR	198	4033SR	198	405510S	242	4121-11GR	190
37371415M	338	378514M	163	4024SR	198	4034MR	201	405512M	242	4126PR	194
37371618M	338	378516M	163	4025VE04	428	4034MR06	201	405512S	242	4128PR	196
37372123M	338	3792	170	4025VE05	428	403504	183	405513M	242	4136PR	194
37372224M	338	3794	170	4025VE06	428	403505	183	405514M	242	414708S	243
373811M	338	3795-18	348	4025VE08	428	403506	183	405514S	242	414710M	243
373812M	338	3795-24	348	4025VE10	428	403507	183	405516M	242	414710S	243
373813M	338	3795-30	348	402503	183	403508	183	405516S	242	414808S	243
373814M	338	3796P	236	402504	183	403509	183	405517M	242	414810M	243
373815M	338	38 xxx		402505	183	403510	183	405518M	242	414810S	243
3739J0813M	N16	3812	170	402506	183	403511	183	405519M	242	4148PR10	181
3739J1619M	N16	3814	170	402506S	183	403512	183	405608M	242	414A08S	243
373A07M	337	3814	570	402507	183	403514	183	405610M	242	41526MR	108
373A08M	337	3862P	236	402507S	183	403517	183	405612M	242	41526MRD	102
373A09M	337	3864P	236	402508	183	403519	183	40603GP	430	41517MRV	109
373A10M	337	3893EW	169	402508S	183	4035VE04	428	406325	242	41517MRVD	109
373A11M	337	3893EW-01	169	402509	183	4035VE05	428	406327	242	41542MRV	109
373A12M	337	3893EW-01	169	402509S	183	4035VE06	428	406330	242	41542MRVD	109
373A13M	337	3893EW-02	147	402510	183	4035VE08	428	406340	242	4178VE-08	428
373A14M	337	3893EW-02	169	402510S	183	4035VE10	428	406345	242	42 xxx	
373A15M	337	39 xxx		402511	183	403605	183	406350	242	4208MR	195
373A16M	337	39122008M	497	402512	183	403606	183	406355	242	4208MR10	193
373A17M	337	39123010M	497	402512S	183	403608	183	406360	242	4208SR	195
373A18M	337	39123012M	497	402514	183	403610	183	406504M	243	42104GP	359
373A19M	337	39124012M	497	402514S	183	403612	183	406505M	243	42104GP01	359
373A21M	337	3E xxx		402516S	183	403614	183	406506M	243	42107GX	463
373A22M	337	3E07PR	171	402517	183	403720	184	406508M	243	42114GP	360
373A24M	337	40 xxx		402518S	183	403725	184	406510M	243	42116GP	360
37423-080	284	4010MR	193	402519	183	403727	184	406512M	243	4213MR	195
37423-081	284	4010SR	193	402520S	183	403730	184	406514M	243	42124GP	359
37434-080	283	4012MR	197	402524S	183	403740	184	406608	183	42124GP01	359
37434-081	283	4012SR	197	402605	183	403745	184	406609	183	42124GP04	359
37435-075	284	401408M	180	402606	183	403750	184	406610	183	4215MR	195
37435-076	284	401409M	180	402608	183	403755	184	406612	183	42154GP	195
375010M	165	401410M	180	402610	183	403760	184	406614	183	4216MR	195
375011M	165	401411M	180	402612	183	404108	184	406616	183	4220MR	197
375012M	165	401412M	180	402614	183	4042CR	202	4066MR	181	4221-18	190
375012S	165			402616	183	4042CR02	202	4066SR	181	4221-24	190
375013M	165			402618	183	4044CR	202	4072MR	179		

Index

4221-30	190	423524M	180	4293-02	190	433509MR	178	437508M	181	443510M	239
4221-36	190	423524S	180	4293-05	190	433510MR	178	437510M	181	443510S	239
42213GP01	359	423525M	180	4293-10	190	433510SR	178	437511M	181	443511M	239
4223-02R	190	423526M	180	43 xxx		433511MR	178	437512M	181	443512M	239
4223-05R	190	423526S	180	4306MRN	204	433512MR	178	437514M	181	443512S	239
4223-10R	190	423527M	180	4308MR	195	433512SR	178	437516M	181	443513M	239
4223MR	197	423528M	180	4308MR10	193	433513MR	178	437518M	181	443514M	239
4224MR	199	423528S	180	4311-16F	190	433514MR	178	437520M	181	443514S	239
423008M	179	423529M	180	4311-16G	190	433514SR	178	437522M	181	443515M	239
423009M	179	423530M	180	4311MR	193	433515MR	178	437524M	181	443516M	239
423010M	179	423530S	180	4313MR01	195	433515SR	178	44 xxx		443516S	239
423010S	179	423532M	180	4315MR	195	433516MR	178	4405MXL	248	443517M	239
423011M	179	423532S	180	4316MR	195	433516SR	178	4407MP	249	443518M	239
423012M	179	423533M	180	4320MR	197	433517MR	178	4408MP	246	443518S	239
423012S	179	423534M	180	4324MR	199	433518MR	178	4408SP	246	443519M	239
423013M	179	423534S	180	43240115Y	604	433518SR	178	4410MP	247	443520M	239
423014M	179	423536M	180	4325MR	200	433519MR	178	4410MP01	247	443520S	239
423014S	179	423536S	180	43250115Y	604	433519SR	178	4410SP	247	443521M	239
423015M	179	423538M	180	43260115Y	604	433520MR	178	44106AMP01 ...	280	443522M	239
423016M	179	423538S	180	43270115Y	604	433520SR	178	44108AMP01 ...	280	443522S	239
423016S	179	423540S	180	43290115Y	604	433521MR	178	44116MP	279	443523M	239
423017M	179	423541M	180	43280212	603	433522MR	178	44118MP	279	443524M	239
423018M	179	423542S	180	432A0113	605	433522SR	178	44116MP04	279	443524S	239
423018S	179	423544S	180	432A0213	605	433523MR	178	44116MP10	279	443525M	239
423019M	179	423546S	180	433008MR	178	433524MR	178	44118MP	279	443526M	239
423020M	179	423548S	180	433009MR	178	433524SR	178	44118MP04	279	443526S	239
423020S	179	424508M	180	433010MR	178	433525MR	178	44118MP10	279	443527M	239
423021M	179	424509M	180	433010SR	178	433525SR	178	4412MP	246	443528M	239
423022M	179	424510M	180	433011MR	178	433526MR	178	4413MP	247	443528S	239
423022S	179	424512M	180	433011MR	178	433526SR	178	4414MP	246	443529M	239
423023M	179	424513M	180	433012MR	178	433527MR	178	4414SP	246	443530M	239
423024M	179	424514M	180	433012SR	178	433528MR	178	441517M	241	443530S	239
423024S	179	42503PR	361	433013MR	178	433528SR	178	441519M	241	443532M	239
423025M	179	42504PR	361	433013SR	178	433529MR	178	441521M	241	443532S	239
423026M	179	4251-02R	190	433014MR	178	433530MR	178	441522M	241	443533M	239
423026S	179	4251-03R	190	433014SR	178	433530SR	178	4415MP	247	443534M	239
423027M	179	4251-04R	190	433015MR	178	433533MR	178	4415MP03	247	443534S	240
423028M	179	4251-05R	190	433015SR	178	433533SR	178	4416SP	247	443536M	239
423028S	179	4251-06R	190	433016MR	178	433533MR	178	4417PP	249	443536S	240
423029M	179	4251-08R	190	433016SR	178	433534MR	178	4418MP	249	443538M	239
423030M	179	4251-10R	190	433016SR	178	433534SR	178	4419MP	247	443538S	240
423030S	179	4251VE-05	428	433017MR	178	433534SR	178	4421MP01.....N14		443540S	240
423032M	179	4251VE-10	428	433018MR	178	433536MR	178	4423MP	246	443541M	239
423032S	179	425508M	180	433018SR	178	433536SR	178	443008M	239	443541M	239
423033M	179	425508M	180	433019MR	178	433538MR	178	443009M	239	443542S	240
423034M	179	425509M	180	433019SR	178	433538SR	178	443010M	239	443546M	239
423034S	179	425510M	180	433020MR	178	433539MR	178	4452-15FR	190	4452-18FR	190
423036M	179	425512M	180	433020SR	178	433540SR	178	443012M	239	4452-24FR	190
423036S	179	425513M	180	433021MR	178	433541MR	178	443013M	239	4452DK	190
423038S	179	425514M	180	433022MR	178	433546MR	178	443014M	239	4452DK1	190
423040S	179	4260-03P	243	433022SR	178	4335VE08M	428	443015M	239	4453-15F	190
423508M	180	4260-04P	243	433023MR	178	4335VE10M	428	443016M	239	4453-18F	190
423509M	180	4260-05P	243	433024MR	178	4335VE11M	428	443017M	239	4457MP	249
423510M	180	4260-06P	243	433024SR	178	4335VE12M	428	443018M	239	4461-24G	191
423510S	180	4260-08P	243	433025MR	178	4335VE13M	428	443019M	239	4462-18F	190
423511M	180	4260-10P	243	433025SR	178	4335VE14M	428	443020M	239	4462-24F	191
423512M	180	4260-12P	243	433026MR	178	4335VE15M	428	443020S	239	4462DK	191
423512S	180	4260-16P	243	433026SR	178	4335VE16M	428	443021M	239	4466MP	240
423513M	180	4269-08-90	244	433027MR	178	4335VE17M	428	443022M	239	4466MP-A	240
423514M	180	4269-08-A0	244	433028MR	178	4335VE18M	428	443023M	239	4466MP-DA	240
423514S	180	4269-08-B0	244	433028SR	178	4335VE19M	428	443024M	239	4466MP-DB	240
423515M	180	4269-08-C0	244	433029MR	178	4335VE20M	428	443024S	239	4466SP	240
423516M	180	4269-08-D5	244	433030MR	178	4335VE21M	428	443027M	239	4466SP-A	240
423516S	180	4269-08-F0	244	433030SR	178	4335VE22M	428	443028S	239	4466SP-D	240
423517M	180	4269-08-G0	244	433032MR	178	4335VE24M	428	443030M	239	4467PP	249
423518M	180	4269-08-H5	244	433032SR	178	4335VE27M	428	443030S	239	4472MP	238
423518S	180	4269-08-J0	244	433033MR	178	4335VE30M	428	443032M	239	4472MP-A	238
423519M	180	4269-08-K0	244	433034MR	178	4335VE32M	428	443032S	239	4472MP-D	238
4251VE-05	428	427508M	181	433034SR	178	433E	181	443034S	239	4472SP	238
4251VE-10	428	427510M	181	433036MR	178	433E18M	181	443036M	239	4472SP-A	238
423520M	180	427512M	181	433036SR	178	433E20M	181	443036S	239	4472SP-D	238
423520S	180	427514M	181	433038MR	178	433E22M	181	443040S	239	4476MP	249
423521M	180	427516M	181	433038SR	178	433E24M	181	443042S	239	44801AMP	281
423522M	180	427518M	181	433040MR	178	433E26M	181	443048S	239	44801AMP01	281
423522S	180	427520M	181	433044SR	178	433E28M	181	443508M	239	44801BMP	281
423523M	180	427522M	181	433045MR	178	433E30M	181	443509M	239	44801FMP	281
		427524M	181	433506MR	178	433E32M	181				
				433507MR	178						
				433508MR	178						

Index

44801FMP01 281	453018S 237	453534S 238	4760-05 186	493009M 240	4B5522S 243
44802AMP 281	453019M 237	453535M 238	4760-05G 186	493010M 240	4B5526S 243
44802BMP 281	453020M 237	453536M 238	4760DK01 186	493011M 240	4B5528S 243
44802FMP 281	453020S 237	453536S 238	4762-10F 186	493012M 240	4B5530S 243
44803AMP 282	453021M 237	453537M 238	4762-10G 186	493013M 240	4E xxx	
44803BMP 282	453022M 237	453538M 238	4762-10P 186	493014M 240	4E08PR N17
44803FMP 282	453022S 237	453538S 238	4762-15G 186	493015M 240	50 xxx	
4481PP1 244	453023M 237	453539M 238	4762DK 186	493016M 240	5022MR 213
44904MP 248	453024M 237	453540S 238	4768-10F 186	493017M 240	5022SR 213
44904MP01 N13	453024S 237	453541M 238	4768-10G 186	493018M 240	502503H 388
44904MP02 N13	453025M 237	453546M 238	4768-10P 186	493019M 240	502503H.B 388
44905MP 248	453026M 237	4535MR 202	4768-15F 186	493020M 240	502504H 388
44906MP 248	453026S 237	4542CR 202	4768-15G 186	493021M 240	502504H.B 388
44907MP N13	453027M 237	4542CR02 202	4768DK 186	493022M 240	502505H 388
44K732M 230	453028M 237	4544CR 202	4771-10BR 186	493023M 240	502505H.B 388
44K738M 230	453028S 237	4547MR 203	4771-10FR 186	493024M 240	502506H 388
44K745M 230	453029M 237	4566MR 181	4771-10GR 186	493027M 240	502506H.B 388
44K752M 230	453030M 237	4572-10 191	4771DK 186	493030M 240	502506H.B 388
44K758M 230	453030S 237	4572-12 191	4771VE-10 428	493032M 240	502507H 388
44K832M 230	453032M 237	4572DK 191	4772-10F 187	493036M 240	502507H.B 388
44K838M 230	453032S 237	4572MR 179	4772DK01 187	493510M 240	502508H 388
44K845M 230	453033M 237	4572SR 179	4773-10GS 188	493510S 241	502508H.B 388
44K852M 230	453034M 237	4573-10R 191	4773-22GS 189	493511M 240	502509H 388
44K858M 230	453034S 237	4573DK 191	4773DK 188	493512M 240	502509H.B 388
44K928M 229	453036M 237	457510M 242	4774-10F 187	493512S 241	502510H 388
44K932M 229	453036S 237	457512M 242	4774-10G 187	493513M 240	502510H.B 388
44K938M 229	453038M 237	457514M 242	4774DK 187	493514M 240	5039CR 213
45 xxx		453038S 237	457516M 242	4779-10BR 187	493514S 241	5060-08 322
4501MR 196	453041M 237	457518M 242	4779-10FR 187	493516M 241	5060-10 322
4503MR01 345	4531MR 198	457520M 242	4779-10GR 187	493516S 241	5060-12 322
4505MR 204	4531SR 198	4581-10 191	4779DK01 187	493517M 241	5060-14 322
4505SR 204	4532MR 199	4583-12R 191	4781-12F 187	493517M 241	5060-16 322
4506MR 345	4532SR 199	4584-12R 191	4781DK 187	493518S 241	5060-18 322
4510MR 193	4533MR 198	45VE01MRV 428	4791R 192	493519M 241	5060-20 322
4510SR 193	4533MR03 201	46 xxx		4793 192	493520S 241	5060-22 322
4511-06 348	4533SR 198	463014RC 182	4794 192	493521M 241	5060-24 322
4511-10 348	4534MR 201	463014RC 570	4795-18 348	493522M 241	5060-26 322
45115PP 608	4534MR06 201	463016RC 182	4795-36 348	493522S 241	5060-28 322
4511MR 196	453508M 238	463021RC 182	4796P 245	493523M 241	5060-30 322
4511SR 196	453509M 238	463021R 570	4797P 245	493524M 241	5060-32 322
4512MR 197	453510M 238	463514RC 182	4798P 245	493524S 241	5060-34 322
4512SR 197	453510S 238	463514RC 570	4799P 245	493526M 241	5060-36 322
4516MR 197	453511M 238	463516RC 182	48 xxx		493526S 241	5060-40 322
4516SR 197	453512M 238	463516R 570	4813 191	493527M 241	5063-14 324
45211PP 608	453512S 238	463521R 570	4815MP04 248	493528S 241	5063-16 324
4523MRV01 203	453513M 238	466016 182	4815MP05 248	493530M 241	5063-18 324
4524MR 198	453514M 238	466016 570	4816 191	493532S 241	5071-42 322
4524MRV04 203	453514S 238	466021 182	48280180 603	493534S 241	5071-44 322
4524SR 198	453515M 238	466021 570	483510M 240	493536S 241	5071-46 322
452513M 238	453516M 238	466516C 182	483511M 240	493538S 241	5071-48 322
452514M 238	453516S 238	466516 570	483512M 240	493540S 241	5071-50 322
452517M 238	453517M 238	466521C 182	483513M 240	494515M 241	5071-52 322
452519M 238	453518M 238	466521 570	483514M 240	494517M 241	5071-54 322
452521M 238	453518S 238	467014C 182	483516M 240	494519M 241	5071-56 322
452522M 238	453519M 238	467016 182	483517M 240	494521M 241	5071-58 322
452524M 238	453520M 238	467021 182	483517M 240	494522M 241	5071-60 322
4526MR 200	453520S 238	467514C 182	483519M 240	49517MX 241	5071-62 322
4526MR03 200	453521M 238	467516 182	483521M 240	49519MX 241	5071-64 322
4526MR15 203	453522M 238	467521 182	483522M 240	495521MX 241	5084-16 322
4526SR 200	453522S 238	47 xxx		483523M 240	495521MX 241	5084-18 222
4526SR03 200	453523M 238	4724-01 373	483524M 240	4B xxx		51 xxx	
4528MR 199	453524M 238	4724-11G 373	483526M 240	4B5510M 243	5169PR 393
4528SR 199	453524S 238	4724DK 373	483527M 240	4B5511M 243	54 xxx	
453008M 237	453525M 238	4725-10FR 185	483530M 240	4B5512M 243	5450-08 387
453009M 237	453526M 238	4725-10GR 185	483535M 240	4B5512S 243	5450-10 387
453010M 237	453526S 238	4725-12BR 185	4844R 192	4B5513M 243	55 xxx	
453011M 237	453527M 238	4725-12FR 185	4863P 245	4B5514M 243	5522MR 213
453012M 237	453528M 238	4725-12GR 185	4866P 245	4B5514S 243	57 xxx	
453013M 237	453528S 238	4725DKR01 185	4873P 245	4B5515M 243	572210M 347
453014M 237	453529M 238	4752-12G 186	49 xxx		4B5516M 243	572212M 347
453015M 237	453530M 238	4752DK 186	49151719M 241	4B5516S 243	574208M 347
453016M 237	453530S 238	4755-10G 185	49151921M 241	4B5517M 243	574212M 347
453016S 237	453532M 238	4755DK 185	49152122M 241	4B5518S 243	574213M 347
453017M 237	453532S 238	4756-10G 185	49152123M 241	4B5520S 243	574214M 347
453018M 237	453533M 238	4756DK 185	49152426S 241	4B5521M 243		
		453534M 238			493008M 240	4B5522M 243		

Index

575208M 347	601514M 253	6217-05 436	63 xxx	633084S 205	6424MP.....N14
575210M 347	601517M 253	6224CR 209	6311-06 354	633086S 205	6431-10C 355
575212M 347	601519M 253	6226CR 210	6311-08 354	633088S 205	6431-11C 355
575213M 347	601521M 253	623030M 206	6313-06 354	6331-06 355	643519M 251
575214M 347	601522M 253	623032M 206	6314-05 354	6331-08 355	643521M 251
575217M 347	601524M 253	623033M 206	6314MR 209	6334-05 354	643522M 251
576208M 347	601527M 253	623036M 206	6314MR12 210	633517M 206	643523M 251
576210M 347	601530M 253	623039M 206	6315-06 361	633518M 206	643524M 251
576213M 347	601532M 253	623041M 206	6315-09 361	633519M 206	643524S 251
576214M 347	6016MR 209	623046M 206	6316MR 209	633520M 206	643525M 251
576217M 347	6016SR 209	623050M 206	6317-06 437	633521M 206	643526M 251
577406M 347	602360 207	6231-07 353	6318-08A 430	633522M 206	643526S 251
577407M 347	602370 207	6232-08 353	6319-11C 354	633523M 206	643527M 251
577408M 347	602380 207	623517M 206	6323MR 209	633524M 206	643528M 251
577409M 347	602390 207	623518M 206	6329-13C 354	633525M 206	643528S 251
577410M 347	6023A0 207	623519M 206	633017M 205	633526M 206	643529M 251
577411M 347	6023MR 209	623520M 206	633019M 205	633527M 206	643530M 251
577412M 347	6023SR 209	623521M 206	633021M 205	633528M 206	643530S 251
577413M 347	602514 207	623522M 206	633022M 205	633529M 206	643532M 251
577414M 347	602517 207	623523M 206	633022S 205	633530M 206	643532S 251
577415M 347	602519 207	623524M 206	633023M 205	633531M 206	643533M 251
577416M 347	602522 207	623525M 206	633024M 205	633532M 206	643534M 251
577417M 347	6031-07 360	623526M 206	633024S 205	633533M 206	643534S 251
577418M 347	6031-07R 360	623527M 206	633026M 205	633534M 206	643535M 251
577419M 347	6031-10 360	623528M 206	633026S 205	633535M 206	643536M 251
59 xxx	6031-10R 360	623529M 206	633027M 205	633536M 206	643536S 251
59000810 326	609616M 253	623530M 206	633028M 205	633537M 206	643538M 251
59001012 326	609616M10H 253	623531M 206	633028S 205	633538M 206	643538S 251
59001214 326	609616M12H 253	623532M 206	633029M 205	633539M 206	643540M 251
59001416 326	609616M14H 253	623533M 206	633030M 205	633540M 206	643540S 251
59001618 326	609616M17H 253	623534M 206	633030S 205	633541M 206	643541M 251
59001820 326	609616M19H 253	623535M 206	633032M 205	633542M 206	643542M 251
59002022 326	609616M22H 253	623536M 206	633032S 205	633543M 206	643542S 251
59002224 326	609622M 253	623537M 206	633033M 205	633544M 206	643543M 251
59002628 326	609622M19H 253	623538M 206	633034M 205	633545M 206	643544M 251
59003032 326	609622M22H 253	623539M 206	633034S 205	633546M 206	643544S 251
59003034 326	609622M24H 253	623540M 206	633035M 205	633547M 206	643546M 251
59003236 326	609622M27H 253	623541M 206	633036M 205	633548M 206	643546S 251
59003640 326	609622M30H 253	623542M 206	633036S 205	633549M 206	643548M 251
59301012 332	609622M32H 253	623543M 206	633038M 205	633550M 206	643548S 251
59301214 332	61 xxx	623544M 206	633038S 205	633551M 206	643550M 251
59301618 332	6111-06 353	623545M 206	633040S 205	633552M 206	643550S 251
59301820 332	6111-07 353	623546M 206	633041M 205	633553M 206	643552S 251
59302224 332	6111-08 353	623547M 206	633042M 205	633554M 206	643554S 251
59302428 332	6112-09 353	623548M 206	633042S 205	633555M 206	643555M 251
59601214 327	6114-05 353	623549M 206	633044S 205	633556M 206	643556S 251
59601618 327	6116-07A 430	623550M 206	633046M 205	633557M 206	643558S 251
59602022 327	6116-08A 430	623551M 206	633046S 205	633558M 206	643560M 251
59602428 327	6121-06X 362	623552M 206	633048M 205	633559M 206	643560S 251
59603032 327	6121-09X 362	623553M 206	633048S 205	633560M 206	643562S 251
59700810 328	6131-12 356	623554M 206	633050M 205	633562M 206	643564S 251
59701012 328	6131-12P01 356	623555M 206	633054M 205	633563M 206	643565M 251
59701214 328	6131-14 356	623556M 206	633055M 205	633564M 206	6452-18F 207
59701416 328	6131-14P01 356	623557M 206	633050S 205	633565M 206	6452-30F 207
59701618 328	6131-18 356	623558M 206	633052S 205	633570M 206	6452DK 207
59701820 328	6131-18P01 356	623559M 206	633054S 205	6336-08A 430	6462-40P 207
59702022 328	6131-24 356	623560M 206	633056S 205	6337-06 437	6462DK 207
59702224 328	6131-24P01 356	623563M 206	633058M 205	6339-13C 354	6463-08C 355
59702428 328	6131-30 356	623565M 206	633058S 205	6347-05 438	647518M 252
59702628 328	6131-30P01 356	623570M 206	633060M 205	6377-55 437	647520M 252
59703032 328	6131-36 356	6236-07A 430	633060S 205	63A7-05 438	647522M 252
59703436 328	6131-36P01 356	6247-05 436	633062S 205	63B7-05 438	647524M 252
59703640 328	6131-42 356	6251-04 207	633063M 205	64 xxx	64801AMP 282
59703842 328	6131-42P01 356	6251-08 207	633064S 205	6408MP 255	64801BMP 282
60 xxx	6133-08 356	6251-16 207	633065M 205	6408MP10 255	64801FMP 282
6011-05R 360	6141-06C 456	6260-04 254	633066S 205	6482-24G 208	6482DK 208
6011-07 360	6141-08C 456	6260-04P 254	633068S 205	6409MP 255	64K765M 230
6011-07R 360	6146-08A 430	6260-07 254	633070M 205	6409MP03 255	64K770M 230
6011-10 360	62 xxx	6260-07P 254	633070S 205	6409SP10 255	64K775M 230
6011-10R 360	6207-05 436	6260-10 254	633072S 205	6410MP 255	64K780M 230
6012-07 360	6211-06 353	6260-10P 254	633074S 205	6410SP 255	64K865M 230
6012-10 360	6213-06 353	6260-13 254	633076S 205	6411-06 355	64K870M 230
6013-10R 360	6214-05 353	6260-13P 254	633078S 205	64114FMP 282	64K875M 230
6014MR 209	6214-45 353	6271-05C 437	633080S 205	6411AMP 282	64K880M 230
6014MR12 210	6216-06A 430	6271-65C 437	633082S 205	6411MP 254	64K975M 229

Index

65 xxx

651017M	249
651018M	249
651019M	249
651021M	249
651022M	249
651023M	249
651024M	249
651026M	249
651027M	249
651028M	249
651029M	249
651030M	249
6511-10	356
6511-10C	356
6511-13C	356
6511-17C	356
651417M	252
651419M	252
651420M	252
651421M	252
651514M	250
651515M	250
651516M	250
651517M	250
651518M	250
651519M	250
651521M	250
651522M	250
651523M	250
651524M	250
651525M	250
651526M	250
651527M	250
651528M	250
651529M	250
651530M	250
6516-10	355
6516-10A	430
6516-10C	355
6517-08C	355
6517-10C	355
6517-12C	355
6518-10C	357
6521-13	369
6521-16	369
6521-21	369
6521-26	369
6522	N18
6522-12	N18
6522-16	N18
6522-22	N18
6522-25	N18
6522-29	N18
653017M	250
653019M	250
653021M	250
653022M	250
653023M	250
653024M	250
653026M	250
653027M	250
653028M	250
653029M	250
653030M	250
653032M	250
653033M	250
653034M	250
653035M	250
653036M	250
653038M	250
653040M	250
653041M	250
653042M	250
653046M	250

653063M	250
653065M	250
653070M	250
6531-10	369
6531-12	369
6531-14	369
6531-18	369
6531-24	369
6531-36	369
6531-48	369
6532-08	370
6532-10	370
6532-12	370
6532-14	370
6532-18	370
6532-24	370
6532-36	370
6532-48	370
6533-10L	370
6533-12L	370
6533-14L	370
6533-18L	370
6533-24L	370
6533-36L	370
6533-48L	370
653513M	250
653517M	250
653518M	250
653519M	250
653521M	250
653522M	250
653522S	251
653523M	250
653524M	250
653524S	251
653526M	250
653526S	251
653527M	250
653528M	250
653528S	251
653529M	250
653530M	250
653530S	251
653531M	250
653532M	250
653532S	251
653533M	250
653533S	251
653534M	250
653534S	251
653535M	250
653536M	250
653536S	251
653538M	250
653538S	251
653540M	250
653540S	251
653541M	250
653542M	250
653542S	251
653543M	250
653544M	250
653544S	251
653545M	250
653546M	250
653546S	251
653548M	250
653548S	251
653550M	250
653550S	251
653552M	250
653552S	251
653554M	250
653554S	251
653555M	250
653556S	251
653557M	250

653558M	250
653558S	251
653560M	250
653560S	251
653562S	251
653563M	250
653564S	251
653565M	250
653566S	251
653568S	251
653570M	250
653570S	251
653572S	251
653574S	251
653576S	251
6572-20	208
6572DK	208
657524M	252
657526M	252
657528M	252
657530M	252
657532M	252
6581-12	208
6581-18	208
6585-19	208
65SS-07	359

66 xxx

6605-08	361
6615-06	362
6615-11	362
6615-18	362
6625-06	362
6625-11	362
6625-18	362
6655-09	361
6665-09	361
66SB-07	358
66SS-07	358
66HB-07	358
66HS-07	358

67 xxx

6711-06	355
6716-06A	430
6721-10	465
6724-20F	207
6724DK	207
6732-09	465
6741-06	465
6751-44	459
6755-05	460
6756-05	460
6761-07	459
6762-08	459
6778-20FS	207
6778DK	207
6779-20F	207
6779DK	207
6781-85	463
6781P0A	463
6781P0B	463
6781P0C	463
6781P0D	463
6781P0F	463
6781P0H	463
6791	208
6797P	253
6798P	253
67A1-07	459
67B1-06	460
67B2-05	461
67B3-55	461
6BB11	439
6BC141-1	441
6BC141A	441
67F1-08	463

67G	464
67G0005	463
67G1-09	464
67G1P01	464
67GB-09	464
67GBP01	464
67GG-09	464
67GH-09	464
67GHP01	463
67GHP01	464
67GJ-09	464
67GJP01	463
67GJP01	464
67GK-09	464
67GKP01	463
67GKP01	464
67GL-09	464
67GLP01	464
67GLP01	463
67GN-09	463
67GN-09	464
67GNP01	463
67GNP01	464
67HB-07	358
67HS-07	358
67SB-07	358
67SS-07	359

68 xxx

6814	208
6818	208
683517M	252
683519M	252
683521M	252
683522M	252
683523M	252
683524M	252
683526M	252
683527M	252
683529M	252
683530M	252
683532M	252
6864	254
6864P	254
6868	254
6868P	254
6874	254
6874P	254
68GB-01	608
68GB-02	608
68GR-01	608
68GS-11	608
68GS-16	608
68GQ-01	608
68GQ-02	608
68HB-05	358
68HB-07	358
68HB-07L	359
68HB-10	358
68HS-05	358
68HS-07	358
68HS-10	358
68RB-01	608
68RR-01	608
68RS-11	608
68RS-16	608
68RQ-01	608
68SB-05	358
68SB-07	358
68SB-10	358
68SS-05	358
68SS-07	358
68SS-10	358
68ZZ-01	608
68ZZ-02	608

69 xxx

6921-05	353
6921-05C	353
6921-06	353
6921-06C	353
6921-07	353
6921-07C	353
6927-05	436
693519M	252
693521M	252
693522M	252
693523M	252
693524M	252
693524S	252
693526M	252
693526S	252
693527M	252
693528S	252
693529M	252
693530M	252
693530S	252
693532M	252
693532S	252
693534S	252
693536S	252
693538S	252
693540S	252

6921-05	353
6921-05C	353
6921-06	353
6921-06C	353
6921-07	353
6921-07C	353
6927-05	436
693519M	252
693521M	252
693522M	252
693523M	252
693524M	252
693524S	252
693526M	252
693526S	252
693527M	252
693528S	252
693529M	252
693530M	252
693530S	252
693532M	252
693532S	252
693534S	252
693536S	252
693538S	252
693540S	252

6A xxx

6AB12-55	453
6AB13-06	453
6AB14-06	454
6AB14-65	454
6AB21-65	453
6AB31-75	453
6AB33-95	455
6AC51-26	466
6AC52-12	466
6AD10-325	456
6AD10-3P01	456
6AD16-500	456
6AD17-150	456
6AD23-400	456
6AF11-125	443
6AF21-165	443
6AG11-20	444
6AH01-1	444
6AH01-2	444
6AH01-3	444
6AH01-4	444
6AH11	444
6AH12	444
6AH13	444
6AH14	444

6B xxx

6BB11	488
6BC100	443
6BC200	443
6BC141-1	441
6BC141A	441
6BC200	443
6BC210A	441
6BC210B	441
6BC210C	441
6BC210D	441
6BC210F	442
6BC23-1	442
6BC23A	441
6BC23B	441
6BC23F	441
6BC24A	441
6BC24B	441
6BC24C	441
6BC24F	441
6BC26-1	442
6BC26-3	442
6BC26A	441

6BC26B	441
6BC26C	441
6BC26F	441
6BC3007	442
6BC372	442
6BC372-1	442
6BC372-2	442
6BC372-3	442
6BC372-4	442
6BC372-5	442
6BD11	442
6BD22	442
6BE11-07	443
6BE12-07	443
6BE16-07	443
6BF11-17	442
6BF21-17	442
6BJ21	488
6BJ901	488

6C xxx

6CB02	450
6CB21	450
6CB31	448
6CB41	449

70 xxx

7003MR	222
7010MR	223
7011MR	216
7028MR	224
7053MR01	225
7077MR	218
7081MR	219
7082MR	217
7087MR	220
7096MR	215
7098MR	221

71 xxx

711002P	399
711002P-S1	401
711102H	399
711102H-S1	401
711103H	399
711103H-S1	401
711104H	399
711104H-S1	401
711105H	399
711105H-S1	401
711106H	399
711106H-S1	401
711107H	399
711107H-S1	401
711108H	399
711110H	399
711110T	399
711110T-S1	401
711110U	400
711110U-S1	402
711115T	399
711115T-S1	401
711115U	400
711115U-S1	402
711120T	399
711120T-S1	401
711120U	400
711120	

Index

711127U-S1 402	715003P-S1 401	715055S1-S1 401	719002P-S1 401	74A00..... 485	76104-05 471
711130T 399	715003R 400	715065S1 399	719002Z 400	75 xxx	76104-74G 473
711130T-S1 401	715003R-S1 402	715065S1-S1 401	719002Z-S1 402	750-100 403	76105-06 471
711130U 400	715003S1 399	716502P 399	719003P 399	750-150 403	76106-74G 473
711130U-S1 402	715003S1-S1 401	716502P-S1 401	719003P-S1 401	750-50A 403	76108-74G 473
711140T 399	715003Z 400	717000R 400	719003Z 400	750-60 403	7611006M 405
711140T-S1 401	715003Z-S1 402	717000R-S1 402	719003Z-S1 402	750-75 403	7611008M 405
711140U 400	715004H 399	717001P 399	72 xxx	75035-06..... 496	76110-74G 473
711140U-S1 402	715004H-S1 401	717001P-S1 401	721102P 400	7503MR 222	7611010M 405
7112PR 212	715004S1 399	717001R 400	721102P-S1 402	751-60 403	7611012M 405
7113PR 212	715004S1-S1 401	717001R-S1 402	726502P 400	751-75 403	7611013M 405
711501P 399	715004S2 399	717001Z 400	726502P-S1 402	75101-08G 495	7611014M 405
711501P-S1 399	715004S2-S1 401	717001Z-S1 402	727502P 400	75101-10G 495	7611506M 405
711502H 401	715005H 399	717002H 399	727502P-S1 402	75102-08G 495	7611507M 405
711502P 399	715005H-S1 401	717002P 399	73 xxx	75102-10G 495	7611508M 405
711502P-S1 399	715005S1 399	717002P-S1 401	731101P 400	7510MR 223	7611510M 405
711503H 401	715005S1-S1 401	717002R 400	731101P-S1 402	7511MR 216	7611512M 405
711503P 399	715006H 399	717002R-S1 402	731102P 400	75135-06..... 496	7611513M 405
711503P-S1 399	715006H-S1 401	717002Z 400	731102P-S1 402	752-100 404	7611514M 405
711504H 401	715006S1 399	717002Z-S1 402	731103P 400	752-150 404	7612006M 405
711505H 399	715006S1-S1 401	717003H 399	731103P-S1 402	752-300 404	7612008M 405
711505H-S1 401	715006T 399	717003P 399	731103P-S1 402	752-60 404	7612010M 405
711506H 399	715006T-S1 401	717003P-S1 401	731152P 403	752-75 404	7612012M 405
711506T 401	715007H 399	717003R 400	731502P 400	75201-08G 495	7612014M 405
711506T-S1 399	715007H-S1 401	717003R-S1 402	731502P-S1 402	75201-10G 495	76125-74G 473
711507H 399	715007T 399	717003Z 400	731503P 400	75202-08G 495	7614208S 405
711507H-S1 401	715007T-S1 401	717003Z-S1 402	731503P-S1 402	75202-10G 495	7614210S 405
711507T 399	715008H 399	717004H 400	731552P 403	75235-06..... 496	7614512S 405
711507T-S1 401	715008H-S1 401	717005H 402	734501P 400	7528MR 224	7616505M 405
711508H 399	715008T 399	717005H-S1 402	734501P-S1 402	7528MR01 224	7616506M 405
711508T 401	715008T-S1 401	717006H 399	734502P 400	75302-08G 495	7616507M 405
711508T-S1 401	715009T 399	717006H-S1 399	734502P-S1 402	75302-10G 495	7616508M 405
711509T 399	715009T-S1 401	717006T 399	734503P 400	753-63 404	7616508S 405
711509T-S1 401	715009U 400	717006T-S1 401	734503P-S1 402	75335-06..... 496	7616510M 405
711510T 399	715009U-S1 402	717007H 399	734551P 403	754-90 404	7616510S 405
711510T-S1 401	715010T 399	717007T 401	734552P 403	75402-08G 495	7616512M 405
711512SH-S1 399	715010T-S1 401	717007T-S1 399	736501P 400	75402-10G 495	7616513M 405
711515T 401	715010U 400	717008H 399	736501P-S1 402	75435-06..... 496	7616512S 405
711515T-S1 399	715010U-S1 402	717008T 399	736502P 400	755-300 404	7616514M 405
711520T 401	715012SH 399	717008T-S1 399	736502P-S1 402	755-400 404	7616514S 405
711520T-S1 399	715012SH-S1 401	717009T 399	736503P 400	75501-08G 495	76210-10 472
711525T 401	715014SH 399	717009T-S1 401	736503P-S1 402	75501-10G 495	76213-04 472
711525T-S1 399	715014SH-S1 401	717010T 399	736552P 403	75502-08G 495	76213-06 472
711527T 401	715015T 399	717010T-S1 401	74 xxx	75502-10G 495	76215-05 472
711527T-S1 212	715015T-S1 401	717010U 400	74010 493	75535-06..... 496	76217-06 472
711530T 212	715015U 400	717010U-S1 402	74020 493	7553MR01 225	76218-75G 473
711530T-S1 399	715015U-S1 402	717011T 399	74030 493	7558MR 213	76219-75G 473
711540T 401	715020T 399	717015T-S1 401	74040 493	7577MR 218	76220-84G 473
711540T-S1 400	715020T-S1 401	717015U 400	74060 493	7581MR 219	76222-84G 473
7120PR 402	715020U 400	717015U-S1 402	741002P 400	7581MR01 219	76220-07 472
7120PR01 399	715020U-S1 402	717020T 399	741002P-S1 402	7582MR 217	76223-08 472
715000P 401	715025H 399	717020T-S1 401	7411PP 246	7587MR 220	76224-10 472
715000P-S1 399	715025H-S1 401	717020U 400	741502P 400	7587MR01 220	76226-12 472
715001P 399	715025T 399	717020U-S1 402	741502P-S1 402	7587SR 220	76301-05 471
715001P-S1 401	715025T-S1 401	717025H 399	742002P 400	7596MR 215	76302-05 471
715002P 399	715025U 400	717025T 399	74250 493	7598MR 221	76302-74G 473
715002P-S1 401	715025U-S1 402	717025T-S1 401	74260 493	759-140 404	76303-05 471
715003P 399	715027T 399	717025U 400	74270 493	75A105M 405	76303-74G 473
715003P-S1 401	715027T-S1 401	717025U-S1 402	743002P 400	75A106M 405	76304-05 471
715004P 399	715027U 400	717027T 399	743003P 400	75A108M 405	76304-74G 473
715004P-S1 401	715027U-S1 402	717027T-S1 401	74410 494	75A110M 405	76305-05 471
715000R 400	715030T 399	717027U 400	74412 494	75A112M 405	76305-74G 473
715000R-S1 402	715030T-S1 401	717027U-S1 402	74414 494	75A114M 405	76306-05 471
715001R 400	715030U 400	717030T 399	74416 494	75A116M 405	76306-74G 473
715001R-S1 402	715030U-S1 402	717030T-S1 401	745002P 400	75RF09M.....N16	76307-05 471
715001Z 400	715035S1 399	717030U 400	745002P-S1 402	76 xxx	76308-05 471
715001Z-S1 402	715035S1-S1 401	717030U-S1 402	74512 494	7601012M 405	76308-74G 473
715002H 399	715040T 399	717040T 399	74514 494	7601013M 405	76309-06 471
715002H-S1 401	715040T-S1 401	717040T-S1 401	74613 494	7605512M 405	76310-06 471
715002R 400	715040U 400	717040U 400	747501P 400	7606512M 405	76402-45 472
715002R-S1 402	715040U-S1 402	717040U-S1 402	747501P-S1 402	7606508S 405	76402-55G 473
715002Z 400	715045S1 399	719001P 399	747502P 400	7606510S 405	76403-05 472
715002Z-S1 402	715045S1-S1 401	719001P-S1 401	747502P-S1 402	7606512M 405	76403-06 472
715003H 399	715050T 399	719001Z 400	747503P 400	7606512S 405	76403-06G 473
715003H-S1 401	715050T-S1 401	719001Z-S1 402	747503P-S1 402	7607510M 405	76404-06 472
715003P 399	715055S1 399	719002P 399		76103-04 471	76404-07G 473

Index

76405-65	472	7822-30	470	7915A-19	368	79962-15	286	801536M.....	N14	843538S	257
76405-08G	473	7822-40	470	7915A-28	368	79962-20	286	80155R	212	843540M	257
76406-07	472	7822-45	470	7916-0111	368	79982-06	285	809622M	258	843540S	257
76406-84G	473	7822-50	470	7916-12M	368	79982-10	285	809622M19H ...	258	843541M	257
76407-84G	473	7823-10	470	7916-15M	368	799A0-23C	287	809622M22H ...	258	843542M	257
76408-08	472	7823-15	470	7916-21M	368	799A0-33C	287	809622M24H ...	258	843542S	257
76408-88G	473	7823-20	470	7918-A0	366	799A0-43C	287	809622M27H ...	258	843544S	257
76409-88G	473	7833-10	470	7918-A011	366	799A1-23C	287	809622M30H ...	258	843546M	257
76410-85	472	7833-12	470	7921-12	495	799A1-33C	287	809622M32H ...	258	843546S	257
76410-09G	473	7833-15	470	7932-04	457	79A21-30	485	82 xxx		843548M	257
76410-14G	473	7833-20	470	7933-45	457	79A22-30	485	820001	58	843548S	257
76412-09	472	7834-50	470	7935-08	457	79B1-01	385	820002	58	843550M	257
76412-10G	473	7842-22	471	7941-08	457	7A xxx		820003	58	843550S	257
76412-14G	473	7842-28	471	7945-07P01	455	7AA105	487	820005	58	843552M	257
7641206P	492	7842-35	471	7946-07	455	7C xxx		820011	58	843552S	257
76414-10	472	7842-45	471	7946-07-S	456	7CA0107M	371	8251-08	211	843554M	257
76414-11G	473	7842-60	471	7962-03	478	7CA0110S	371	8251-16	211	843554S	257
76414-14G	473	7848-60	471	7962-04	478	7CA0606S	372	8260-07	259	843555M	257
76416-12G	473	7848-80	471	7962-06	478	7CA0606S1	372	8260-07P	259	843556S	257
76416-14G	473	7851-08	471	7962-08	478	7CA11-12S	372	8260-10	259	843558M	257
76505-05	472	7851-16	471	7962-12	478	7CA11-15M	372	8260-10P	259	843558S	257
76717-05	474	7851-24	471	7962B-05	478	7CA11-16M	372	8260-13	259	843560M	257
76721-06	474	7851-32	471	7962B-06	478	7CA11-16M	372	8260-13P	259	843560S	257
76724-08	474	7851-40	471	7962B-08	478	7CA11-16S	372	827011	59	843562S	257
76729-10	474	7851-48	471	7962B-10	478	7CA11-20S	372	83 xxx		843564S	257
76804-05	474	7851-64	471	7962B-35	478	7CA11-24S	372	833036M	211	843565M	257
76807-06	474	7852-23	470	7963-03	478	7CA15-10M	373	833038M	211	843566S	257
76B808M	406	7852-55	470	7963-04	478	7CA22BP01	371	833038M	211	843568S	257
76B809M	406	7861-08	470	7963-06	478	7CA22BP10M ..	371	833041M	211	843570S	257
76B812M	406	7861-16	470	7963-08	478	7CA22P01	371	833046M	211	843570M	257
76B813M	406	7861-20	470	7963-12	478	7CA22P20S	371	833046S	211	843572S	257
76B814M	406	7861-24	470	7962B1PR	478	7CA61-A01	372	833048S	211	8462-40P	211
76B815M	406	786P06.....	N17	796401MR	480	7CA61-A011	372	833050M	211	8462DK	211
76B816M	406	79 xxx		7965-02	478	7CA61-A02	372	833054M	211	84700002B	59
76B819M	406	79062-12	483	79711	481	7CA61-A021	372	833054S	211	84700003B	59
76B821M	406	79063-06	484	7971-07	458	7CA61-A03	372	833055M	211	84700011B	59
76C1108M	406	79063-12	484	7971-07P02	458	7CA61-A031	372	833058M	211	85 xxx	
76C1109M	406	79063-20	484	79721	481	7CA61-A04	372	833060M	211	851417M	257
76C1110M	406	79063-40	484	79731	482	7CA61-A041	372	833060S	211	851419M	257
76C1111M	406	79093-02M	482	7977-07	458	7CA61-B01	372	833063M	211	851420M	257
76C1112M	406	79093-03C	482	7977-07-S	458	7CA61-B011	372	833064S	211	851421M	257
76C1113M	406	79093-03M	482	7977-07P02	458	7CA61-B02	372	833065M	211	851422M	257
76C1114M	406	79093-03M	482	7978-07	458	7CA61-B021	372	833067M	211	851426S	257
76C1117M	406	79093-05C	482	7978-07-S	458	7CA61-B03	372	833070M	211	851426S	257
76C1119M	406	79093-05M	482	7978-07P02	458	7CA61-B031	372	833071M	211	852421M	257
76C1121M	406	79093-05M1	482	79815	512	7CA61-B04	372	833071M	211	853417M	258
76C1123M	406	79093-08M	482	79831	512	7CA61-B041	372	833072S	211	853419M	258
76C1124M	406	79093-08C	482	79833	512	7CA61P01	372	833075M	211	853421M	258
77 xxx		79094-02M	482	79900-04	285	7CA61P02	372	833076S	211	853519M	256
7702-25	406	79094-03C	482	79900-10	285	7CA61P03	372	833077M	211	853521M	256
7702-50	406	79094-03M	482	79900-13	285	7CA81-30H	487	833080M	211	853522M	256
7702-75	406	79094-05C	482	79900-20	285	7CA82-30	487	833084S	211	853523M	256
7703-50	406	79094-05C1	482	79901-04	285	7D xxx		833094S	211	853524M	256
7704-50	406	79094-05M	482	79901-10	285	7DM1160	483	8330A0S	211	853524S	256
77131-06	484	79094-08M	482	79901-13	285	7E xxx		84 xxx		853525M	256
77131-08	484	79094-08C	482	79901-20	285	7E61001	496	8404MP.....	260	853526M	256
77141-06	484	79095-05M	482	79901-20	285	7E111	409	84087637BKT ...	42	853526S	256
77141-08	484	79095-05M-S ..	482	79901-30	285	7E111	410	8408MP	260	853527M	256
77328-26	484	7911-12	494	79901-10	285	7E51180-60	407	8408MP02	260	853528M	256
77335-25	484	7912-0111	366	79901-13	285	7E51180-80	407	8409MP	260	853528S	256
77340-20	484	7912-21	366	79901-20	285	7H xxx		8410MP	260	853529M	256
7743-56	406	7912-22	366	79901-30	285	7HA03	373	8410SP	260	853530M	256
7744-60	406	7912-23	366	79901-10	287	7HA11	373	843524M	257	853530S	256
7773GS	187	7912-2311	366	79901-15	287	7HA21	373	843527M	257	853532M	256
78 xxx		7913-42	369	79911-10	287	7K xxx		843528M	257	853532S	256
78106.....	N17	7913-4211	369	79911-10	287	7K09MP	230	843530M	257	853533M	256
7811-08	470	7913A-63	369	79911-15	287	7K09MP01	230	843530S	257	853533M	256
7811-12	470	7913A-6311	369	79911-15	287	80 xx		843530S	257	853534M	256
7811-16	470	7913B-35	368	79912-10	287	8015M	212	843532M	257	853534S	256
7811-24	470	7913B-3511	368	79912-15	287	801524M.....	N14	843533M	257	853535M	256
7811-32	470	7914A-35	367	79912-15	287	801527M.....	N14	843534M	257	853536M	256
7811-40	470	7914A-0111	367	79953-10	286	801530M.....	N14	843534M	257	853536S	256
7811-40	470	7914C-70	367	79953-15	286	801530M.....	N14	843534S	257	853537M	256
7821-30	470	7914C-7021	367	79960-10	286	801532M.....	N14	843535M	257	853538M	256
7821-50	470	7915-30	367	79960-15	286			843536M	257	853538S	256
7821-80	470	7915-3011	367	79960-20	286			843536S	257	853540M	256
				79962-10	286			843538M	257	853540S	256

Index

853541M 256	87102 630	87432-5B 37	87D11-071A-B 32	87SQ32-8B-BK.... N6	9-22308TR 121
853542M 256	87103 630	87432-5B-B 37	87D11-071A-G 32	87SQ32-9B-BK.... N6	9-22308TRV 83
853542S 256	87104 385	87432-5B-G 37	87D11-08A 31	87SQ32-10B-BK.... N6	9-2331SRV 76
853544M 256	87104 630	87432-5G 37	87D11-08SA 31	87SQ33-6B-BK.... N6	9-2516MRV03 90
853544S 256	87105 630	87432-5G-B 37	87D11-09A 31	87SQ33-7B-BK.... N6	9-2524MRV 90
853545M 256	871061A 289	87432-5G-G 37	87D11-09SA 31	87SQ33-8B-BK.... N6	9-2526MR 123
853546M 256	871061A 630	87434-7B 37	87D11-10A 31	87SQ34-10B-BK.... N8	9-2528MRV 90
853546S 256	871061B 289	87434-7B-B 37	87D11-10SA 31		9-2534MRV 76
853548M 256	871061B 630	87434-7B-G 37	87D11-11A-KB 28	88 xxx	9-2544SRV 86
853548S 256	871061F 630	87434-7G 37	87D11-11A-KG 28	8816 211	9-2548CR 111
853550M 256	871061F 289	87434-7G-B 37	87D11-12A-KB 28	883524M 257	9-2548CR01 111
853550S 256	87107 630	87434-7G-G 37	87D11-12A-KG 28	883527M 257	9-2548CRV 70
853552M 256	87108 474	87435-13B 38	87D11-13A-KB 32	883529M 257	9-2548MRV 86
853552S 256	87108 630	87441-1B 43	87D11-13A-KG 32	883530M 257	9-2550MRV 78
853553M 256	87110 630	87441-3B 43	87D11-14A 33	883532M 257	9-2553MRV 87
853554M 256	87111 630	87446-3B-KR 44	87D11-14SA 33	883533M 257	9-2553MRV01 87
853554S 256	87118 482	87446-3B-KB 44	87D11-15A-KB 32	883534M 257	9-2565MRV 76
853555M 256	8711B 630	87452B-B 45	87D11-15A-KG 32	883535M 257	9-25VE01MRV 77
853556S 256	87125 629	87452C-B 45	87D11-16A-B 33	883536M 257	9-30106MR 132
853558M 256	87137 51	87502 47	87D11-16A-G 33	883538M 257	9-30110CR 122
853558S 256	8714101B 51	87502-01 44	87D11-17A-KB 26	883541M 257	9-30206MR 132
853560M 256	87152 629	87502-02 44	87D11-17A-KG 26	8866 259	9-30208MRV 83
853560S 256	87153 629	87502-050 44	87D11-18A-KB 25	8866P 259	9-30216MRV 89
853562S 256	87154 629	87502-051 44	87D11-18A-KG 25	8869 259	9-3023MR01 114
853563M 256	87154-01 289	87502-054 44	87D11-19A-KB 28	8869P 259	9-3023MRV11 .. 87
853564S 256	87154-01 629	87502-058 44	87D11-19A-KG 28		9-30612MRV 85
853565M 256	87156 289	87502-061 44	87D11-20A-K 30	9- xxx	9-30904AY 127
853566M 256	87156 629	87502-064 44	87D11-20LA-K 30	9-1011GP 128	9-30904AY 604
853566S 256	87156A 289	87502-068 44	87D11-21A-KB 26	9-10112MR 124	9-30904AYV 78
853568M 256	87156A 629	87502-11 44	87D11-21A-KG 26	9-10112MRV 77	9-30909AY 127
853568S 256	87157-06 628	87502-12 44	87D11-22A-KB 26	9-10115MR 119	9-30909AY 605
853570M 256	87157-09 628	87502P01 47	87D11-22A-KG 26	9-102A12MR 124	9-30909AYV 79
853570S 256	87162 515	87502P02 46	87D11-23A-KB 30	9-102A15MR 119	9-31006MR 131
853571M 256	87163 515	87502P03 46	87D11-23A-KG 30	9-1044CQV 89	9-31106MR 124
853572S 256	8720 150	87502P011 47	87D11-24A-K 29	9-1112MRV 82	9-31124MRV 75
853574S 256	87201 47	87502P012 47	87D11-25A-KB 29	9-1205MR 116	9-31110MR 122
853575M 256	87203 628	87512 47	87D11-25A-KG 29	9-12110MR 128	9-31110MRV 75
853576S 256	8720813D1 150	8760 208	87D11-26A-K 31	9-12120MR 119	9-31909PR 122
853578S 256	8730 172	8760807D1 208	87D11A-KB 23	9-1215MR03 133	9-31919MR 125
853580M 256	87301-494A 628	87634-7B 38	87D11A-KG 23	9-91215MRV.....N11	9-31920MRV 74
853580S 256	87301-496A 628	87634-7B-B 38	87D11X01SA-KB .. 19	9-1216MR 116	9-34128FR 122
853582S 256	87301-498A 628	87634-7B-G 38	87D11X01SA-KG .. 19	9-1216MR01 116	9-3523MR 114
853584S 256	87301-499A 628	87711C 51	87D11X02SA-KB .. 20	9-1216MR03 116	9-3523MRV10 87
853585M 256	87306-36-B 628	87721B 51	87D11X02SA-KG .. 20	9-1217MR 132	9-3523MRV11 87
853586S 256	87307A 628	87722B 52	87D11X03A-KB .. 21	9-1218MR 116	9-3544MRV 79
853588S 256	8730811D1 172	87723B 53	87D11X03A-KG .. 21	9-1219MR01 116	9-35VE01MRV 78
853590M 256	8740 194	87724D 52	87D11X04A-KB .. 21	9-1220MRV 81	9-35VE02MRV.....N12
853590S 256	87401-2 49	87731D 53	87D11X04A-KG .. 22	9-1272MR 117	9-3612MR 127
853595M 256	87401-3 49	87732D 52	87D11X05A-KB .. 22	9-1282MR 117	9-40102GP 111
853592S 256	87401-3H 49	87733D 52	87D11X05A-KG .. 32	9-12A1MR 129	9-40102GPV 70
853594S 256	87402 50	8779-32F 211	87D11X06A-KB.... 32	9-12A1MRV 82	9-40103GP 124
853596S 256	87404 50	8779DK 211	87D11X06A-KG.... 32	9-12C7MR 127	9-40104GPV 88
8535A0S 256	87405-1 55	8797 259	87D11X06SA-KB .. 32	9-12D20MRV 81	9-40112GPV 70
8535A0M 256	87405-2 55	8797P 259	87D11X06SA-KG .. 32	9-12FVE15MRV ... 84	9-40113GPV 88
8535A4S 256	87405-3 55	87A05 50	87E02-051A 33	9-12FVG15MRV ... 84	9-40122GPV 70
8535A8S 256	87405-9 55	87A051 50	87E02-053A 33	9-1303MR 123	9-40203GP 132
8535B2S 256	87407 50	87A05-KB 50	87E02-061A 33	9-1606MR 132	9-4026MR02 110
85451735M 258	87408 50	87A051-KB 50	87E02-063A 33	9-1606MR01 132	9-40207GP 120
85451941M 258	8740809D1 194	87A08 50	87G001DQ-BK 41	9-1608MR 117	9-40207GP01 120
85452038M 258	87411-6B 48	87C23-B 609	87G11-4B-BK 41	9-1609MR 117	9-4029CR 133
85452041M 258	87411-9B 48	87C24-B 610	87G31-7B-BK 40	9-1709MR 117	9-4057MR 126
85452141M 258	87417-10B 48	87C25-B 610	87G41-B 43	9-1711MR 118	9-40604GP 120
8572-25 211	87419-5B 48	87C34-3B-B 45	87SQ3-11..... N9	9-1716MR 132	9-40606GPV ... 85
8572DK 211	87421-3B 49	87D11-01A-KB 26	87SQ3-12..... N9	9-1812MR 118	9-40618GP 128
8581-26 211	87422-3B 49	87D11-01A-KG 26	87SQ3-13..... N9	9-1838MR 118	9-4116FR 132
87 xxx	87431-5BE 46	87D11-02A-KB 24	87SQ3-22..... N9	9-1905MR 123	9-4116FR03 132
870208 150	87432-15 42	87D11-02A-KG 24	87SQ3-31..... N9	9-1905MR 330	9-4119PR 123
870311 172	87432-17 42	87D11-03A-KB 27	87SQ3-32..... N9	9-1912MR 118	9-4120PR 123
870406 150	87432-23 42	87D11-03A-KG 27	87SQ3-23.....N10	9-1C08MR 119	9-4128FR 124
870406 172	87432-24 42	87D11-04A-KB 27	87SQ3-33.....N10	9-20110MR 124	9-4129PRV 76
870406 194	87432-31 42	87D11-04A-KG 27	87SQ3-41.....N10	9-2044SRV 86	9-4138PR 126
870410 194	87432-32 42	87D11-05A-10 33	87SQ3-42.....N10	9-2048MRV 86	9-4138PRV 76
870422 150	87432-33 42	87D11-05A-KB 27	87SQ3-51.....N10	9-21-20-07MRV .. 89	9-4143FRV 77
870422 172	87432-34 42	87D11-05A-KG 27	87SQ31-6B-BK.... N5	9-22108MR 121	9-4147PRV 88
870422 194	87432-41 42	87D11-06A-B 31	87SQ31-7B-BK.... N5	9-22108MRV 83	9-4156PR 133
	87432-52 42	87D11-06A-G 31	87SQ31-8B-BK.... N5	9-22124MRV50 74	9-42102GPV 70

Index

9-42114GP	111	9-90128SR	111	90405	259	932-010MR	94	9535A4S	261	9A xxx	
9-42114GPV	70	9-90129CR	112	90406	259	932-010MRD	94	9535A5M	261		
9-42116GPV	82	9-90129CRV	71	9052-001MRV.....	56	932-010MR-B	94	9535A6S	261	9A05-062MR	102
9-42144GP	120	9-90131MR	116	9052-001MRV.....	433	932-010MR-G	94	9535A8S	261	9A05-062MR-KB...	102
9-4219MR	131	9-90135MRV	88	9052-002MRV.....	57	934-001MR	98	9535B0M	261	9A05-065MR	103
9-4219MR07	131	9-90135SRV	88	9052-002MRV.....	228	934-001MRD	98	9535B0S	261	9A05-065MR-KB...	103
9-4219SR08	131	9-90138CR	112	90601	245	934-001MR-B	98	9535B2S	261	9A05-068MR	103
9-4221MRV	79	9-90145CRV	71	90602	245	934-001MR-G	98	9535B4S	261	9A05-068MR-KB...	103
9-4235MR	129	9-90154CR	113	90603	254	934-010MRV	63	9535B5M	261	9A05-084MR01...	104
9-4319MR	131	9-90154CR01	113	90604	254	934-010MRV	518	9535B6S	261	9A05-084MR01-KB	104
9-4319MR01	131	9-90205GN	120	90605	259	934-010MRV.....	63	9535B8S	261	9A05-084SR	104
9-4319MR02	131	9-90205GN01	120	90606	259	934-010MRV.....	518	9535C0M	261	9A05-084SR-KB	104
9-4319MR05	131	9-90217GRV	74	90607	254	934-010MRV-B...	63	9535C0S	261	9A05-089MR01	105
9-4328MR	114	9-90220MR	112	90608	236	934-010MRV-B.....	518	9535C2S	261	9A05-089MR01-KB	105
9-4333MR	114	9-90220MR01	112	90609	236	934-010MRV-G	63	9535C4S	261	9A05-103MR	105
9-4333MR03	114	9-90305TQV	89	9063MR	214	934-010MRV-G.....	518	9535C4S	261	9A05-103MR-KB...	105
9-4335MR	129	9-90305TQV01	89	9063MR01	214	934-011MRV	64	9535C5M	261	9A05-109MR	106
9-4338MR	130	9-90310MR	122	908-077CR	107	934-011MRV.....	64	9535C6S	261	9A05-109MR-KB...	106
9-4338MR01	130	9-90315MR	118	908-077CRD	107	934-011MRV-B...	64	9535C8S	261	9A05-132CR	106
9-4338MR03	130	9-90329CR	112	91 xxx		934-011MRV-G...	64	9535D0M	261	9A05-132CR-KB...	106
9-4401MPV	88	9-90408TQ	125	91000M	192	934-011MRV-G...	64	9535D0S	261	9A05-164MR	102
9-4419MPV	81	9-9040SRV	80	91038MY01	445	934-019MRV	65	9535D2S	261	9A05-164MR-KB	102
9-44214GPV	88	9-90413TQV	75	911-000CR	100	934-019MRV.....	65	9535D4S	261	9AA11	549
9-4427MP	126	9-9077CRV	69	911-000CRO2	100	934-019MRV-B ...	65	9535D5M	261	9AA13	549
9-4429MPV	77	9-90VE09CRV.....N12		911-000CRV	67	934-019MRV-G ..	65	9535D6S	261	9AA15	550
9-4435MP	129	9-91016MR	128	911-002CR	100	934-086MRVD.....N11		9535D8S	261	9AA16	549
9-44803AMPV	73	9-91026PR	123	911-003CR	101	934-235MRV.....	62	9535E0M	261	9AA17	550
9-44803AMPV01 ..	73	9-91113SRV	90	911-003CR01	101	934-235MRV-B....	62	9535E0S	261	9AA21	549
9-44805AMPV	73	9-91120MR	119	911-004CRV	67	934-235MRV-G...	62	9535E2S	261	9AA25	550
9-4516MR	113	9-91122MRV	74	9113PR.....	148	935-525CRV	66	9535E4S	261	9AA31	550
9-4522MR	113	9-91124MRV	75	9113PR.....	170	935-525CRVD	66	9535E8S	261	9AA32	550
9-4526MR	110	9-91126SRV	71	9113PR.....	192	94 xxx		9535F0M	261	9AB11	551
9-4526MRV05	79	9-91131MRV	71	91230	440	941-101MRD	95	9535F2S	261	9AB12	551
9-4527MRV02	80	9-91190CRV	83	91232	386	941-101MR	95	9535F6S	261	9AC125-32	552
9-4537MRV	80	9-91215MRV.....N11		91333MQ	445	95 xxx		9535G0S	261	9AC125-40	552
9-4557MR	126	9-91217MRV	75	91422	629	9519MR50	227	9535G4S	261	9AC175-32	552
9-45VE01MRV	78	9-93523MR	115	91431	471	953532M	261	9535G8S	261	9AC175-40	552
9-45VE02MRV	91	9-94435MP	125	91431	628	953533M	261	9535J2S	261	9AC175-66	552
9-4827MP	126	9-94437MRV	73	91432	628	953534M	261	9543MR	226	9AC231-54	552
9-5575MR	115	9-99430MFV	72	91451-01A	289	953536M	261	9563MR	214	9AC2315DK	552
9-55VE01MRV	84	9-99430MFV01	72	91451-01A	628	953538M	261	9563MR01	214	9AD11	552
9-6010MR	133	90 xxx		91451-01B	289	953541M	261	96 xxx		9AE0-6414	558
9-6010MR01	133	901-068MR	99	91451-01B	628	953542M	261	9634-001MR	98	9AE0-7414	558
9-6314MRV	72	901-069MR	99	91451-01F	289	953546M	261	9634-001MR-B	98	9AE1-6414	555
9-6414MP	129	901-073MR	99	91451-01F	628	953550M	261	9634-001MR-G	98	9AE2002	556
9-6414MPV	81	902-062MR	102	91522H	471	953555M	261	9634-008MR	97	9AE2004	556
9-64145P	129	902-062MRD	102	91528H	471	953560M	261	9634-008MR-B	97	9AE2016	556
9-7069CR	110	902-065MR	103	91535H	471	953564S	261	9634-008MR-G	97	9AE2-10615	555
9-7069CR01	110	902-065MRD	103	91545H	471	953565M	261	9634-009MR	93	9AE2-10815	555
9-7069CRV	69	902-068MR	103	91560H	471	953566S	261	9634-009MR-B	93	9AE2-10818	555
9-7078CR	110	902-068MRD	103	91522S	471	953568S	261	9634-009MR-G	93	9AE2-6514	555
9-7078CR01	110	902-084MR01	104	91528S	471	953570M	261	9634-010MR	94	9AE2-6514.....	556
9-7128PR	126	902-084MRD01 ..	104	91535S	471	953570M	261	9634-010MR-B	94	9AE2-6567.....	555
9-7128PRV	77	902-084SR	104	91545S	471	953570S	261	9634-010MR-G	94	9AE2-6567	556
9-7537MR	115	902-084SRD	104	91560S	471	953572S	261	9634-010MRV	518	9AE2-6606	555
9-7540MR	115	902-089MR01	105	919-001CRV	68	953574S	261	9634-010MRV	518	9AE2-6606	556
9-7560MRV01	80	902-089MRD01 ..	105	92 xxx		953575M	261	9634-010MRV-B ..	63	9AE2-6606	556
9-7576MR	125	902-103MR	105	92543MR	229	953576S	261	9634-010MRV-B ..	518	9AE2-7476	555
9-9003MRV01	72	902-103MRD	105	92543MR01	229	953578S	261	9634-010MRV-G...	63	9AE2-7608	555
9-90103PP	121	902-109MR	106	9260-13	260	953580M	261	9634-010MRV-G...	518	9AE2-7612	555
9-90103PP01	121	902-109MRD	106	9260-13P	260	953580S	261	9634-011MRV	64	9AE2-7614	555
9-90103PP02	121	902-132CR	106	93 xxx		953582S	261	9634-011MRV-B...	64	9AE2-7614	556
9-90103RR	121	902-132CRD	106	932-000MR	96	953584S	261	9634-011MRV-G...	64	9AE2-8616	555
9-90104GP	130	902-164MR	102	932-000MRD	96	953585M	261	9634-011MRV-G...	64	9AE2-8618	555
9-90106SR	121	902-164MRD	102	932-000MR-B	96	953588S	261	9634-019MRV	65	9AE2-9210	555
9-90109MN	119	90217PQ	444	932-000MR-G	96	953590M	261	9634-019MRV-B...	65	9AE2-9315	555
9-90111MR	133	90217PQ01	444	932-008MR	97	953590S	261	9634-235MRV	62	9AE2-9315	556
9-90113MA	131	90217PQ03	444	932-008MRD	97	953592S	261	9634-235MRV-B...	62	9AE2-9345	556
9-90114MR	128	9033CR	214	932-008MR	97	953594S	261	9634-235MRV-G...	62	9AE2-9618	555
9-90115MR	132	90401	245	932-008MR-B	97	953595M	261	9644-101MR	95	9AE2-10615	555
9-90118PRV	89	90402	245	932-008MR-G	97	953596S	261	97 xxx		9AE2-10815	555
9-90119MRV	82	90403	254	932-009MR	93	953598S	261	97121PQ	444	9AE2-10818	555
9-90120MR	132	9043MR	226	932-009MRD	93	9535A0M	261	98 xxx		9AE221	557
9-90121MR	130	90404	254	932-009MR-B	93	9535A0S	261	9868	260	9AE221	562
9-90125MR	132	90405	254	932-009MR-G	93	9535A2S	261	9868P	260	9AE31-73	552
9-90126MR	130										

Index

9AE31-85	552	9AH0331	565	9AT2107E	524	9BC5110M	577	9BU251	589	9DC22	598
9AE31-95	552	9AH31	566	9AT2-A01	528	9BC5111M	577	9BU251T	589	9DC23	597
9AE31-111	552	9AH41	567	9AT2-A01	530	9BD101	577	9BU252	589	9DC242	598
9AE31-121	552	9AJ017	566	9AT2-A01	533	9BE11	578	9BU252T	589	9DC243	598
9AE31-134	552	9AJ3122	566	9AT2-A01	536	9BE21	578	9BU41	590	9DC51	599
9AE31X-120.....N23		9AJ3122A	567	9AT2-A01	544	9BE41	578	9BU8109	285	9DD21	599
9AE31X-135.....N23		9AJ3127	567	9AT2-C01	532	9BE42	578	9BU8109	589	9DD22	599
9AE31X-145.....N23		9AJ3222	567	9AT2-C01	541	9BE43	578	9BU8112	285	9DH11	599
9AE32-110	553	9AJ3322	567	9AT2-D01	526	9BE44	578	9BU8112	589	9DM1361	447
9AE32-155	553	9AJ4122	567	9AT2-D01	534	9BE45	578	9BU8209	285	9DM1381	447
9AE33-110	553	9AJ4227	567	9AT2-D01	545	9BE51	579	9BU8209	589	9DM1A1	599
9AE33-155	553	9AJ4229	567	9AT2-E01	545	9BE52	579	9BU8212	285	9DM2351	448
9AE42	562	9AJ4322	566	9AT3-A01	545	9BE62	579	9BU8212	589	9DN12	450
9AE43	562	9AK11	568	9AT3-A02	546	9BE63	579	9BV1420	284	9DP1101	600
9AE433	557	9AK21	568	9AT3-A03	536	9BF11	580	9BV1420T	285	9DP1301	600
9AE433	560	9AL11	568	9AT3-A04	546	9BF21	580	9BW0120	584	9DP1302	600
9AE433	562	9AL12	568	9AT3-B01	546	9BF31	580	9BW0220	284	9DP2301	600
9AE52	562	9AM010	568	9AT3-F01	546	9BF33	581	9BW0221	584	9DP3201	601
9AE52-110	562	9AM011	568	9AT3-F02	546	9BG11	580	9BW4501	586	9DT11	601
9AE53-115	562	9AM012	564	9AT3-E01	533	9BK11	581	9BW4502	586	9DT11-1	601
9AE6002	559	9AN021	567	9AT3-E02	528	9BK31	581	9BW4801	586	9DT11-2	601
9AE6030	560	9AN4128	567	9AT3-E02	530	9BK32	549	9C xxx		9DT11-3	601
9AE6-6514	558	9AN4227	567	9AT3-E02	537	9BK41	581	9CD14	595	9DT11-4	601
9AE6-6514	559	9AN43	539	9AW4901	571	9BK41-20	581	9CD21	595	9DT11-5	601
9AE6-6514A	558	9AP100	569	9AW4911	571	9BK41-28	581	9CD31	596	9DT11-6	601
9AE6-6567	558	9AP120	569	9B xxx		9BK41-38	581	9CF-107	592	9DT11-7	601
9AE6-6567	558	9AP160	569	9BA01	479	9BK41-53	581	9CF110	591	9DT11-8	601
9AE6-6606	558	9AR11	569	9BA02	480	9BK41-65	581	9CF120	591	9DT11-9	601
9AE6-6814	558	9AR21	569	9BA03	480	9BK41-73	582	9CF130	591	9DT11-10	601
9AE6-7314	538	9AR29-S	569	9BA11	571	9BK43	581	9CF131	591	9DT11-11	601
9AE6-7414	558	9AS11	569	9BA21	479	9BK43-65	581	9CF132	591	9DT11-12	601
9AE6-7415	558	9AT1002E	529	9BA21P01	479	9BK7008	587	9CF-207	592	9H xxx	
9AE6-7476	558	9AT1002E	541	9BA21P011	479	9BK7009	587	9CF210	591	9HBE083	579
9AE6-7577	558	9AT1007E	542	9BA21P02	479	9BK711	587	9CF220	592	9HBE4-30	578
9AE6-7608	558	9AT1009E	520	9BA21P03	479	9BK72	587	9CF230	592	9HBE4-39	578
9AE6-7612	558	9AT1010E	523	9BA21P04	479	9BK72-12	587	9CF240	592	9HBE4-47	578
9AE6-7614	558	9AT1010E	527	9BA21P05	479	9BK72-13	587	9CF241	592	9HBE4-58	578
9AE6-7630	558	9AT1018E	519	9BA21P06	479	9BK72-14	587	9CF-307	592	9HBE4-62	578
9AE6-7815	558	9AT1021E	528	9BA21P07	479	9BK72-16	587	9CH01	593	9HBE4-67	578
9AE6-8015	558	9AT1026E	531	9BA22	479	9BK72-22	587	9CH212	593	9HBE81	579
9AE6-8082	531	9AT1102E	521	9BA22P01	479	9BK72-28	587	9CI016	595	9HBL11-05	583
9AE6-8414	558	9AT1103E	538	9BA22P011	479	9BK73-14	587	9CJ013	594	9HBL12-05	583
9AE6-8616	558	9AT1105E	532	9BA22P02	479	9BK73-22	587	9CJ023	594	9HBN01	580
9AE6-8618	559	9AT1106E	521	9BA22P04	479	9BM120	582	9CJ072.....N21		9T xxx	
9AE6-9015	559	9AT1108E	523	9BA31	480	9BM2-01	286	9CJ7416.....N21		9TA242A	505
9AE6-9210	559	9AT1112E	527	9BA32	480	9BM2-02	286	9CJ7432.....N21		9TA242B	505
9AE6-9315	559	9AT1202	526	9BA33	480	9BM2-02	583	9CJ033	595	9TA242D	505
9AE6-9336	559	9AT1202	543	9BA41	572	9BM2110	286	9CJ1112	593	9TA251A	507
9AE6-9345	559	9AT1206E	542	9BB11	572	9BM2110	583	9CJ1120	593	9TA251B	507
9AE6-9515	559	9AT1306E	547	9BB12	573	9BM2111	286	9CJ1130	594	9TA251D	507
9AE6-9618	559	9AT1406E	531	9BB13	573	9BM2111	583	9CJ2112	594	9TA261A	506
9AE6-10015	559	9AT1506E	547	9BB31	573	9BM2210	286	9CJ2120	594	9TA261B	506
9AE6-10615	559	9AT1606E	525	9BB42	571	9BM2210	583	9CJ2212	594	9TA261D	506
9AE6-10815	559	9AT1706E	525	9BC11	574	9BM2210A	286	9CJ3104	594	9TA265	506
9AE6-10818	563	9AT1-A01	540	9BC121	574	9BM2210A	583	9CJ3105	594	9TA266	506
9AE71-90	563	9AT1-A02	526	9BC124	574	9BM2211	286	9CJ3106	595	9TA267W	502
9AE71-115	563	9AT1-A03	536	9BC21	574	9BM2211	583	9CJ61-40	595	9TA268A	506
9AE71-140	563	9AT1-A04	541	9BC22	574	9BM2211A	286	9CK-101	601	9TA268B	506
9AE72	563	9AT1-E01	530	9BC23	575	9BM2211A	583	9CM01	593	9TA268D	506
9AE8006	561	9AT1-E01	534	9BC24A	575	9BM811	582	9CM11	593	9TA271.....N19	
9AE8-24	561	9AT2004E	538	9BC251	576	9BP11	573	9CM209	593	9TA28	511
9AE8-27	561	9AT2004E	543	9BC251A01	576	9BP21	573	9CM212	593	9TA281	511
9AE8-30	561	9AT2005E	538	9BC26	576	9BQ01	590	9CW01	596	9TA33A	508
9AE8-32	561	9AT2005E	543	9BC32	576	9BQ11	590	9CW11	596	9TA33B	508
9AE8-36	561	9AT2006E	519	9BC32P021	577	9BT250	590	9CW12	596	9TA33D	508
9AE8-38	563	9AT2006E	529	9BC41A14.....N14		9BT2100	590	9CW13	596	9TA34A	508
9AF11-15	563	9AT2006E	533	9BC41A22.....N14		9BU111	588	9CW21	596	9TA34B	508
9AF11-30	563	9AT2008E	535	9BC42A11.....N14		9BU111T	588	9CW22	596	9TA34D	508
9AF11-60	563	9AT2008E	537	9BC42A15.....N14		9BU112	588	9CZ101	601	9TA34P01	508
9AF113	564	9AT2008E	544	9BC42A20.....N14		9BU112T	588	9CZ201-S	489	9TA42A	513
9AG11	564	9AT2010E	540	9BC4A05MP.....N14		9BU1432T	588	9D xxx		9TA42B	513
9AG13	565	9AT2011E	532	9BC5001MR	577	9BU241	589	9DA022	597	9TA42D	513
9AH12	565	9AT2012E	539	9BC5107M	577	9BU241T	589	9DA103	597	9TA44W	503
9AH025	565	9AT2106E	522	9BC5108M	577	9BU242	589	9DA104	597	9TA45A	514
9AH0311	566	9AT2106E	534	9BC5109M	577	9BU242T	589	9DB201	597	9TA46A	514
9AH0321	566	9AT2106E	544								

Index

9TA48A.....N20	9TK236B 603	A535145M 262	B535125M 263	ST114519MR 620	ZS141-2L 626
9TA48B.....N20	9TK306 603	A535148S 262	B535130M 263	ST20109MR 621	ZS141-3L 626
9TA48C.....N20	9TK312 603	A535150M 262	B535132S 263	ST20203MR 621	ZS142B-S 626
9TA52A 510	9TK316 603	A535155M 262	B535135M 263	ST20203SR 621	ZS142B-M 626
9TA52B 510	9TK320 603	A535156S 262	B535136S 263	ST20208MY 620	ZS142B-L 626
9TA52D 510	9TP11 610	A535160M 262	B535140M 263	ST20209MR 620	ZS142B-XL 626
9TA53 510	9TP12 610	A535160S 262	B535140S 263	ST20213MR 620	ZS142B-2L 626
9TA54 509	9TP22 610	A535164S 262	B535144S 263	ST20219MR 620	ZS142B-3L 626
9TA56 509	9TQ02 607	A535165M 262	B535145M 263	ST20219MY 620	ZS142G-S 626
9TA71W 504	9TQ11 607	A535168S 262	B535148S 263	ST20419PR 621	ZS142G-M 626
9TA92WA 504	9TQ12 607	A535170M 262	B535150M 263	ST2346MR 615	ZS142G-L 626
9TA92WB 504	9TQ21 606	A535172S 262	B535152S 263	ST4028MR 615	ZS142G-XL 626
9TA92WD 504	9TQ31 602	A535175M 262	B535156S 263	ST4028SR 615	ZS142G-2L 626
9TB225 602	9TT11-18 611	A535180M 262	B535160M 263	ST4528MR 615	ZS142G-3L 626
9TB500 602	9TT21-03 611	A535180S 262	B535160S 263	ST4528SR 615	ZS142W-S 626
9TBA600 602	9TT31-20 611	A535184S 262	B535164S 263	ST87432-5B 621	ZS142W-M 626
9TBA650 602	9TU11-20 613	A535185M 262	B535165M 263	ST87434-7B 621	ZS142W-L 626
9TC101 602	9TU21-20 613	A535188S 262	B535168S 263		ZS142W-XL 626
9TD014MR 492	9TV13-100 612	A535190M 262	B535170M 263	SY xxx	ZS142W-2L 626
9TD033MR.....N20	9TV21-09 612	A535192S 262	B535172S 263	SY-10A 288	ZS142W-3L 626
9TD034MR 491	9TW21-20 613	A535196S 262	B535175M 263	SY-20A 288	ZS146-S 626
9TD035MR 491	9TZ11-04 489	A535200M 262	B535176S 263	SY-210H 288	ZS146-M 626
9TD036MR 491	9TZ11-05 489	A535200S 262	B535180M 263	SY-210M 288	ZS146-L 626
9TD062 491	9TZ11-06 489	A535204S 262	B535180S 263	SY-211F 288	ZS146-XL 626
9TD064 491	9TZ11-08 489	A535208S 262	B535184S 263	SY-211H 288	ZS146-2L 626
9TD164MR 492	9TZ11-10 489	A535210M 262	B535185M 263	SY-211M 288	ZS155 625
9TD165MR 492	9TZ11-12 489	A535212S 262	B535188S 263	SY-220H 288	ZS155A 625
9TD401-06M 492		A535215M 262	B535190M 263	SY-221H 288	ZS306 624
9TD401-08M 492	9X xxx	A535216S 262	B535192S 263	SY-221M 288	ZS402 624
9TD401-10M 492	9XAH1 564	A535220S 262	B535196S 263	SY-221F 288	ZS405 624
9TD401-12M 492	A5 xxx	A535224S 262	B535200M 263	SY-230M 288	ZS408 624
9TD403-10M 491	A535041M 262	A535225M 262	B535200S 263	SY-231M 288	ZS409 624
9TD403-12M 491	A535046M 262	A535235M 262	B535204S 263	SY-231F 288	ZS410 624
9TD403-13M 491	A535050M 262	A535240S 262	B535208S 263	SY-260M 288	ZS411 624
9TD403-14M 491	A535051M 262	A535244S 262	B535210M 263	SY-310H 288	ZS417 N22
9TD403-17M 491	A535055M 262	A535252S 262	B535212S 263	SY-311H 288	ZS417 625
9TD403-19M 491	A535057M 262	A535256S 262	B535215M 263	SY-320H 288	ZS418K N22
9TD403-21M 491	A535060M 262		B535216S 263	SY-321H 288	ZS418K 624
9TD403-22M 491	A535065M 262	AD xxx	B535220S 263	SY-410H 288	ZS511 625
9TD403-23M 491	A535070M 262	ADCV-01 627	B535224S 263	SY-411H 288	ZS514 625
9TD403-24M 491	A535075M 262	ADCV-02 627	B535225M 263	SY-421M 288	ZS517 624
9TD403-27M 491	A535076M 262	ADFLAG 627	B535228S 263		ZS522 625
9TD404-0619M 492	A535076S 262	ADFLAG1 627	B535232S 263	TS xxx	ZS524 625
9TD601 491	A535077M 262	ADFLAG2 627	B535235M 263	TS00108 622	ZS533 625
9TD602 491	A535078S 262	ADSTK21KT 627	B535236S 263	TS00208 623	ZS540 625
9TD603 491	A535080M 262	ADSTK22KT 627	B535240S 263		ZS572 625
9TD604 491	A535080S 262	ADSTK23KT 627	B535244S 263	WS xxx	ZS606 N22
9TE11 486	A535082S 262	ADSTK31KT 627	B535248S 263	WSB012802-5 ... 585	ZS606 625
9TE41 244	A535084S 262	ADSTK-C1 627	B535252S 263	WSB013006-5 ... 585	
9TE41 609	A535085M 262	ADSTK-H2 627	B535256S 263	WSB022701-5 ... 585	ZV xxx
9TG11 609	A535086M 262	ADV-01 627	B535260S 263	WSN043601-5 ... 585	ZV011 314
9TG12 609	A535088S 262	ADV-02 627	B535264S 263	WSN043602-5 ... 585	ZV011A 314
9TG21 609	A535090M 262	ADV-031.....N23	B535268S 263	WSN043603-5 ... 585	ZV011B 314
9TH21-XL 486	A535090S 262	ADV-032.....N23	B535272S 263	WSN043604-5 ... 585	ZV012 314
9TH31-XL 486	A535094S 262	ADV-033.....N23	B535276S 263		ZV012A 314
9TH31-2L 486	A535095M 262	ADV-034.....N23	B535280S 263	ZS xxx	ZV012B 314
9TH41-L 486	A535096S 262	ADV-035.....N23	B535284S 263	ZS104 624	ZV012D 314
9TH41-XL 486	A535100M 262	ADV-036.....N23		ZS107 624	ZV013 314
9TH42-XL 486	A535100S 262	ADV-037.....N23	SC xxx	ZS108 624	ZV013A 314
9TH42-XXL 486	A535105M 262	ADV-038.....N23	SC7083MR 618	ZS109-L 626	ZV013B 314
9TH43-XL 486	A535108S 262	ADV-039.....N23	SC7096MR 616	ZS109-XL 626	ZV013D 314
9TH43-XXL 486	A535110M 262	ADV-040.....N23	SC7010MR 617	ZS109-2L 626	
9TH44-XL 487	A535112S 262	ADV-041.....N23	SC7396MR 616	ZS109-3L 626	
9TH44-XXL 487	A535115M 262	ADV-042.....N23	SC7510MR 618	ZS110 626	
9TH45-XL 487	A535120M 262	ADV-043.....N23	SC7583MR 616	ZS111 627	
9TH45-XXL 487	A535120S 262	ADV-044.....N23	SC7596MR 617	ZS112-L 626	
9TK014 603	A535120S 262	ADV-045.....N23	SC9043MR 619	ZS112-XL 626	
9TK024 603	A535124S 262	ADV-046.....N23	SC9543MR 619	ZS112-2L 626	
9TK034 603	A535125M 262	ADV-047.....N23		ZS112-3L 626	
9TK108 603	A535126S 262	ADV-048.....N23	ST xxx	ZS115 627	
9TK112 603	A535130M 262	ADV-049.....N23	ST112012MR 620	ZS115-1 627	
9TK118 603	A535132S 262	ADV-050.....N23	ST112014MR 620	ZS116 625	
9TK124 603	A535135M 262		ST112017MR 620	ZS119 625	
9TK225A 603	A535136S 262	B5 xxx	ST112019MR 620	ZS120-S N22	
9TK225B 603	A535138S 262	B535105M 263	ST114512MR 620	ZS120-S 625	
9TK236A 603	A535140M 262	B535110M 263	ST114514MR 620	ZS141-S 626	
	A535144S 262	B535115M 263	ST114517MR 620	ZS141-M 626	
		B535120M 263		ZS141-L 626	
				ZS141-XL 626	

KING TONY Tools Corporation

Green Space for The Mind

The tall rich green grasses around us grow and give us a sense of a fresh, free feeling, as the gentle winds blow. As the tall grasses grow to reach the blue sky, so do our desires, minds, and work to reach the highest quality of service.

- KING TONY reserve the revising right to the listing product in this catalogue for improving or technical reasons.
- All products listed in catalogues before this version are null and void unless items confirming remain available by KING TONY.
- Do not copy or extract any listing in the catalogue without our approval.



Quality
Innovation
Health
Enjoyment

 **KING TONY TOOLS CO.,LTD.**



<http://www.kingtony.com>

✉ service@kingtony.com.tw

facebook  **YouTube**

king tony

 **Instagram**

kingtonytools